



2	Multilayer Ferrite Chip Beads [SB/PB/UP/NB/GB Series]
22	Multilayer Ferrite Chip Beads [BA Series]
26	Surface Mount Beads [FB Series]
30	EMI PC Beads [SBC Series]
33	Data Line EMI Filter [SBCB Series]
36	EMC Data Line Filter [SBCB Series]
40	Multilayer Chip Inductors [CL Series]
47	Miniature Surface Mount Chip Inductors [SQV Series]
51	Miniature Surface Mount Chip Inductors [SQC Series]
55	Wound Chip Inductors [NL Series]
66	Wound Chip Inductors [NLC Series]
74	Multilayer Chip Inductors High Frequency [CLH Series]
85	Wound Chip Inductors High Frequency [CS/LCN Series]
100	DIP Power Inductors [PMC Series]
101	SMT Power Inductors [SPMC Series]
102	DIP Power Inductors [MBPL Series]
105	Mini Power Inductors [GAB0312 Series]
106	Mini Power Inductors [NDA Series]
108	Mini Power Inductors [NAN Series]
111	SMD Power Inductors [NAS Series]
115	SMT Power Inductors [SCD Series]
123	SMT Power Inductors [SCDS Series]
129	Shielded SMD Power Inductors [SCDS Series]
135	UnShielded SMD Power Inductors [SCMD Series]
137	SMD Power Inductors [SDS0402 Series]
138	Shielded SMD Power Inductors [SDS0402BL Series]
139	SMD Power Inductors [SDS0804 Series]
140	SMD Power Inductors [SDS1306 Series]
144	SMD Power Inductors [SLF Series]
152	SMD Power Inductors [SDT0402 Series]
154	SMD Power Inductors [SDT0804 Series]
158	SMD Power Inductors [SSL0618 Series]
159	SMD Power Inductors [SSL0400 Series]
161	UnShielded SMD Power Inductors [SSL04LP Series]
163	SMD Power Inductors [SSL0401 Series]
164	SMD Power Inductors [SSL0402 Series]
165	SMD Power Inductors [SSL0802 Series]
166	SMD Power Inductors [SSL0804 Series]
167	SMD Power Inductors [SSL0810 Series]
168	SMD Power Inductors [SSL1306 Series]
173	SMD Power Inductors [SSL0503HC Series]
174	SMD Power Inductors [SSL0804HC Series]
175	SMD Power Inductors [SSL1306HC Series]
179	SMD Power Inductors [STD0804 Series]
180	SMD Power Inductors [STD1109 Series]

Multilayer Ferrite Chip Beads

SB/PB/UP/NB/GB Series

[SB Series for General Purpose / PB Series for Large Current / UP Series for Ultra High Current / NB Series for Data Line, Digital Signals, etc. / GB Series for Medium Current]

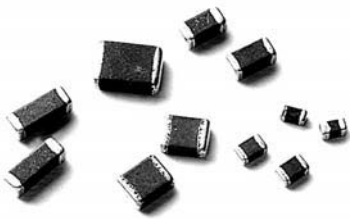

OUTLINE

Yageo offers hundreds of multi-layered ferrite chip beads with various sizes, frequency characteristics, and a board range of impedance values to provide a powerful solutions for EMI problems.

Three formulas of ferrite comprise several types of EMI suppression chip beads that are classified into six categories – SB, GB, PB, UP, NB and BA series.

PRODUCT IDENTIFICATION

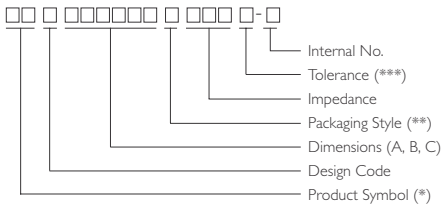

* SB, PB, UP, NB, GB

** T : Tape and Reel; B : Bulk

*** Y = ±25%; M = ±20%

SHAPES AND DIMENSIONS

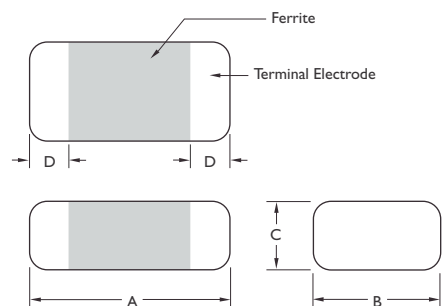

Dimensions : mm

TYPE		A	B	C	D
SB/PB/NB	100505	1.0 ± 0.10	0.50 ± 0.10	0.5 ± 0.10	0.25 ± 0.10
SB/PB/UP/NB/GB	160808	1.6 ± 0.20	0.80 ± 0.15	0.8 ± 0.15	0.3 ± 0.2
SB/PB/UP/NB/GB	201209	2.0 ± 0.20	1.25 ± 0.20	0.9 ± 0.20	0.5 ± 0.3
SB/PB/UP/NB/GB	321611	3.2 ± 0.20	1.60 ± 0.20	1.1 ± 0.20	0.5 ± 0.3
SB/GB	321616	3.2 ± 0.20	1.60 ± 0.20	1.6 ± 0.20	0.5 ± 0.3
SB/GB	322513	3.2 ± 0.20	2.50 ± 0.20	1.3 ± 0.20	0.5 ± 0.3
SB/PB/GB	451616	4.5 ± 0.25	1.60 ± 0.20	1.6 ± 0.20	0.5 ± 0.3
SB/PB/GB	453215	4.5 ± 0.25	3.20 ± 0.20	1.5 ± 0.20	0.5 ± 0.3



SB SERIES, FOR GENERAL USE

APPLICATIONS

I/O Ports, DC Power Lines, and Signal Lines
 Computer and Peripheral Products
 Consumer Electronic Products

FEATURES

Standard type used to suppress lower-frequency, lower current signals.
 Impedance over a Broad Frequency Range
 Suitable for Flow and Reflow Soldering
 Available in 8 Sizes

ELECTRICAL CHARACTERISTICS

PART NO.	IMPEDANCE at 100MHz ($\Omega \pm 25\%$)	DC RESISTANCE (Ω) Max.	RATED CURRENT (mA) Max.	PART NO.	IMPEDANCE at 100MHz ($\Omega \pm 25\%$)	DC RESISTANCE (Ω) Max.	RATED CURRENT (mA) Max.
SBY100505T-060Y-S	6	0.05	500	SBK201209T-751Y-S	750	0.50	200
SBY100505T-100Y-S	10	0.05	500	SBK201209T-102Y-S	1000	0.50	200
SBY100505T-400Y-S	40	0.30	300	SBK201209T-152Y-S	1500	0.60	200
SBY100505T-800Y-S	80	0.40	200	SBK201209T-202Y-S	2000	0.80	100
SBY100505T-121Y-S	120	0.50	200	SBK201209T-222Y-S	2200	1.00	100
SBY100505T-241Y-S	240	0.50	200	SBK201209T-252Y-S	2500	1.00	100
SBY100505T-481Y-S	480	0.80	100	SBK201209T-272Y-S	2700	1.50	100
SBY100505T-601Y-S	600	1.00	100	SBY321611T-190Y-S	19	0.05	600
SBY100505T-102Y-S	1000	1.50	100	SBY321611T-260Y-S	26	0.05	600
SBY100505T-152Y-S	1500	2.00	60	SBY321611T-320Y-S	32	0.05	600
SBK160808T-110Y-S	11	0.05	500	SBY321611T-500Y-S	50	0.10	500
SBK160808T-190Y-S	19	0.08	500	SBY321611T-600Y-S	60	0.10	500
SBK160808T-300Y-S	30	0.10	400	SBK321611T-700Y-S	70	0.10	500
SBK160808T-400Y-S	40	0.10	400	SBK321611T-900Y-S	90	0.15	500
SBK160808T-600Y-S	60	0.10	300	SBK321611T-121Y-S	120	0.15	500
SBK160808T-800Y-S	80	0.15	300	SBK321611T-151Y-S	150	0.15	500
SBK160808T-121Y-S	120	0.25	300	SBK321611T-201Y-S	200	0.20	400
SBK160808T-221Y-S	220	0.30	200	SBK321611T-401Y-S	400	0.20	400
SBK160808T-301Y-S	300	0.40	200	SBK321611T-501Y-S	500	0.20	400
SBK160808T-451Y-S	450	0.50	200	SBK321611T-601Y-S	600	0.30	400
SBK160808T-601Y-S	600	0.50	200	SBK321611T-102Y-S	1000 *	0.40	200
SBK160808T-751Y-S	750	0.70	200	SBK321611T-122Y-S	1200 *	0.40	200
SBK160808T-102Y-S	1000	0.70	200	SBK321611T-152Y-S	1500 *	0.45	200
SBK160808T-152Y-S	1500	1.00	50	SBK321611T-202Y-S	2000 **	0.60	200
SBK160808T-222Y-S	2200	1.20	50	SBK321611T-272Y-S	2700 **	0.60	200
SBK160808T-272Y-S	2700	1.30	50	SBY321616T-250Y-S	25	0.10	500
SBY201209T-070Y-S	7	0.10	600	SBY321616T-600Y-S	60	0.20	500
SBY201209T-090Y-S	9	0.10	600	SBK321616T-700Y-S	70	0.20	500
SBY201209T-110Y-S	11	0.10	600	SBY322513T-320Y-S	32	0.20	500
SBY201209T-170Y-S	17	0.10	600	SBY322513T-600Y-S	60	0.20	500
SBY201209T-320Y-S	32	0.10	600	SBY322513T-900Y-S	90	0.20	500
SBK201209T-600Y-S	60	0.15	500	SBY451616T-500Y-S	50	0.20	600
SBK201209T-700Y-S	70	0.15	500	SBY451616T-600Y-S	60	0.20	600
SBK201209T-800Y-S	80	0.15	500	SBY451616T-800Y-S	80	0.20	600
SBK201209T-121Y-S	120	0.25	300	SBY451616T-101Y-S	100	0.30	500
SBK201209T-151Y-S	150	0.25	300	SBK451616T-151Y-S	150	0.30	500
SBK201209T-221Y-S	220	0.30	300	SBK451616T-171Y-S	170	0.30	500
SBK201209T-301Y-S	300	0.30	300	SBY453215T-700Y-S	70	0.30	500
SBK201209T-401Y-S	400	0.30	300	SBY453215T-121Y-S	120	0.30	500
SBK201209T-501Y-S	500	0.40	300				
SBK201209T-601Y-S	600	0.40	300				

Note : * at 50MHz ** at 30MHz



PB SERIES, FOR HIGH CURRENT USE

APPLICATIONS

High current DC power lines for USB interface circuitry, personal computers, electronic games, hard disk drives, and other general electronic equipments.

FEATURES

Suitable for High Current Applications
Small Package Size-EIA STD 0402/0603/0805/1206/1806 and 1812
Nickel Barrier Terminations Provide Excellent Solder Heat Resistance
Current Rating up to 6 AMPS (Max) (High Current Handling Capacity)
Low DCR
Suitable for Flow and Reflow Soldering
Available in 6 Sizes

ELECTRICAL CHARACTERISTICS

PART NO.	IMPEDANCE at 100MHz ($\Omega \pm 25\%$)	DC RESISTANCE (Ω) Max.	RATED CURRENT (mA) Max.
PBY100505T-100Y-S	10	0.03	1000
PBY160808T-110Y-S	11	0.02	4000
PBY160808T-250Y-S	25	0.03	3000
PBY160808T-400Y-S	40	0.035	3000
PBY160808T-600Y-S	60	0.04	3000
PBY160808T-121Y-S	120	0.08	2500
PBY160808T-301Y-S	300	0.10	2000
PBY160808T-501Y-S	500	0.15	1500
PBY160808T-601Y-S	600	0.20	1000
PBY160808T-102Y-S	1000	0.25	800
PBY201209T-110Y-S	11	0.01	6000
PBY201209T-170Y-S	17	0.02	5000
PBY201209T-300Y-S	30	0.02	4000
PBY201209T-500Y-S	50	0.025	3000
PBY201209T-600Y-S	60	0.03	3000
PBY201209T-800Y-S	80	0.04	3000
PBY201209T-121Y-S	120	0.04	3000
PBY201209T-201Y-S	200	0.05	2500
PBY201209T-301Y-S	300	0.08	2000
PBY201209T-601Y-S	600	0.10	2000
PBY201209T-102Y-S	1000	0.12	1500
PBY321611T-190Y-S	19	0.015	6000
PBY321611T-320Y-S	32	0.015	4000
PBY321611T-500Y-S	50	0.02	4000
PBY321611T-800Y-S	80	0.025	3000
PBY321611T-101Y-S	100	0.03	2500
PBY321611T-301Y-S	300	0.06	2000
PBY321611T-601Y-S	600	0.10	1800
PBY321611T-102Y-S	1000 *	0.15	1200
PBY321611T-122Y-S	1200 *	0.18	1000
PBY321611T-152Y-S	1500 *	0.20	800
PBY322513T-600Y-S	60	0.025	4000
PBY322513T-900Y-S	90	0.025	3000
PBY451616T-500Y-S	50	0.020	6000
PBY451616T-600Y-S	60	0.020	5000
PBY451616T-800Y-S	80	0.025	4000
PBY451616T-151Y-S	150	0.100	2000
PBY453215T-700Y-S	70	0.03	6000
PBY453215T-121Y-S	120	0.03	4000

Note : * at 50MHz



UPB SERIES, FOR ULTRA HIGH CURRENT USE

APPLICATIONS

Preventing of Electronics Magnet Interference in Power Line of PC, Printer, & CD ROM

High Frequency Filtering of Medium Speed Clocks and Video Signals

FEATURES

High Current Performance

Low D.C. Resistance Minute $m\Omega$ Typically

Impedance Character of Broad Frequency

ELECTRICAL CHARACTERISTICS

PART NO.	IMPEDANCE at 100MHz ($\Omega \pm 25\%$)	DC RESISTANCE (Ω) Max.	RATED CURRENT (mA) Max.
UPB160808T-250Y-S	25	0.015	4500
UPB160808T-300Y-S	30	0.015	4500
UPB201209T-400Y-S	40	0.015	5000
UPB201209T-500Y-S	50	0.015	5000
UPB201209T-600Y-S	60	0.020	4500
UPB321611T-600Y-S	60	0.012	6000
UPB321611T-800Y-S	80	0.012	6000
UPB321611T-101Y-S	100	0.012	6000
UPB321611T-121Y-S	120	0.012	6000
UPB321611T-151Y-S	150	0.020	4500



NB SERIES, FOR HIGH SPEED SIGNALS USE

APPLICATIONS

High Speed Circuits for Computer & Peripheral Equipments and Communication Devices

Cellular Phone

Suitable for Circuits with Unstable Ground

FEATURES

Exhibiting High Impedance with Sharp Increase at High Speed Signal Frequencies with Minimal Diminishing the Desired Wave Form

Suitable for Flow and Reflow Soldering

Available in 4 Sizes

ELECTRICAL CHARACTERISTICS

PART NO.	IMPEDANCE at 100MHz ($\Omega \pm 25\%$)	DC RESISTANCE (Ω) Max.	RATED CURRENT (mA) Max.
NBQ100505T-060Y-S	6	0.10	300
NBQ100505T-100Y-S	10	0.20	200
NBQ100505T-400Y-S	40	0.40	150
NBQ100505T-800Y-S	80	0.60	100
NBQ100505T-121Y-S	120	0.80	50
NBQ160808T-060Y-S	6	0.05	500
NBQ160808T-100Y-S	10	0.07	400
NBQ160808T-400Y-S	40	0.30	300
NBQ160808T-600Y-S	60	0.30	300
NBQ160808T-800Y-S	80	0.40	300
NBQ160808T-121Y-S	120	0.40	300
NBQ160808T-241Y-S	240	0.40	200
NBQ160808T-301Y-S	300	0.50	200
NBQ160808T-481Y-S	480	0.60	150
NBQ160808T-601Y-S	600	0.60	100
NBQ160808T-102Y-S	1000	0.70	100
NBQ160808T-122Y-S	1200	0.70	100
NBQ160808T-152Y-S	1500	0.80	100
NBQ160808T-182Y-S	1800	0.95	100
NBQ201209T-060Y-S	6	0.07	800
NBQ201209T-110Y-S	11	0.10	700
NBQ201209T-260Y-S	26	0.20	600
NBQ201209T-320Y-S	32	0.20	600
NBQ201209T-600Y-S	60	0.30	500
NBQ201209T-750Y-S	75	0.30	500
NBQ201209T-900Y-S	90	0.30	500
NBQ201209T-121Y-S	120	0.40	400
NBQ201209T-151Y-S	150	0.40	400
NBQ201209T-171Y-S	170	0.50	400
NBQ201209T-221Y-S	220	0.50	300
NBQ201209T-301Y-S	300	0.50	300
NBQ201209T-401Y-S	400	0.50	300
NBQ201209T-501Y-S	500	0.50	200
NBQ201209T-601Y-S	600	0.50	200
NBQ201209T-102Y-S	1000	0.60	100
NBQ201209T-122Y-S	1200	0.70	100
NBQ201209T-152Y-S	1500	0.70	100
NBQ201209T-222Y-S	2200	0.75	100
NBQ201209T-272Y-S	2700	0.85	100
NBQ321611T-320Y-S	32	0.20	600
NBQ321611T-600Y-S	60	0.30	500
NBQ321611T-800Y-S	80	0.30	500
NBQ321611T-900Y-S	90	0.30	500
NBQ321611T-121Y-S	120	0.40	400
NBQ321611T-151Y-S	150	0.40	400
NBQ321611T-201Y-S	200	0.50	300
NBQ321611T-221Y-S	220	0.50	300
NBQ321611T-351Y-S	350	0.60	300
NBQ321611T-401Y-S	400	0.60	300
NBQ321611T-601Y-S	600	0.80	300
NBQ321611T-122Y-S	1200	1.00	200
NBQ321611T-152Y-S	1500	1.20	150



GB SERIES, FOR MID CURRENT USE

APPLICATIONS

- Computers • Modems • CD-ROMs • Hard Drives
- Televisions • Wireless Device

FEATURES

This series exhibits a low DC resistance across a wide range of impedances. Low DC resistance characteristics make the chip beads suitable for use on signal lines handling larger currents.

ELECTRICAL CHARACTERISTICS

PART NO.	IMPEDANCE at 100MHz ($\Omega \pm 25\%$)	DC RESISTANCE (Ω) Max.	RATED CURRENT (mA) Max.	PART NO.	IMPEDANCE at 100MHz ($\Omega \pm 25\%$)	DC RESISTANCE (Ω) Max.	RATED CURRENT (mA) Max.
GBK160808T-110Y-S	11	0.03	1000	GBY321611T-190Y-S	19	0.03	1000
GBK160808T-190Y-S	19	0.05	1000	GBY321611T-260Y-S	26	0.03	1000
GBK160808T-300Y-S	30	0.06	800	GBY321611T-320Y-S	32	0.03	1000
GBK160808T-400Y-S	40	0.06	800	GBY321611T-500Y-S	50	0.06	800
GBK160808T-600Y-S	60	0.06	600	GBY321611T-600Y-S	60	0.06	800
GBK160808T-800Y-S	80	0.10	600	GBK321611T-700Y-S	70	0.06	800
GBK160808T-121Y-S	120	0.15	600	GBK321611T-900Y-S	90	0.10	800
GBK160808T-221Y-S	220	0.18	400	GBK321611T-121Y-S	120	0.10	800
GBK160808T-301Y-S	300	0.25	400	GBK321611T-151Y-S	150	0.10	800
GBK160808T-451Y-S	450	0.30	400	GBK321611T-201Y-S	200	0.15	600
GBK160808T-601Y-S	600	0.30	400	GBK321611T-401Y-S	400	0.15	600
GBK160808T-751Y-S	750	0.45	300	GBK321611T-501Y-S	500	0.15	600
GBK160808T-102Y-S	1000	0.45	300	GBK321611T-601Y-S	600	0.20	500
GBY201209T-070Y-S	7	0.06	1000	GBK321611T-102Y-S	1000 *	0.25	400
GBY201209T-090Y-S	9	0.06	1000	GBK321611T-122Y-S	1200 *	0.25	400
GBY201209T-110Y-S	11	0.06	1000	GBK321611T-202Y-S	2000 **	0.35	400
GBY201209T-170Y-S	17	0.06	1000	GBY321616T-250Y-S	25	0.10	1000
GBY201209T-320Y-S	32	0.06	1000	GBY321616T-600Y-S	60	0.10	1000
GBK201209T-600Y-S	60	0.10	800	GBK321616T-700Y-S	70	0.10	1000
GBK201209T-700Y-S	70	0.10	800	GBY322513T-320Y-S	32	0.10	1000
GBK201209T-800Y-S	80	0.10	800	GBY322513T-600Y-S	60	0.10	1000
GBK201209T-121Y-S	120	0.15	600	GBY322513T-900Y-S	90	0.10	1000
GBK201209T-151Y-S	150	0.15	600	GBY451616T-500Y-S	50	0.10	1000
GBK201209T-221Y-S	220	0.18	600	GBY451616T-600Y-S	60	0.10	1000
GBK201209T-301Y-S	300	0.18	600	GBY451616T-800Y-S	80	0.10	1000
GBK201209T-401Y-S	400	0.18	600	GBY451616T-101Y-S	100	0.18	800
GBK201209T-501Y-S	500	0.25	500	GBK451616T-151Y-S	150	0.18	800
GBK201209T-601Y-S	600	0.25	500	GBK451616T-171Y-S	170	0.18	800
GBK201209T-751Y-S	750	0.30	400	GBY453215T-700Y-S	70	0.18	800
GBK201209T-102Y-S	1000	0.30	400	GBY453215T-121Y-S	120	0.18	800
GBK201209T-152Y-S	1500	0.40	300				
GBK201209T-202Y-S	2000	0.55	200				

Note : * at 50MHz ** at 30MHz



TAPE DIMENSIONS

Dimensions : mm

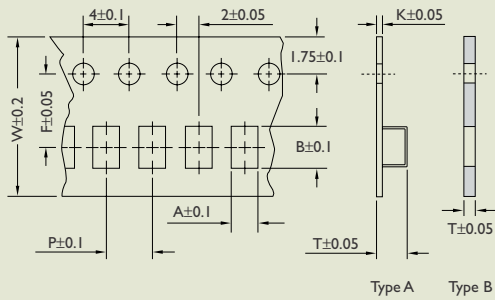

TYPE		A	B	T	W	P	F	K	TAPE TYPE
SB/PB/NB	100505	0.62	1.15	0.70	8.0	2.0	3.5	—	B
SB/PB/UP/NB/GB	160808	1.05	1.80	0.95	8.0	4.0	3.5	—	B
SB/PB/UP/NB/GB	201209	1.42	2.30	1.05	8.0	4.0	3.5	0.2	A
SB/PB/UP/NB/GB	321611	1.88	3.50	1.27	8.0	4.0	3.5	0.2	A
SB/GB	321616	1.88	3.64	1.90	8.0	4.0	3.5	0.2	A
SB/GB	322513	2.77	3.42	1.65	8.0	4.0	3.5	0.2	A
SB/PB/GB	451616	1.88	4.95	1.90	12.0	4.0	5.5	0.3	A
SB/PB/GB	453215	3.66	4.95	1.85	12.0	8.0	5.5	0.3	A

TAPE MATERIAL

Carrier Tape : Polystyrene (for 201209, 201211, 321611, etc.)

Paper (for 160808, 100505)

Cover Tape : Polyethylene

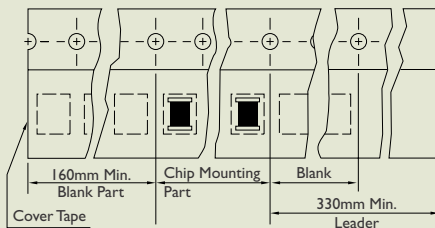

PACKAGING QUANTITY

TYPE		BULK	QUANTITY/REEL
SB/PB/NB	100505	√	10000
SB/PB/UP/NB/GB	160808	√	4000
SB/PB/UP/NB/GB	201209	√	4000
SB/PB/UP/NB/GB	321611	√	3000
SB/GB	321616	√	2000
SB/GB	322513	√	2500
SB/PB/GB	451616	√	2000
SB/PB/GB	453215	√	1000

REEL DIMENSIONS

Dimensions : mm

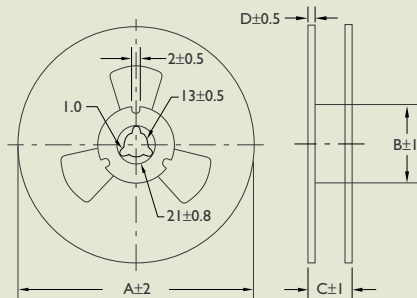

TYPE		A	B	C	D
SB/PB/NB	100505	178	60	10	2
SB/PB/UP/NB/GB	160808	178	60	10	2
SB/PB/UP/NB/GB	201209	178	60	10	2
SB/PB/UP/NB/GB	321611	178	60	10	2
SB/GB	321616	178	60	10	2
SB/GB	322513	178	60	10	2
SB/PB/GB	451616	178	60	14	2
SB/PB/GB	453215	178	60	14	2

RECOMMENDED PATTERN

Dimensions : mm

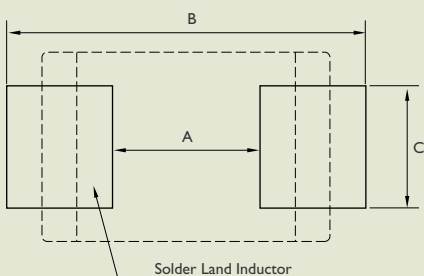

TYPE		A	B	C
SB/PB/NB	100505	0.4	1.2 ~ 1.4	0.4
SB/PB/UP/NB/GB	160808	0.8	2.4 ~ 3.4	0.6
SB/PB/UP/NB/GB	201209	1.2	3.0 ~ 4.0	1.0
SB/PB/UP/NB/GB	321611	2.0	4.2 ~ 5.2	1.2
SB/GB	321616	2.0	4.2 ~ 5.2	1.2
SB/GB	322513	2.0	5.5 ~ 6.5	1.8
SB/PB/GB	451616	3.0	5.5 ~ 6.5	1.2
SB/PB/GB	453215	3.0	5.5 ~ 6.5	2.4

* Don't apply narrower pattern than listed above to PB. Narrow pattern might cause excessive heat or open circuit.



TYPICAL ELECTRICAL CHARACTERISTICS

Test Instruments : HP4291A Impedance / Material Analyzer

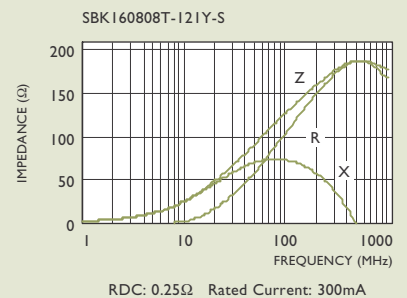
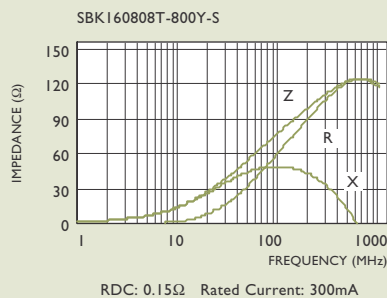
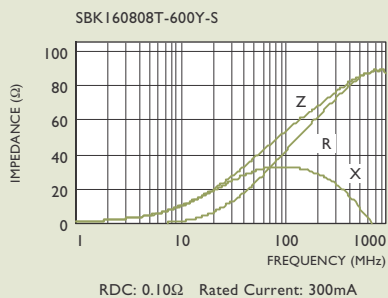
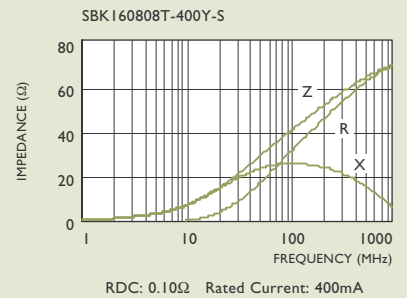
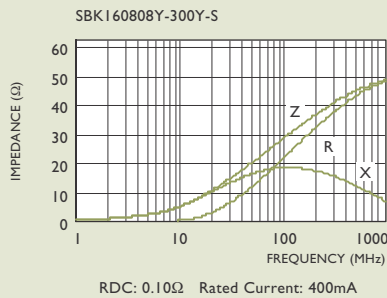
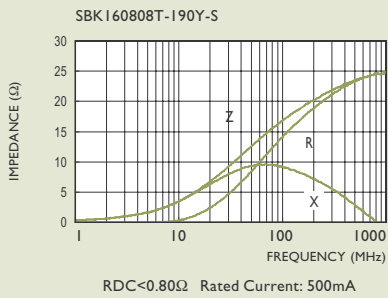
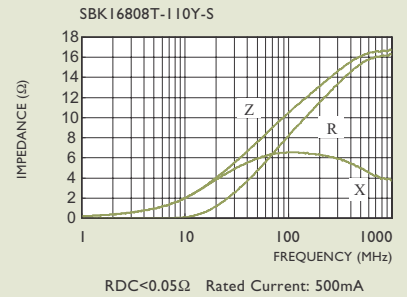
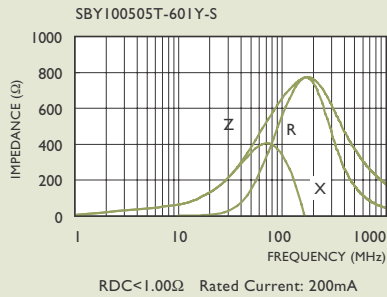
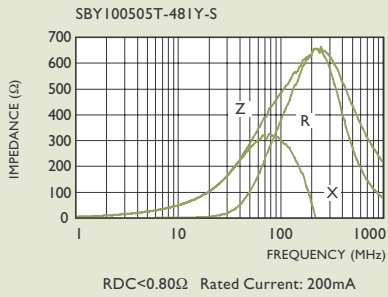
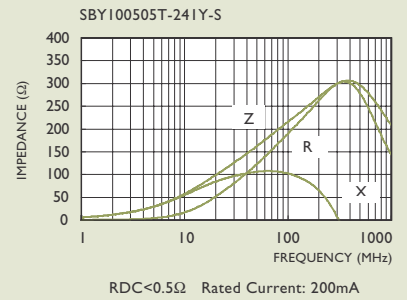
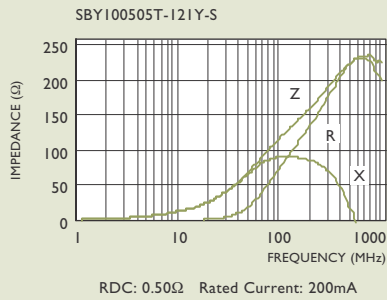
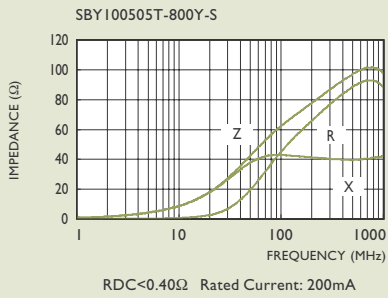
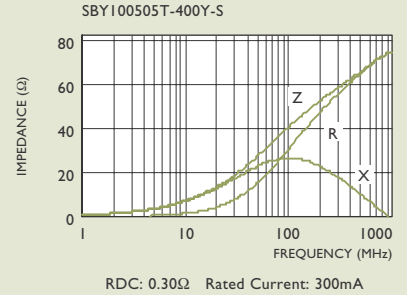
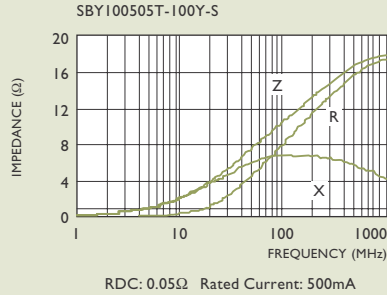
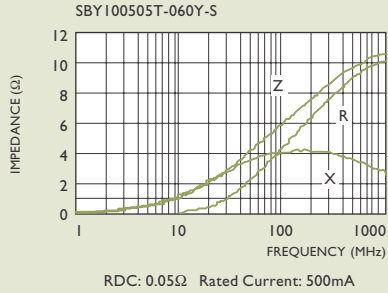



TYPICAL ELECTRICAL CHARACTERISTICS

Test Instruments : HP4291A Impedance / Material Analyzer

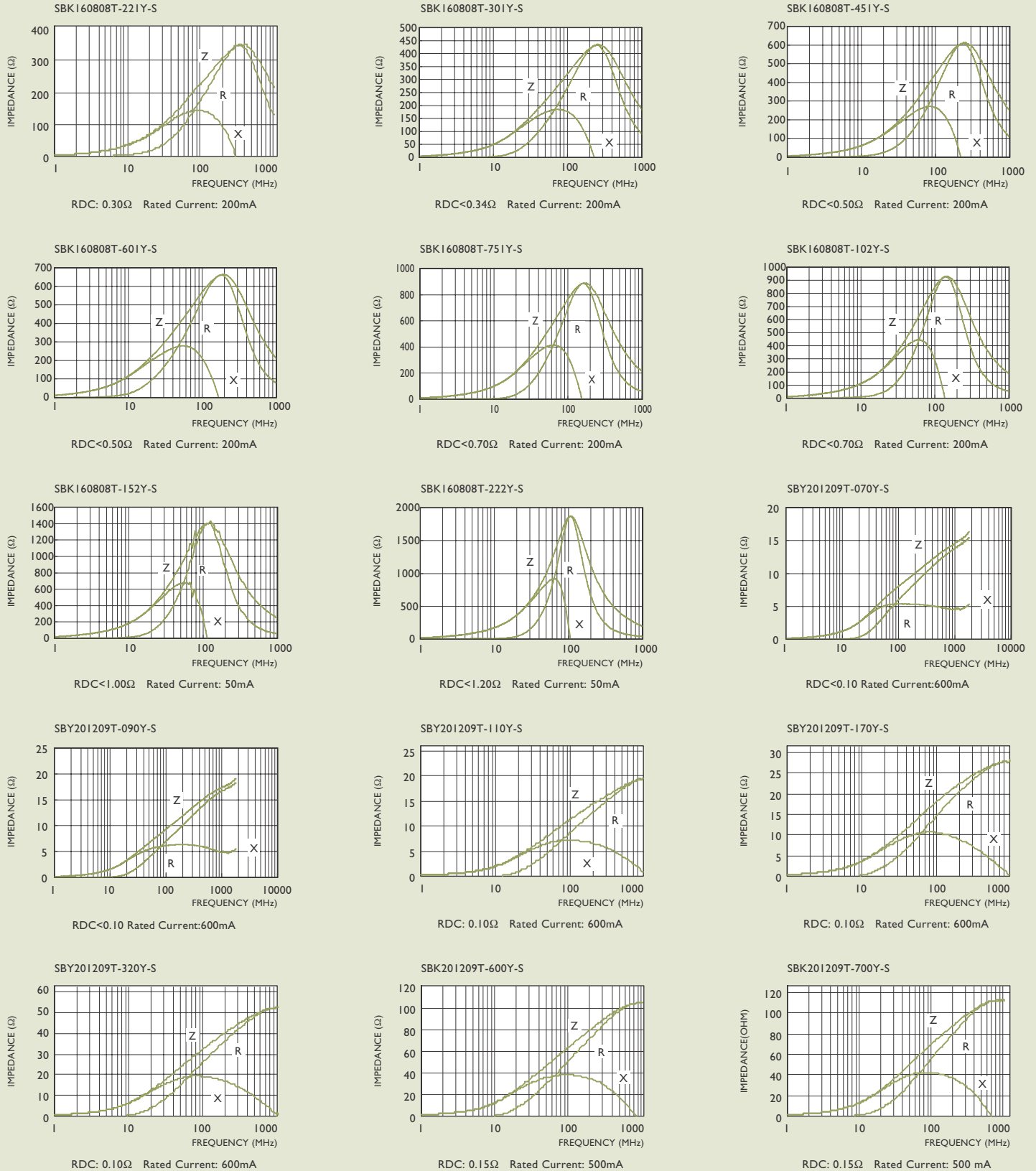



TYPICAL ELECTRICAL CHARACTERISTICS

Test Instruments : HP4291A Impedance / Material Analyzer

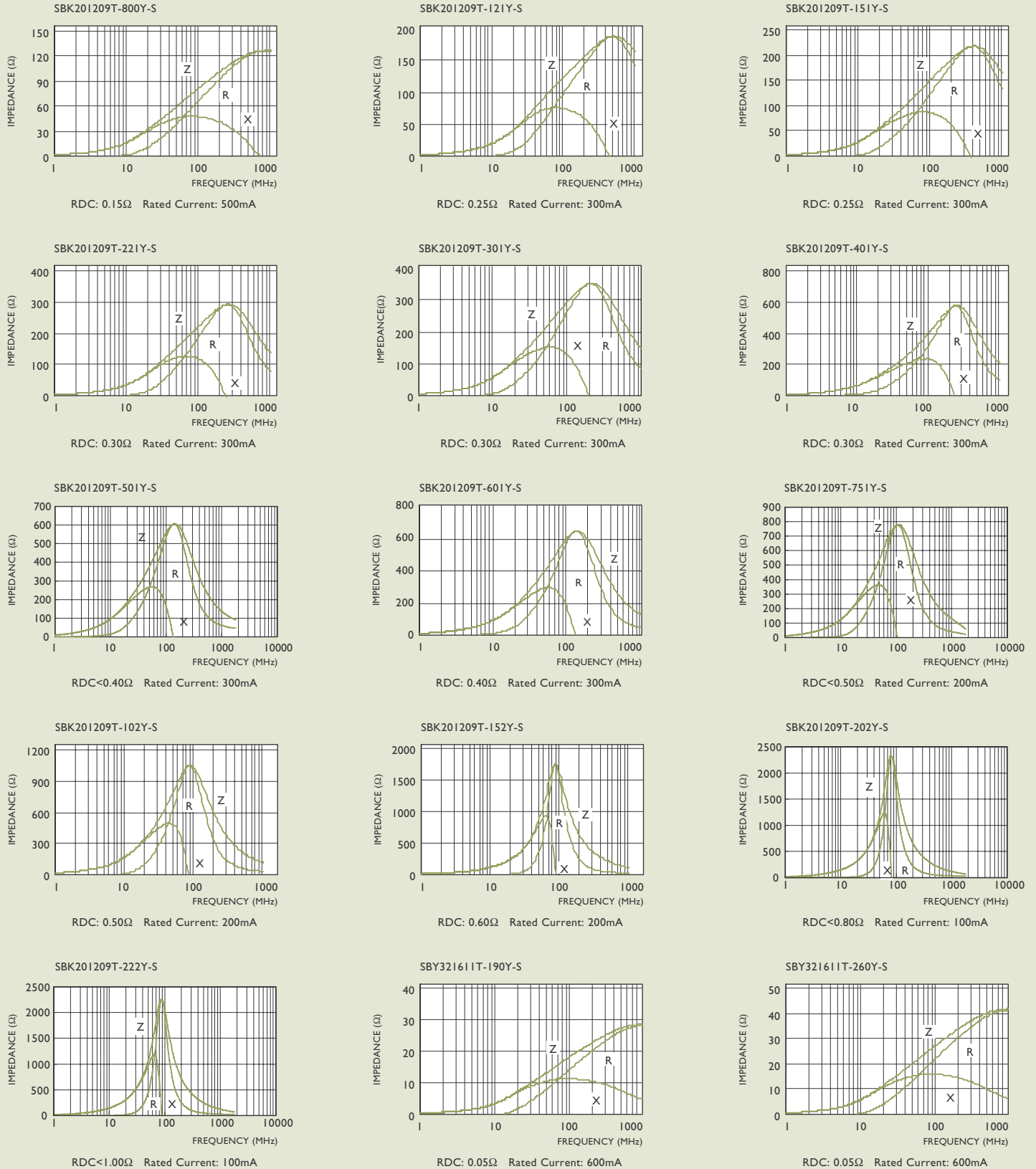



TYPICAL ELECTRICAL CHARACTERISTICS

Test Instruments : HP4291A Impedance / Material Analyzer

SBY321611T-320Y-S

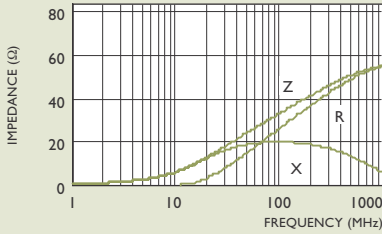

RDC: 0.05Ω Rated Current: 600mA

SBY321611T-500Y-S

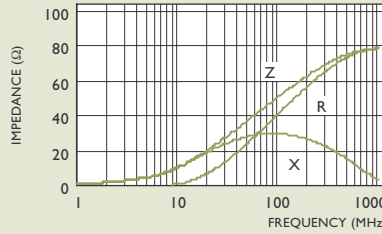

RDC: 0.10Ω Rated Current: 500mA

SBY321611T-600Y-S

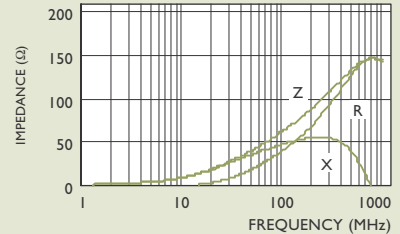

RDC: 0.10Ω Rated Current: 500mA

SBK321611T-700Y-S

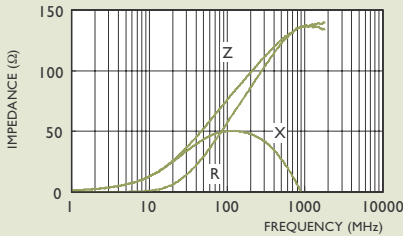

RDC<0.20Ω Rated Current: 500mA

SBK321611T-900Y-S

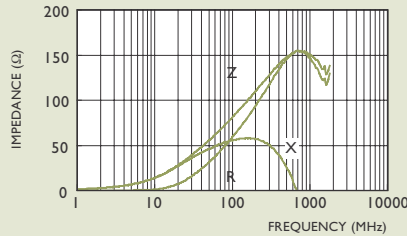

RDC<0.20Ω Rated Current: 500mA

SBK321611T-121Y-S

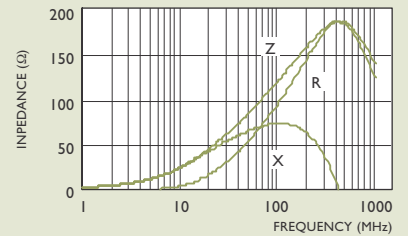

RDC: 0.15Ω Rated Current: 500mA

SBK321611T-151Y-S

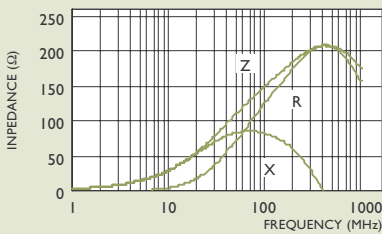

RDC: 0.15Ω Rated Current: 500mA

SBK321611T-201Y-S

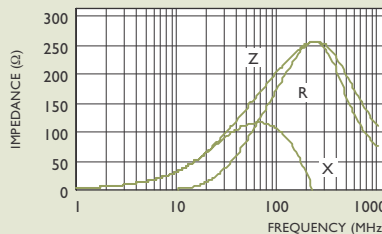

RDC: 0.20Ω Rated Current: 400mA

SBK321611T-401Y-S

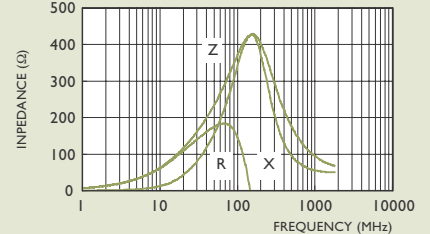

RDC<0.20Ω Rated Current: 400mA

SBK321611T-501Y-S

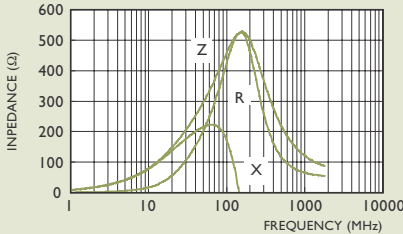

RDC<0.20Ω Rated Current: 400mA

SBK321611T-601Y-S

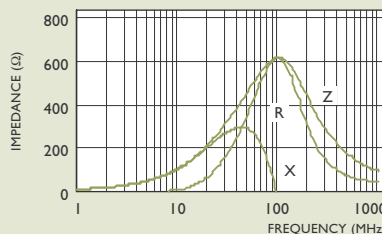

RDC: 0.30Ω Rated Current: 400mA

SBK321611T-102Y-S

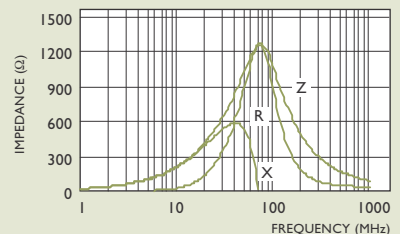

RDC: 0.40Ω Rated Current: 200mA

SBK321611T-122Y-S

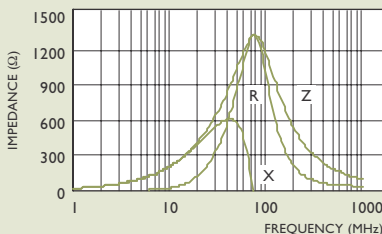

RDC: 0.40Ω Rated Current: 200mA

SBK321611T-152Y-S

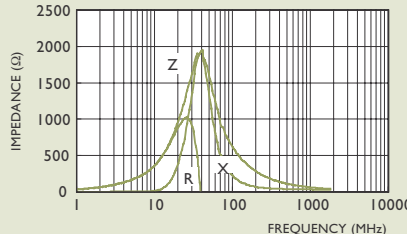

RDC<0.45Ω Rated Current: 200mA

SBK321611T-202Y-S

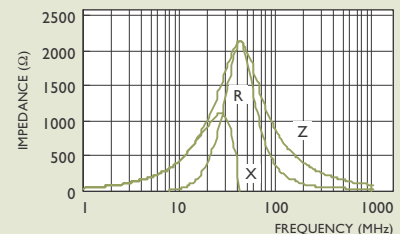

RDC: 0.60Ω Rated Current: 200mA



TYPICAL ELECTRICAL CHARACTERISTICS

Test Instruments : HP4291A Impedance / Material Analyzer

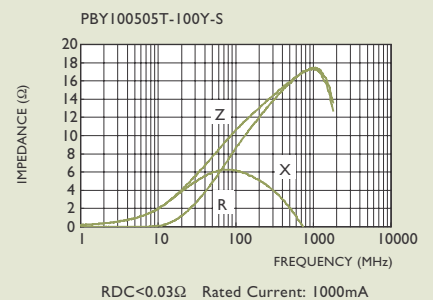
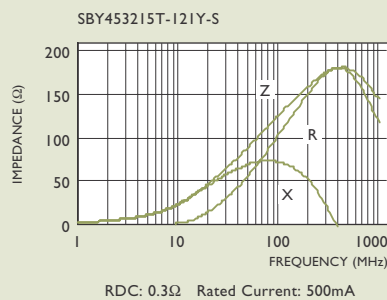
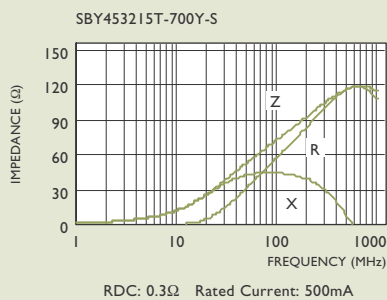
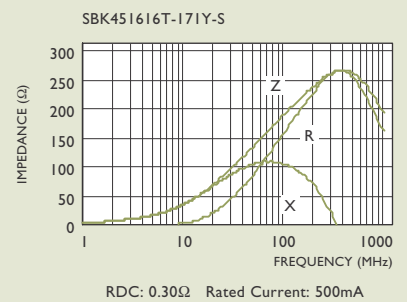
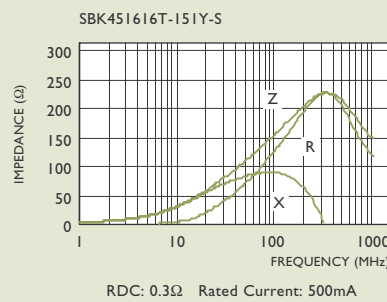
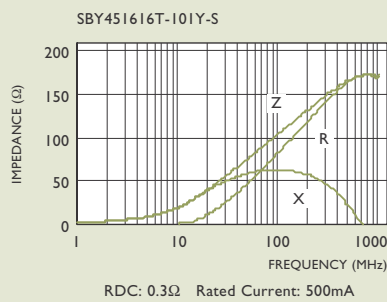
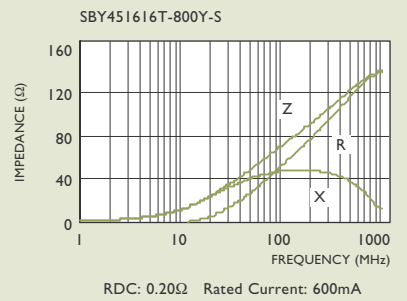
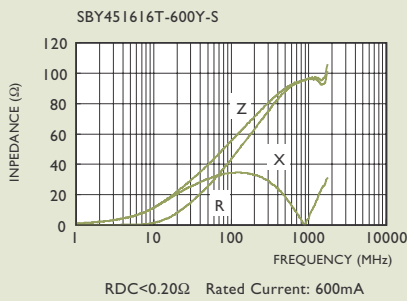
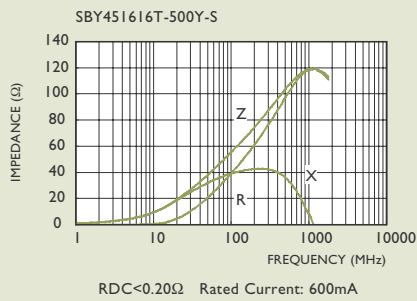
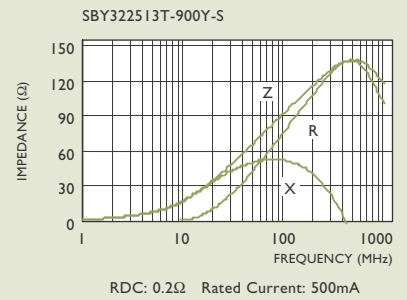
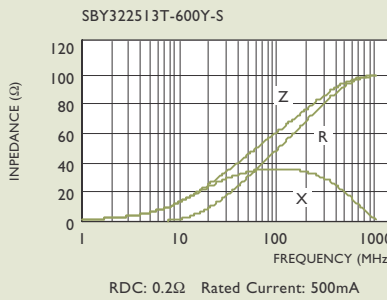
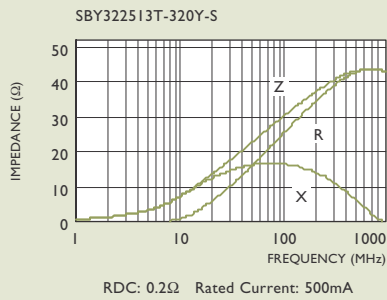
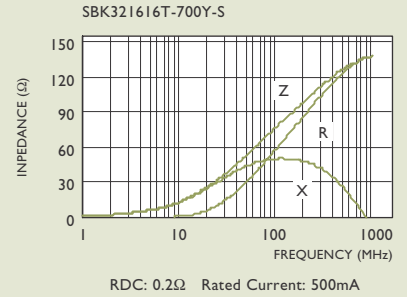
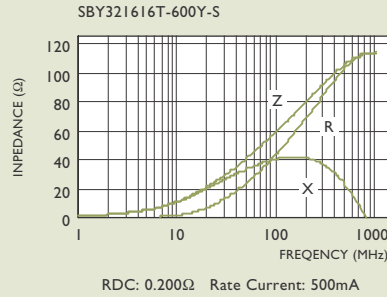
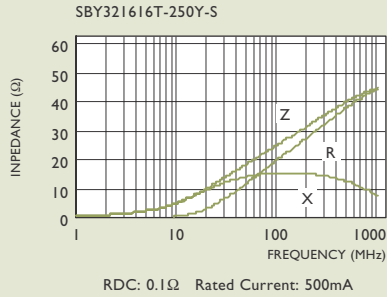



TYPICAL ELECTRICAL CHARACTERISTICS

Test Instruments : HP4291A Impedance / Material Analyzer

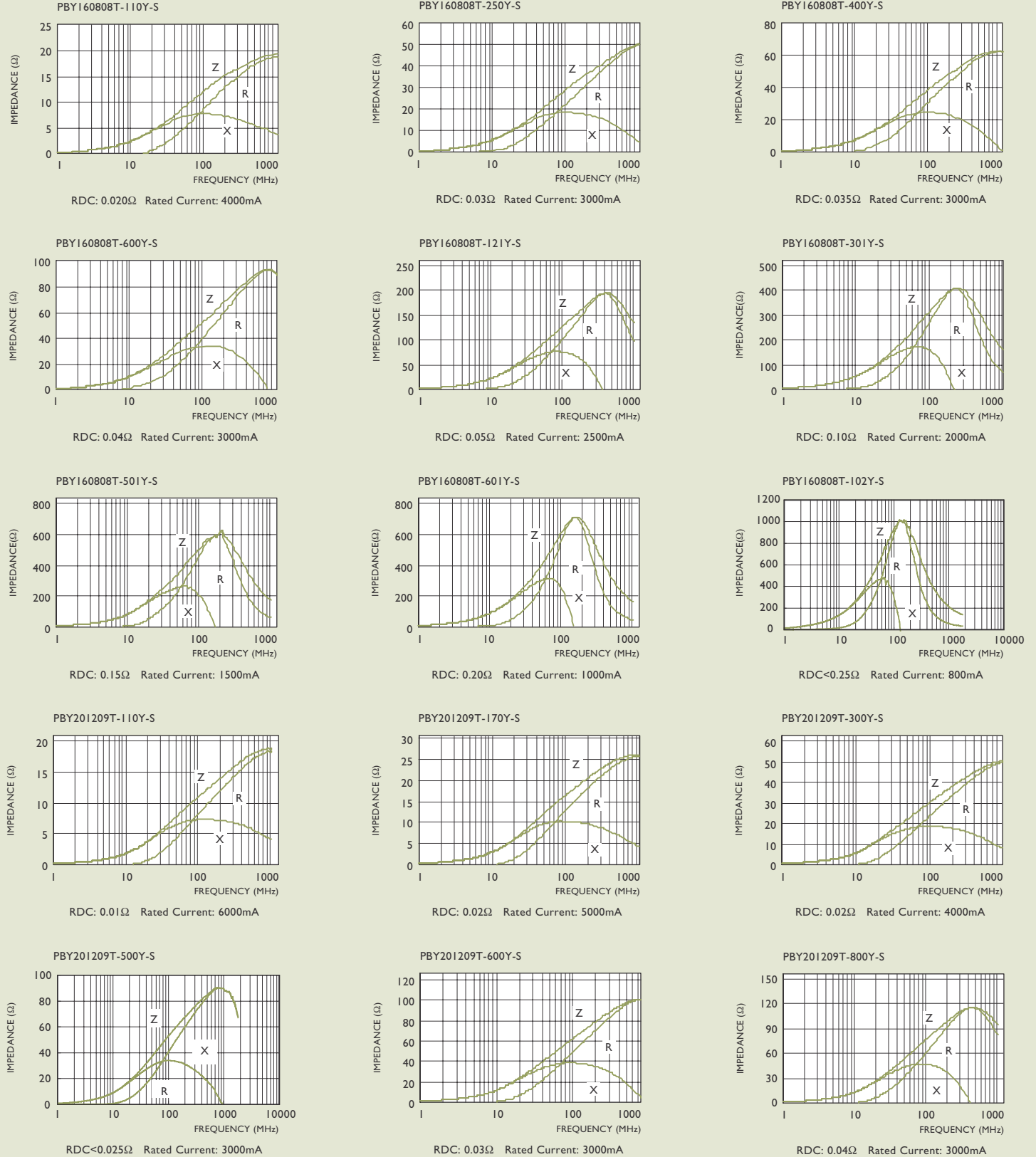



TYPICAL ELECTRICAL CHARACTERISTICS

Test Instruments : HP4291A Impedance / Material Analyzer

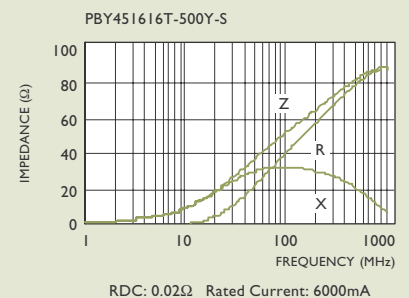
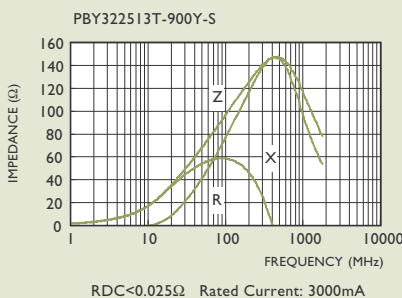
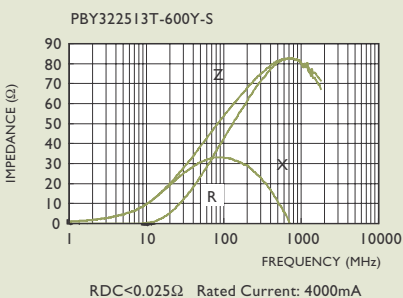
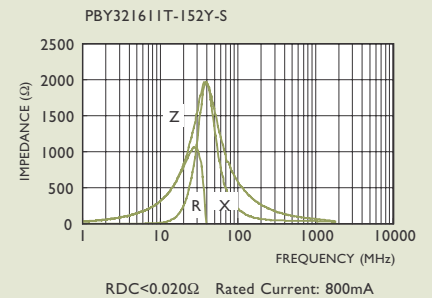
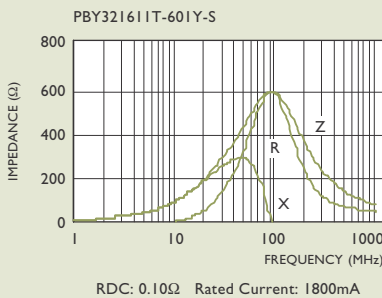
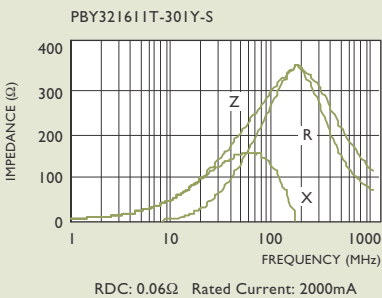
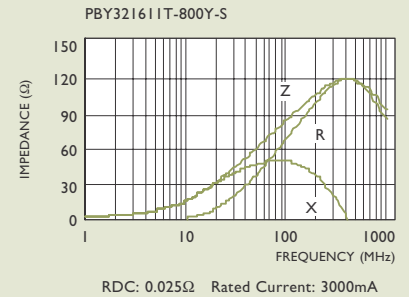
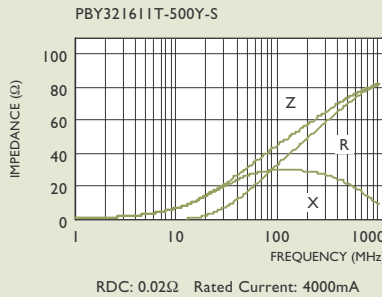
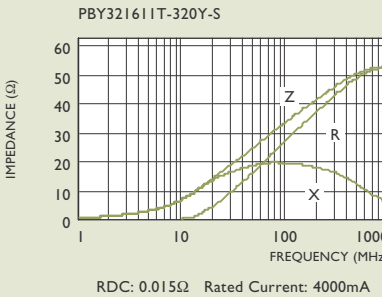
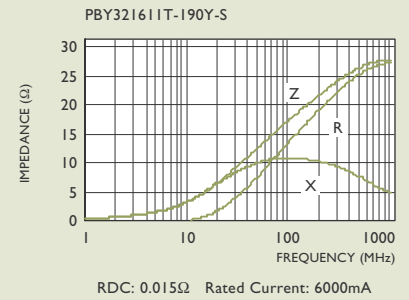
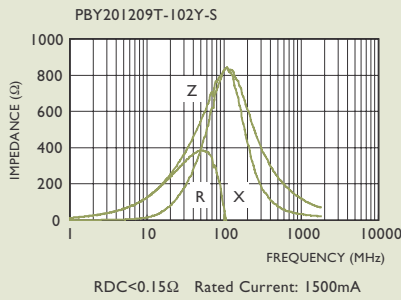
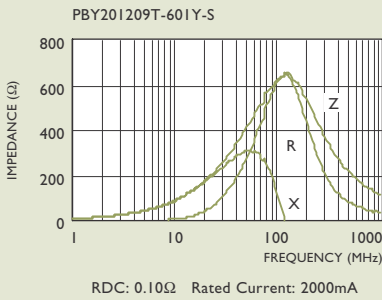
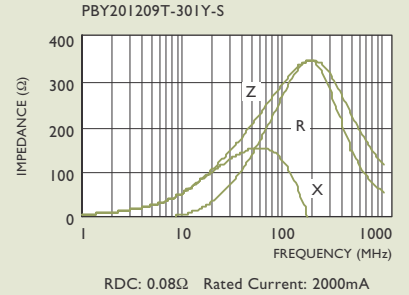
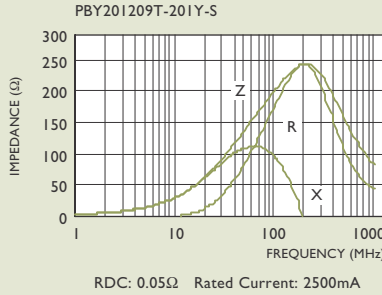
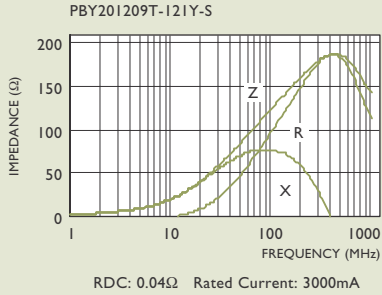



TYPICAL ELECTRICAL CHARACTERISTICS

Test Instruments : HP4291A Impedance / Material Analyzer

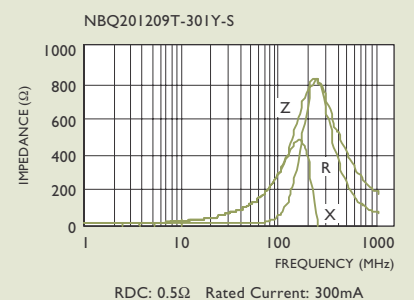
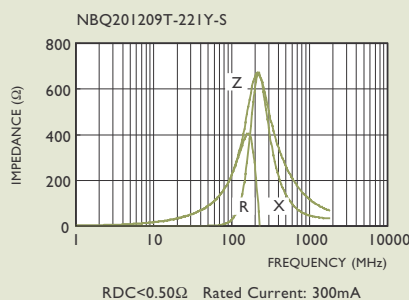
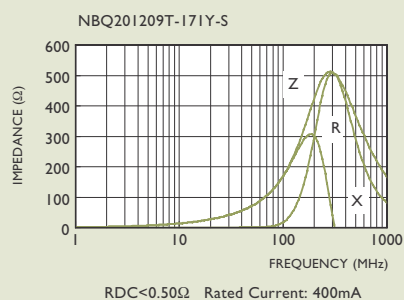
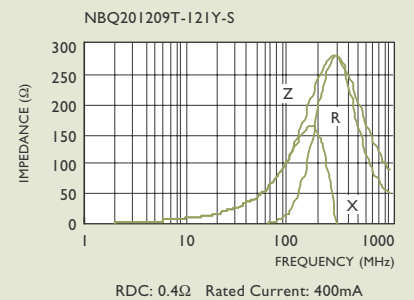
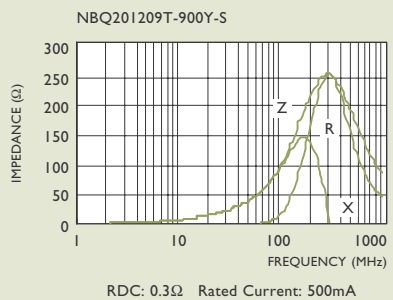
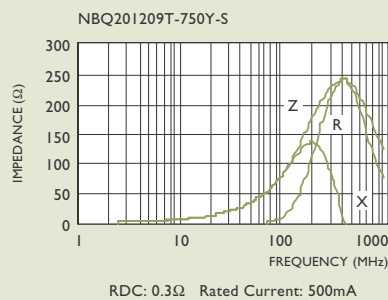
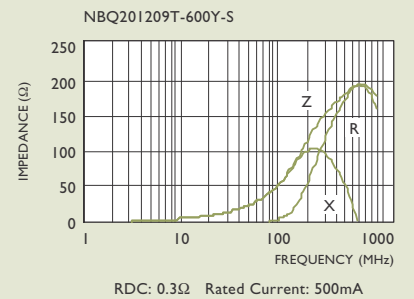
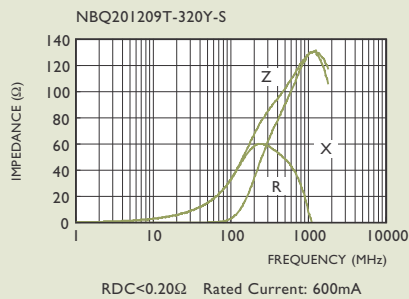
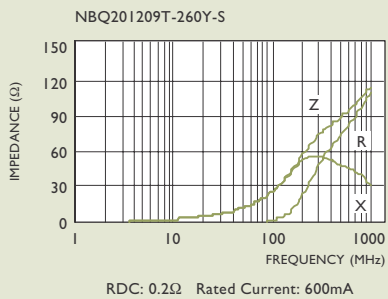
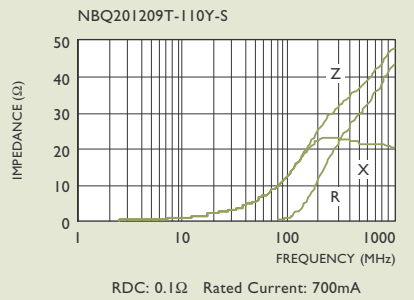
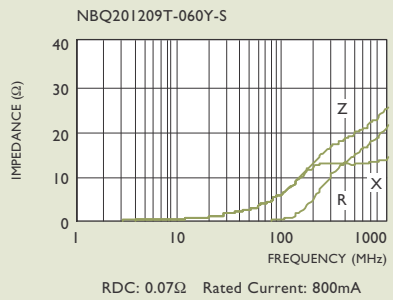
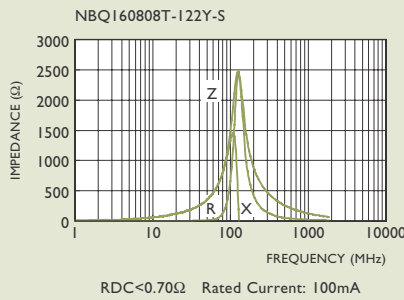
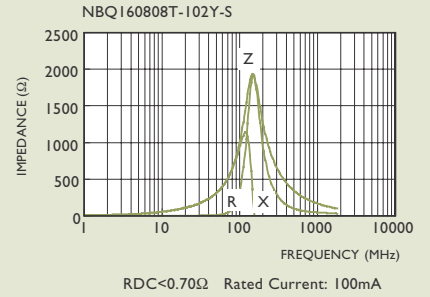
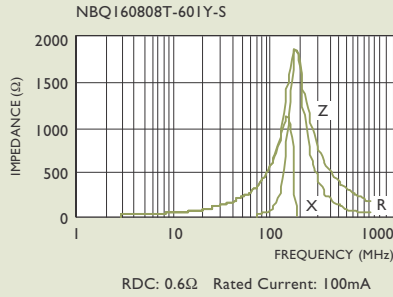
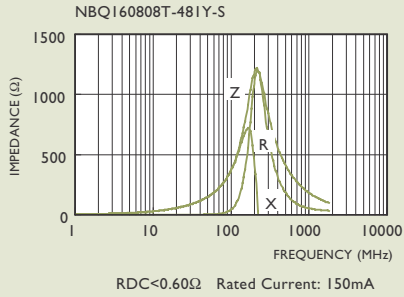



TYPICAL ELECTRICAL CHARACTERISTICS

Test Instruments : HP4291A Impedance / Material Analyzer

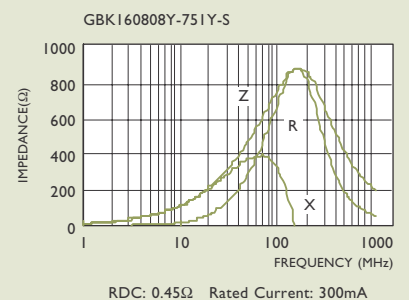
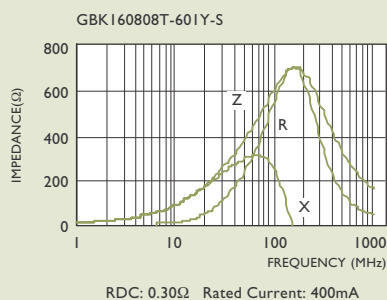
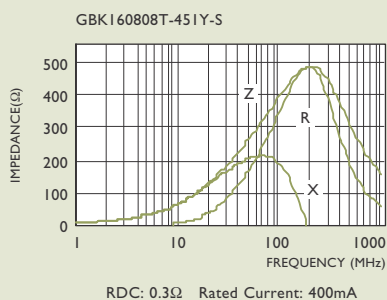
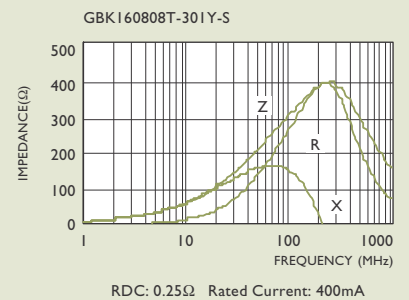
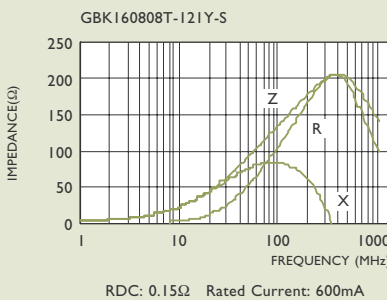
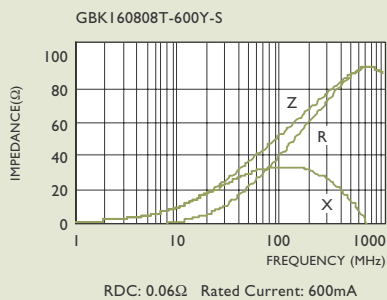
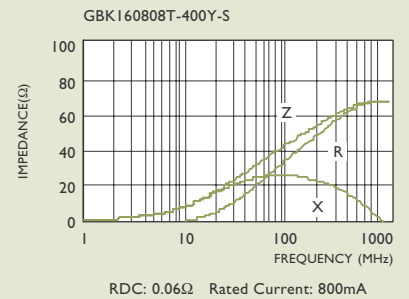
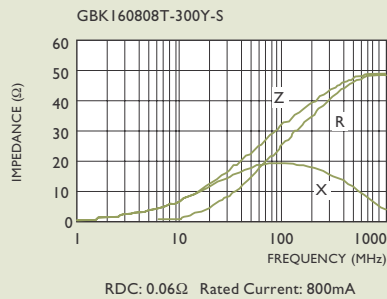
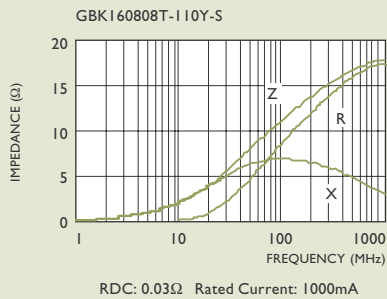
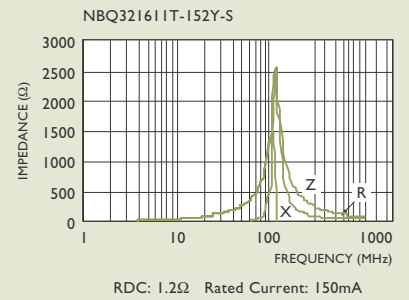
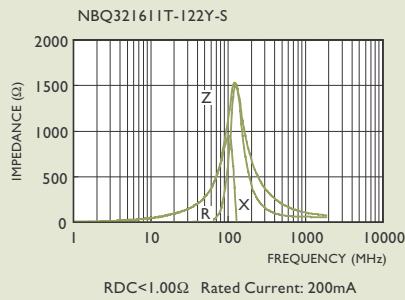
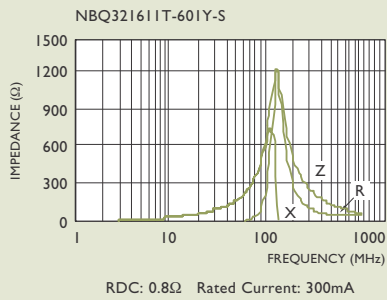
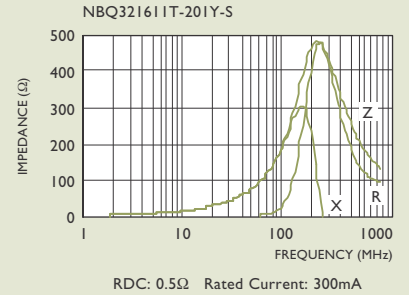
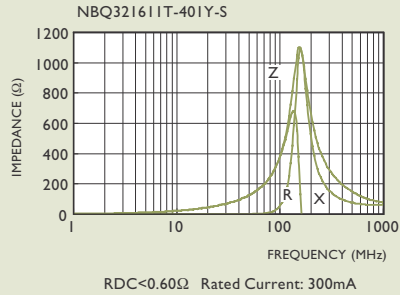
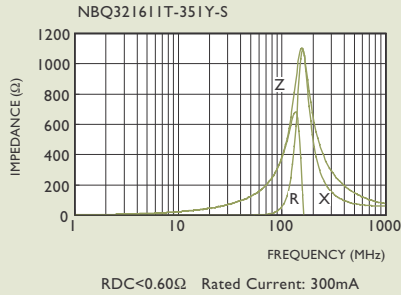



TYPICAL ELECTRICAL CHARACTERISTICS

Test Instruments : HP4291A Impedance / Material Analyzer

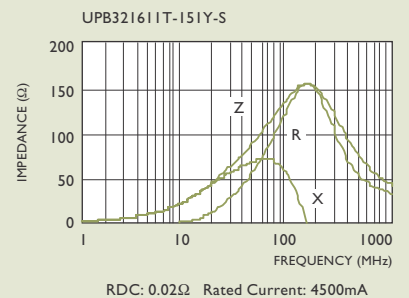
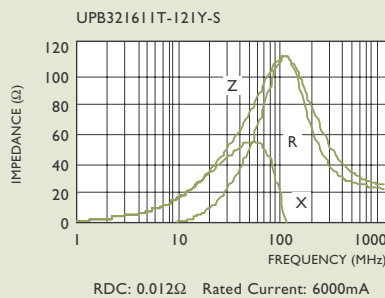
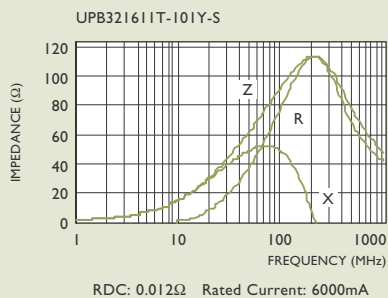
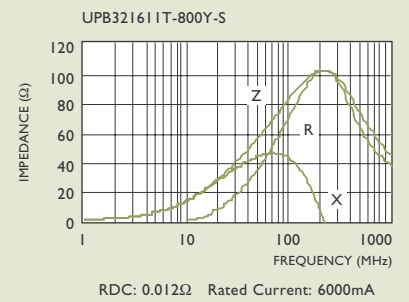
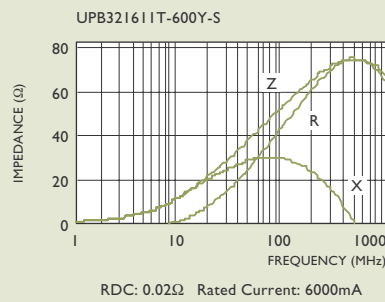
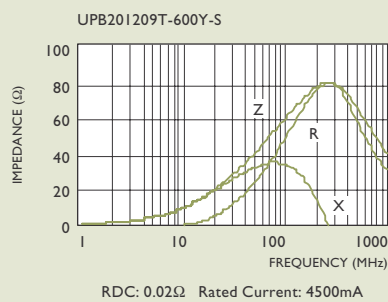
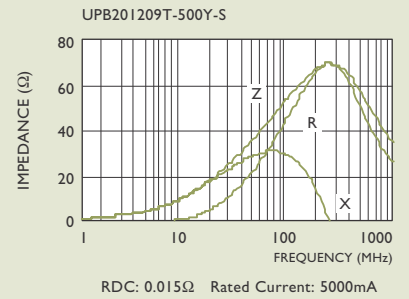
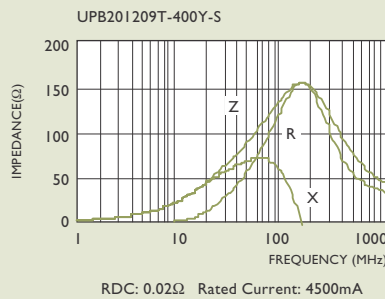
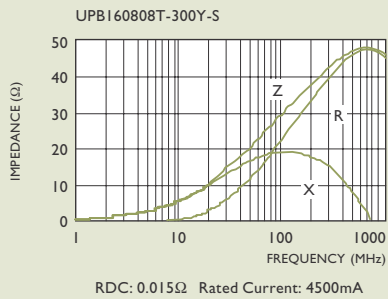
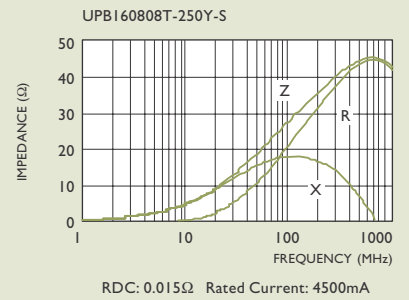
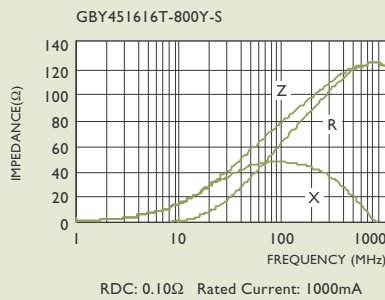
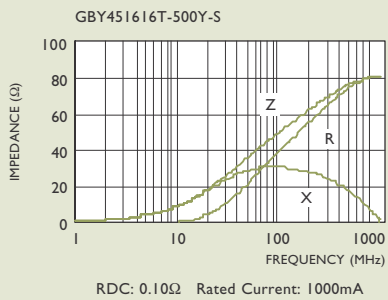
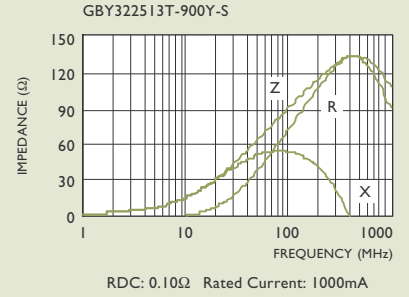
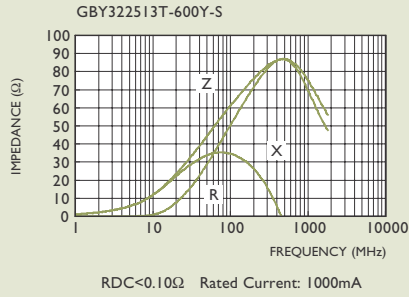
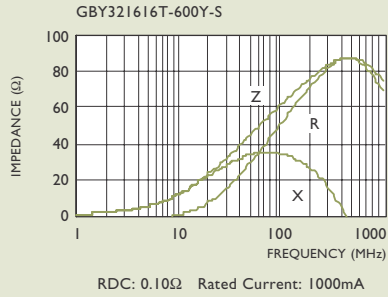



Multilayer Ferrite Chip Beads

BA Series

[For Higher Density Circuit Design]

APPLICATIONS

- Computers • LCD Monitor • Hard Disk Drives • CD-ROMs • Motherboard

FEATURES

These multi-layered chip bead arrays are surface mounting EMI components.

For suppressing noise of four line in one chip.

It suited for higher density circuit design.

ELECTRICAL CHARACTERISTICS

PART NO.	IMPEDANCE at 100MHz ($\Omega \pm 25\%$)	DC RESISTANCE (Ω) Max.	RATED CURRENT (mA) Max.
BAY321609T-300Y-S	30	0.4	350
BAY321609T-600Y-S	60	0.4	250
BAY321609T-121Y-S	120	0.8	150
BAY321609T-241Y-S	240	0.8	150
BAY321609T-301Y-S	300	0.8	150
BAY321609T-471Y-S	470	1	100
BAY321609T-601Y-S	600	1.5	100
BAY321609T-102Y-S	1000	1.7	50
BAQ321609T-600Y-S	60	0.8	150
BAQ321609T-121Y-S	120	0.8	150
BAQ321609T-221Y-S	220	0.8	150
BAQ321609T-471Y-S	470	1	150
BAQ321609T-601Y-S	600	1.5	100
BAQ321609T-102Y-S	1000	1.8	100

SHAPES AND DIMENSIONS

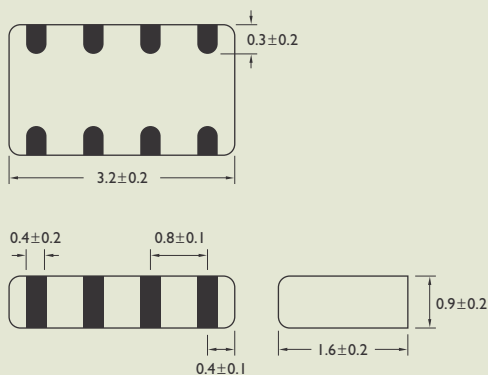

PRODUCT IDENTIFICATION

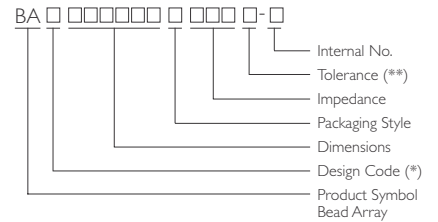

*Y = General Purpose; Q = Narrow Band
 **Y = $\pm 25\%$

Parts Dimensions : 3.20 x 1.60 x 0.90 mm

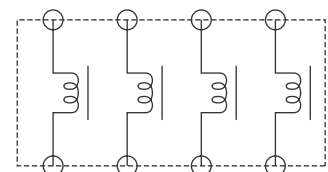



TAPE DIMENSIONS

Dimensions : mm

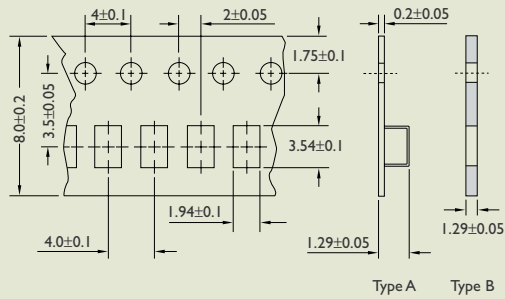

TAPE MATERIAL

Carrier Tape : Polystyrene for 321609

Cover Type : Polyethyene

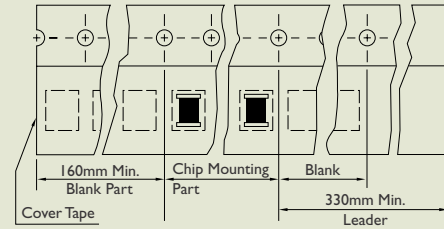

REEL DIMENSIONS

Dimensions : mm

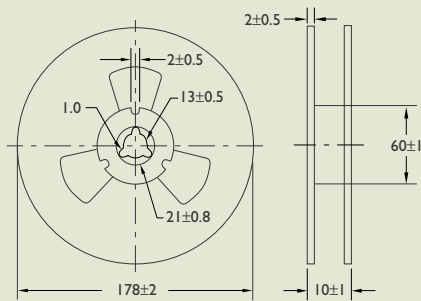

RECOMMENDED PATTERN

Dimensions : mm

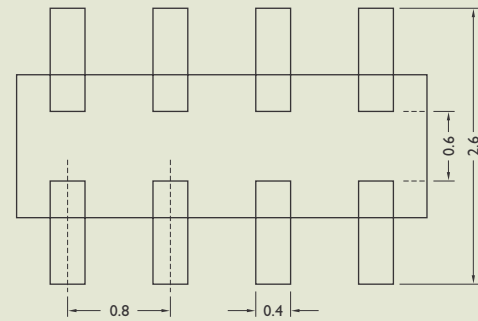

PACKAGING QUANTITY

TYPE	QUANTITY/REEL
BAY321609	3000
BAQ321609	3000

TYPICAL ELECTRICAL CHARACTERISTICS

Test Instruments : HP4291A Impedance / Material Analyzer

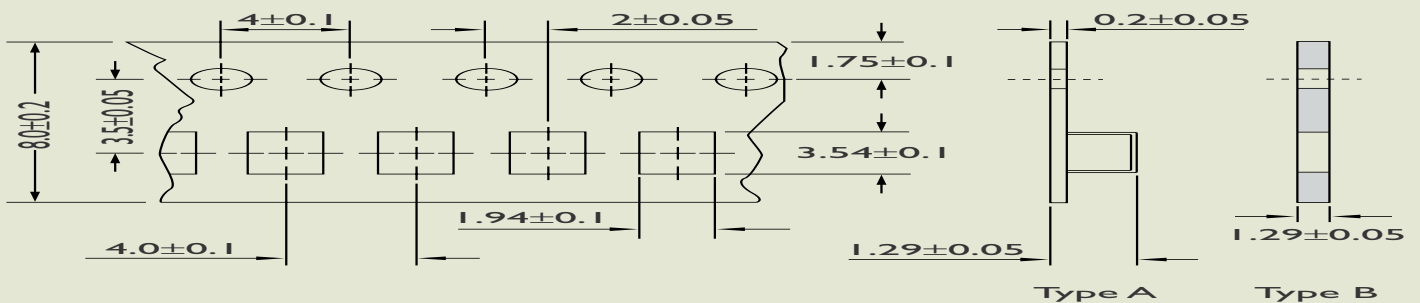



SB/PB/UP/NB/GB/BA SERIES RELIABILITY TEST

I-1 MECHANICAL PERFORMANCE

NO.	ITEM	SPECIFICATION	TEST CONDITIONS
I-1-1	Flexure Strength	Appearance : No Damage Z Change : within $\pm 20\%$ RDC : within Specification	Test device shall be soldered on the substrate. Substrate Dimension : 100 x 40 x 1.6mm Deflection : 2.0mm Keeping Time : 30Sec. * For 100505, substrate dimension is 100 x 40 x 0.8mm.
I-1-2	Vibration		Test device shall be soldered on the substrate. Oscillation Frequency : 10 to 55 to 10Hz for 1Min. Amplitude : 1.5mm Time : 2Hrs. for each Axis (X, Y & Z), Total 6Hrs.
I-1-3	Resistance to Soldering Heat	Appearance : No Damage	Pre-heating : 150°C, 1Min. Solder Composition : Sn/Pb = 63/37 Solder Temperature : 260 \pm 5°C Immersion Time : 10 \pm 1Sec.
I-1-4	Solderability	The electrodes shall be at least 90% covered with new solder coating.	Pre-heating : 150°C, 1Min. Solder Composition : Sn/Pb = 63/37 Solder Temperature : 230 \pm 5°C Immersion Time : 4 \pm 1Sec.
I-1-5	Terminal Strength Test	100505 Series : \geq 0.2kg 160808 Series : \geq 0.5kg 201209 Series : \geq 1.0kg Other Series : \geq 2.0kg	Test device shall be soldered on the substrate.

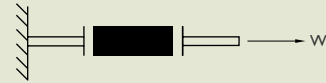
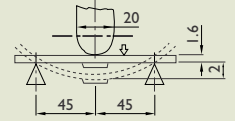

I-2 ENVIRONMENTAL PERFORMANCE

NO.	ITEM	SPECIFICATION	TEST CONDITIONS															
I-2-1	Temperature Cycle	Appearance : No Damage Z Change : within $\pm 20\%$ RDC : within Specification	One Cycle <table border="1"> <thead> <tr> <th>Step</th> <th>Temperature (°C)</th> <th>Time (Min.)</th> </tr> </thead> <tbody> <tr> <td>1</td> <td>-55 \pm 3</td> <td>30</td> </tr> <tr> <td>2</td> <td>25 \pm 2</td> <td>3</td> </tr> <tr> <td>3</td> <td>125 \pm 3</td> <td>30</td> </tr> <tr> <td>4</td> <td>25 \pm 2</td> <td>3</td> </tr> </tbody> </table> Total : 100 Cycles Measured after Exposure in the Room Condition for 24Hrs.	Step	Temperature (°C)	Time (Min.)	1	-55 \pm 3	30	2	25 \pm 2	3	3	125 \pm 3	30	4	25 \pm 2	3
Step	Temperature (°C)	Time (Min.)																
1	-55 \pm 3	30																
2	25 \pm 2	3																
3	125 \pm 3	30																
4	25 \pm 2	3																
I-2-2	Humidity Resistance		Temperature : 40 \pm 2°C Relative Humidity : 90 ~ 95% Time : 1000Hrs. Measured after Exposure in the Room Condition for 24Hrs.															
I-2-3	High Temperature Resistance		Temperature : 125 \pm 3°C Relative Humidity : 0% Applied Current : Rated Current Time : 1000Hrs. Measured after Exposure in the Room Condition for 24Hrs.															
I-2-4	Low Temperature Resistance		Temperature : -55 \pm 3°C Relative Humidity : 0% Time : 1000Hrs. Measured after Exposure in the Room Condition for 24Hrs.															



Multilayer Ferrite Bead Array - BA Series

Test Instruments : HP4291A Impedance / Material Analyzer

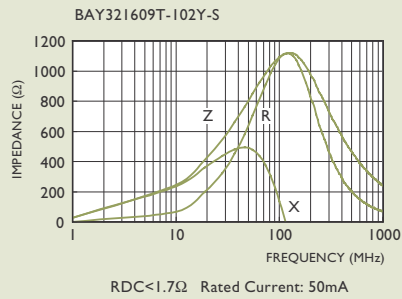
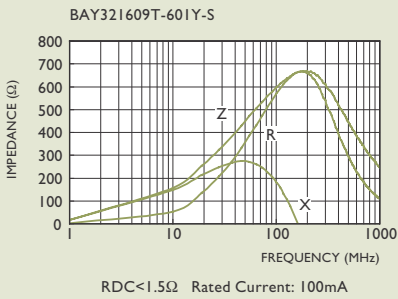
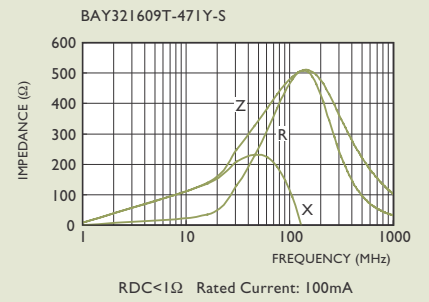
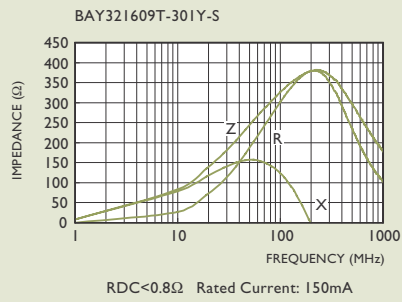
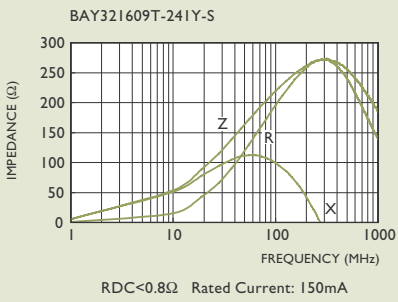
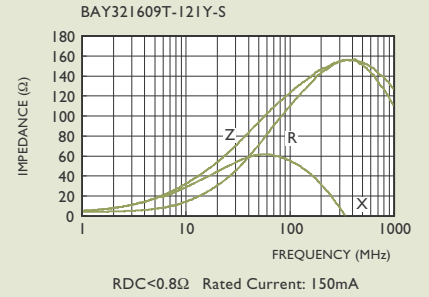
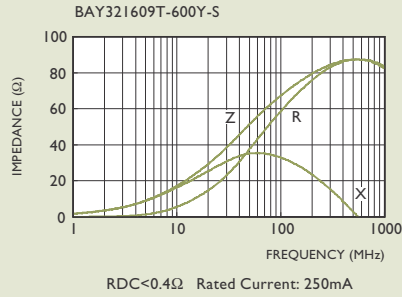
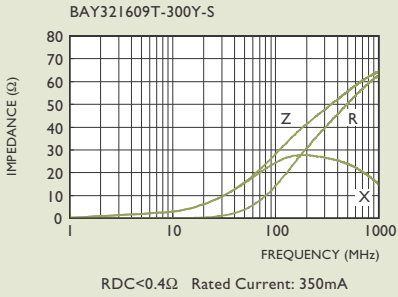



ELECTRICAL CHARACTERISTICS

PART NO.	IMPEDANCE (Ω) Min. at 25MHz	IMPEDANCE (Ω) Min. at 100MHz	DC RESISTANCE (Ω) Max.
FB423226-Y7-S	24	36	0.6
FB784729-Y7-S	48	72	0.9
FB863226-Y7-S	48	72	0.9
FB865626-Y7-S	30	60 \pm 20%	

TAPE DIMENSIONS

Dimensions : mm

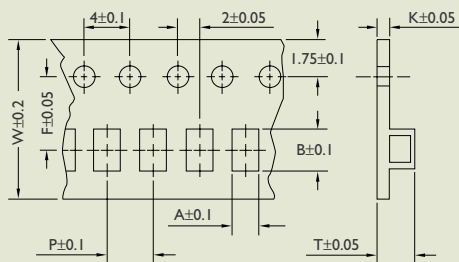

TYPE	A	B	T	W	P	F	K
FB423226-S	3.64	5.30	3.10	12	8	5.5	0.3
FB784729-S	5.24	8.77	3.69	16	8	8.0	0.3
FB863226-S	3.28	9.35	3.06	16	8	7.5	0.3
FB865626-S	6.30	9.30	3.10	16	8	7.5	0.27

TAPE MATERIAL

Carrier Tape : Polystyrene Cover Type : Polyethyiene

PACKAGING QUANTITY

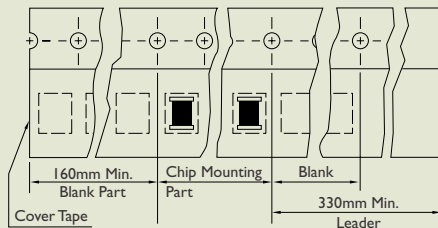

TYPE	BULK	QUANTITY/REEL
FB423226-Y7	√	500
FB784729-Y7	√	500
FB863226-Y7	√	500
FB865626-Y7	√	2400



REEL DIMENSIONS

Dimensions : mm

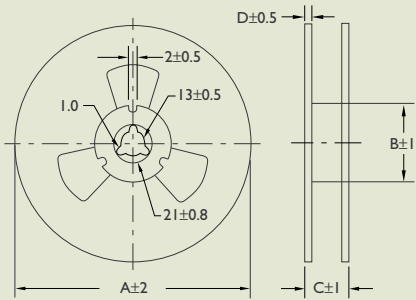

TYPE	A	B	C	D
FB423226	178	60	16	1.5
FB784729	178	60	20	1.5
FB863226	178	60	20	1.5
FB865626	330	100	21	2

RECOMMENDED PATTERN

Dimensions : mm

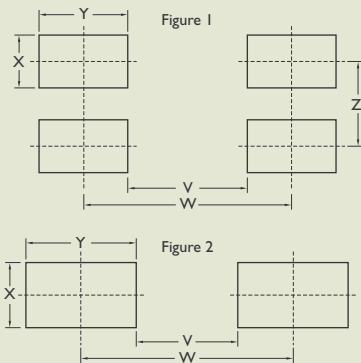

TYPE	V	W	X	Y	Z	FIGURE
FB423226	1.0	4.0	1.8	3.0	–	2
FB784729	5.0	8.0	1.8	3.0	–	2
FB863226	4.5	7.5	1.8	3.0	–	2
FB865626	4.5	7.5	1.8	3.0	2.54	1

TYPICAL ELECTRICAL CHARACTERISTICS

Test Instruments : HP4291A Impedance/Material Analyzer

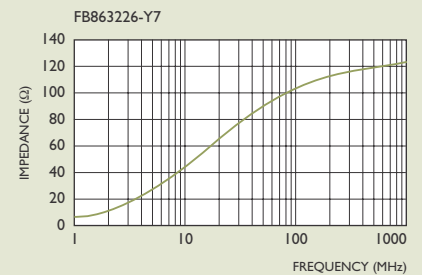
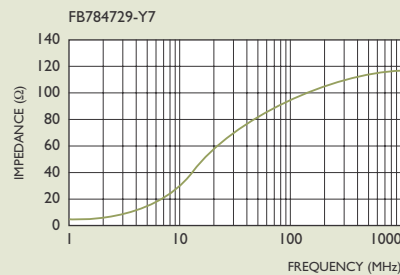
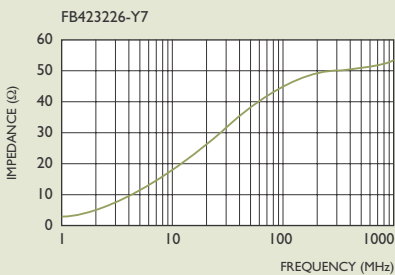



FB SERIES RELIABILITY TEST

I-1 MECHANICAL PERFORMANCE

NO.	ITEM	SPECIFICATION	TEST CONDITIONS
I-1-1	Vibration	Appearance : No Damage Z Change : within $\pm 20\%$ RDC : within Specification	Test device shall be soldered on the substrate. Oscillation Frequency : 10 to 55 to 10Hz for 1Min. Amplitude : 1.5mm Time : 2Hrs. for each Axis (X,Y & Z), Total 6Hrs.

I-2 ENVIRONMENTAL PERFORMANCE

NO.	ITEM	SPECIFICATION	TEST CONDITIONS															
I-2-1	Temperature Cycle	Appearance : No Damage Z Change : within $\pm 20\%$ RDC : within Specification	One Cycle <table border="1"> <thead> <tr> <th>Step</th> <th>Temperature ($^{\circ}\text{C}$)</th> <th>Time (Min.)</th> </tr> </thead> <tbody> <tr> <td>1</td> <td>-55 ± 3</td> <td>30</td> </tr> <tr> <td>2</td> <td>25 ± 2</td> <td>3</td> </tr> <tr> <td>3</td> <td>125 ± 3</td> <td>30</td> </tr> <tr> <td>4</td> <td>25 ± 2</td> <td>3</td> </tr> </tbody> </table> <p>Total : 100 Cycles Measured after Exposure in the Room Condition for 24Hrs.</p>	Step	Temperature ($^{\circ}\text{C}$)	Time (Min.)	1	-55 ± 3	30	2	25 ± 2	3	3	125 ± 3	30	4	25 ± 2	3
Step	Temperature ($^{\circ}\text{C}$)	Time (Min.)																
1	-55 ± 3	30																
2	25 ± 2	3																
3	125 ± 3	30																
4	25 ± 2	3																
I-2-2	Humidity Resistance		Temperature : $40 \pm 2^{\circ}\text{C}$ Relative Humidity : 90 ~ 95% Time : 1000Hrs. Measured after Exposure in the Room Condition for 24Hrs.															
I-2-3	High Temperature Resistance		Temperature : $125 \pm 3^{\circ}\text{C}$ Relative Humidity : 0% Time : 1000Hrs. Measured after Exposure in the Room Condition for 24Hrs.															
I-2-4	Low Temperature Resistance		Temperature : $-55 \pm 3^{\circ}\text{C}$ Relative Humidity : 0% Time : 1000Hrs. Measured after Exposure in the Room Condition for 24Hrs.															

EMI PC Beads

SBC Series

SBC0810F6H-Series
 SBC1010F8H-Series
 SBC1310F10H-Series



SBC0508F6HT-B

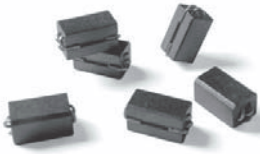

PRODUCT IDENTIFICATION

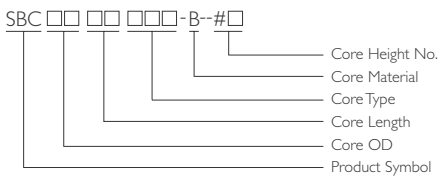

APPLICATIONS

The PC Beads mainly used in the PC board of personal computers, microcomputers and relative devices to filter the EMI from the outside.

OUTLINE

Yageo EMI PC Beads provide a powerful means of EMI/RFI attenuation for electronic equipment. Multiple single turn printed circuit beads or multi-turn printed circuit beads are available in three size in B material.

These beads are supplied with tinned copper jumper wires which complete the desired winding configuration on the printed circuit boards.

FEATURES

Jump wires are oxygen free and high conductivity copper with a 95/5 tin/lead coating.

Compact and High Performance

Easy Installation

ELECTRICAL CHARACTERISTICS

PART NO.	TYPICAL IMPEDANCE AT 100MHZ (Ω)					
	B-#1	B-#2	B-#3	B-#4	B-#5	B-#6
SBC0810F6H-	65 ⁻⁰	100 ⁻⁰	120 ⁻⁰	155 ⁻⁰	170 ⁻⁰	270 ⁻⁰
SBC1010F8H-	65 ⁻⁰	100 ⁻⁰	120 ⁻⁰	155 ⁻⁰	170 ⁻⁰	270 ⁻⁰
SBC1310F10H-	65 ⁻⁰	100 ⁻⁰	120 ⁻⁰	155 ⁻⁰	170 ⁻⁰	270 ⁻⁰

SHAPES AND DIMENSIONS

Dimensions : mm

SBC0810F6H-B# □

SBC1010F8H-B# □

SBC1310F10H-B# □

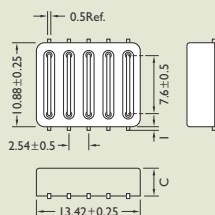
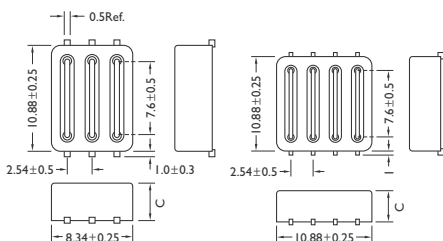

TYPE	A	B	C
SBC0810F6H-B# □	8.34	10.9	-#1 3.81 -#2 5.08
SBC1010F8H-B# □	10.88	10.9	-#3 6.35 -#4 7.62
SBC1310F10H-B# □	13.42	10.9	-#5 8.09 -#6 10.15



SHAPE AND DIMENSIONS

Dimensions : mm

SBC0508F6HT-B

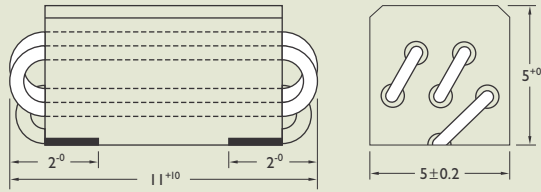

SBC1105F16HT-B246

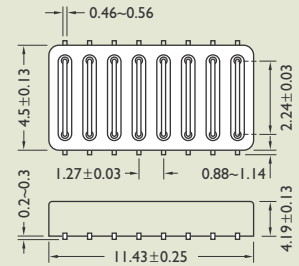

ELECTRICAL CHARACTERISTICS

PART NO.	IMPEDANCE	TEST FREQUENCY (MHz)	IMPEDANCE (Ω)	TEST FREQUENCY (MHz)	DC RESISTANCE ($m\Omega$) Max.
SBC0508F6HT-B	340^{-0}	25	$600 \pm 25\%$	100	7.5
SBC1105F16HT-B246	-	-	80^{-0}	100	10

TAPE DIMENSIONS

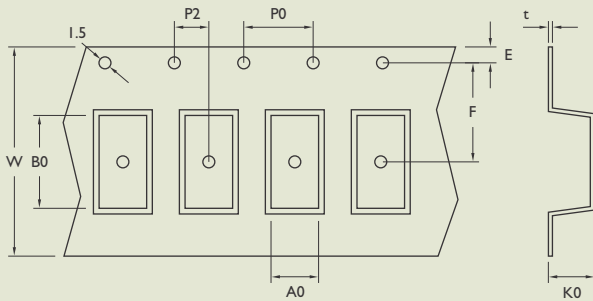

REEL DIMENSIONS

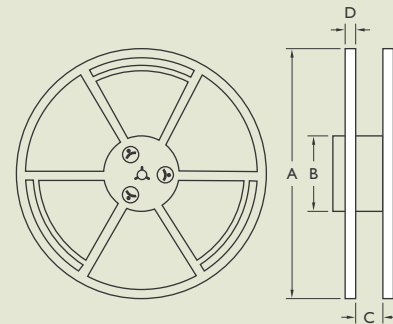

TAPE MATERIAL

Carrier Tape : Black Conductive Polystyrene - Alloy

Cover Type : Black Conductive Polystyrene - Alloy

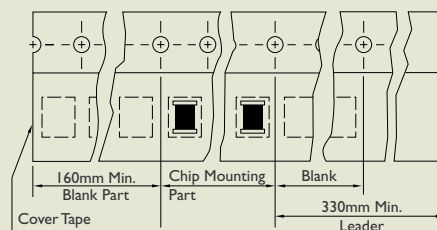

Dimensions : mm

TYPE	TAPE DIMENSIONS									REEL DIMENSIONS			QUANTITY
	W	E	F	P0	P2	A0	B0	K0	T	A	B	C	REEL/CARTON
SBC0508F6HT-B	24	1.75	11.5	4	2	5.3	10.9	5.1	0.35	330	100	24.4	1000/10000
SBC1105F16HT-B246	24	1.75	11.5	4	2	7.5	11.7	4.7	0.35	330	100	24.4	1000/10000



TYPICAL ELECTRICAL CHARACTERISTIC

Test Instruments : HP4291A RF Impedance Analyzer

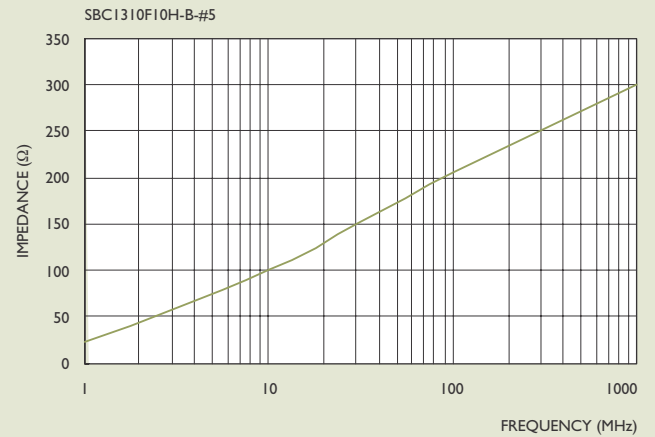
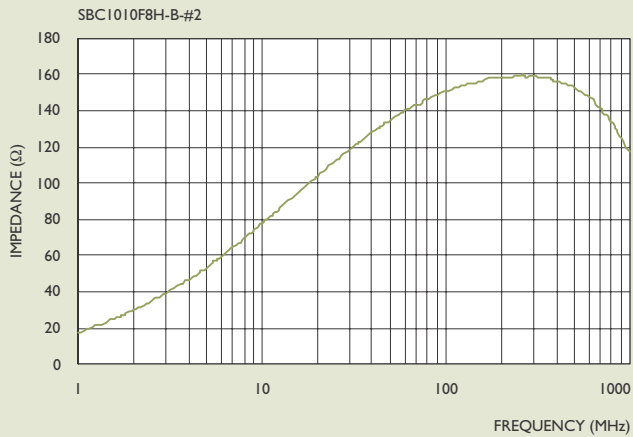
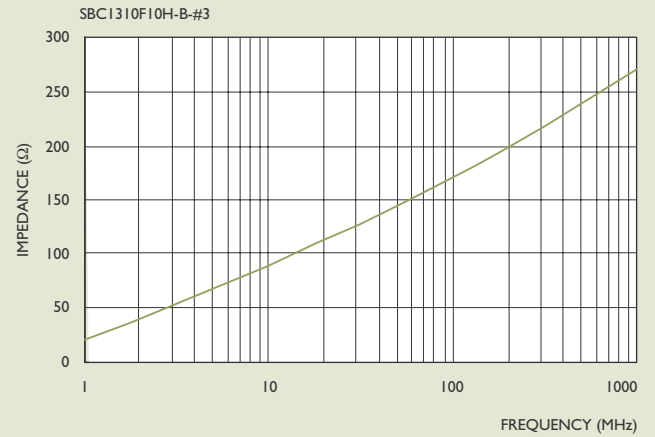
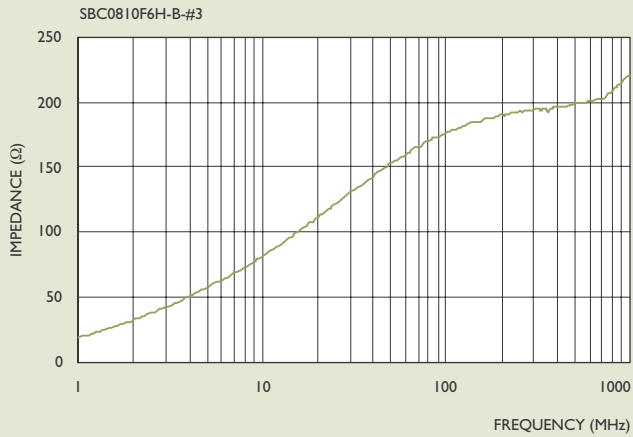
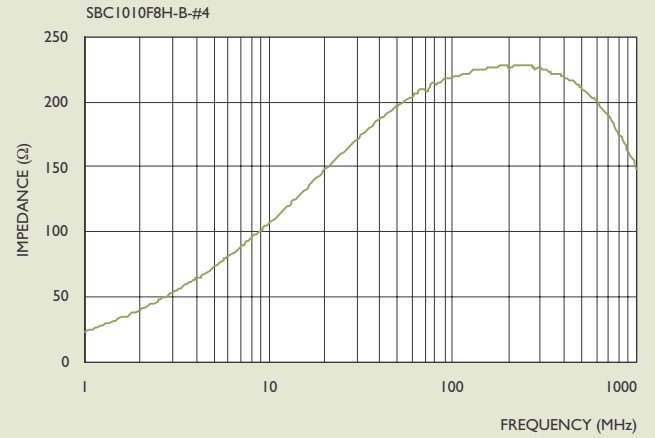
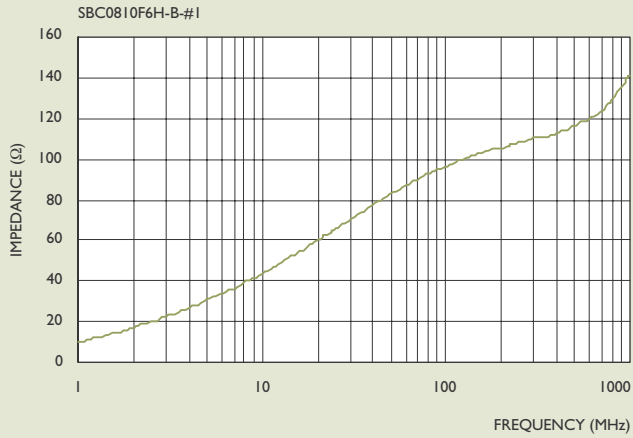

SBCB Series

Data Line EMI Filter

APPLICATIONS

Attenuating Noise of Analog and Digital Signals for Telecommunication Devices

Prevention of Interference from Amateur Radios, CB Stations, or High Frequency Welders, etc.

OUTLINE

These surface mount filters are specially designed to virtually eliminate the problem of conducted EMI in data line applications. They provide both differential and common mode noise attenuation.

These components contain tremendous electrode straight, solder heat resistance and outstanding solderability. These products are designed for flow, reflow and wave soldering required for surface mounting applications.

FEATURES

These components are compatible with auto insertion equipment and easy installed for PC board.

With Four Lines for Voice and Data Line

Compact and High Performance

ELECTRIAL CHARACTERISTICS

PART NO.	INDUCTANCE (μ H)	TEST FREQUENCY (KHz) 0.6V	DC RESISTANCE (Ω) Max.
SBCB1104RIT-330-B3	25 ~ 50	100	0.07



PRODUCT IDENTIFICATION

SBCB 1104 RI-□-□□□-B3



SHAPES AND DIMENSIONS

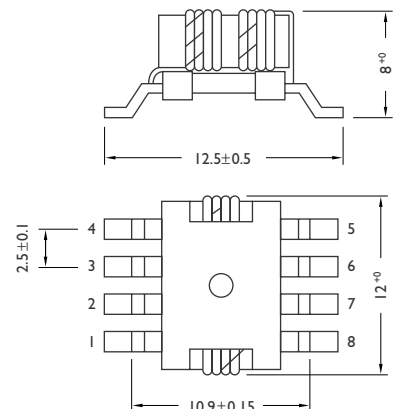

Dimensions : mm



TAPE DIMENSIONS

Dimensions : mm

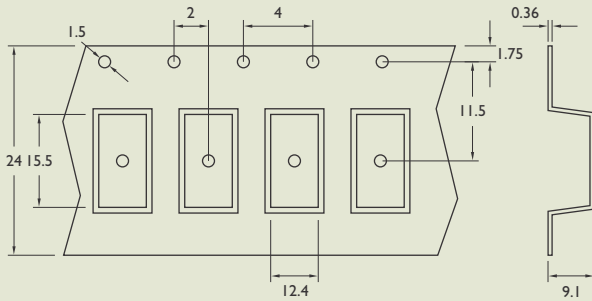

TAPE MATERIAL

Carrier Tape : Black Conductive Polystyrene - Alloy

Cover Type : Black Conductive Polystyrene - Alloy

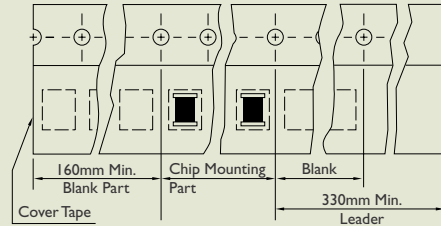

REEL DIMENSIONS

Dimensions : mm

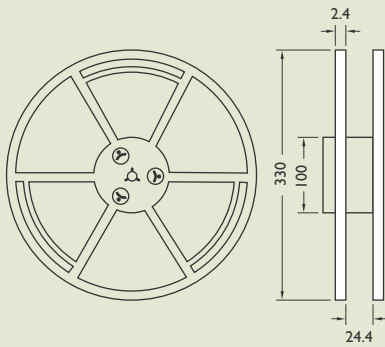

RECOMMENDED PATTERN

Dimensions : mm

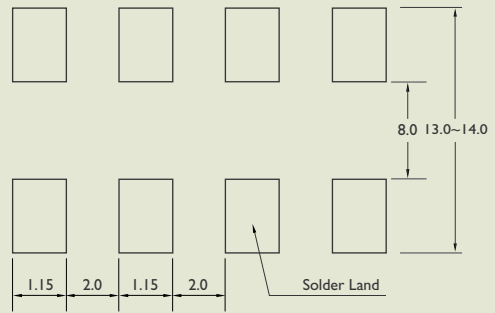

PACKAGING QUANTITY

TYPE

QUANTITY/REEL

SBCBI 104

350

TYPICAL ELECTRICAL CHARACTERISTICS

Test Instruments : HP4192A LF Impedance Analyzer

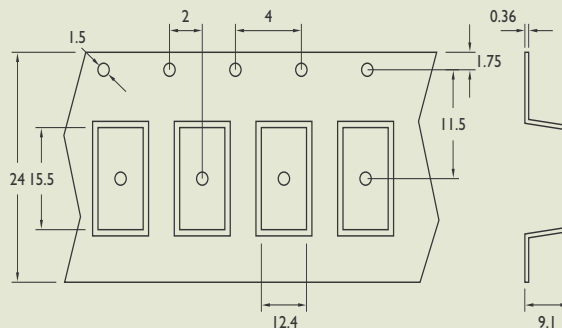



SBCBI I04 SERIES RELIABILITY TEST

I-1 MECHANICAL PERFORMANCE

NO.	ITEM	SPECIFICATION	TEST CONDITIONS
I-1-1	Vibration	Appearance : No Damage L Change : within $\pm 10\%$ Q Change : within $\pm 30\%$ RDC : within Specification	Test device shall be soldered on the substrate. Oscillation Frequency : 10 to 55 to 10Hz for 1Min. Amplitude : 1.5mm Time : 2Hrs. for each Axis (X,Y & Z), Total 6Hrs.
I-1-2	Resistance to Soldering Heat	Appearance : No Damage	Pre-heating : 150°C, 1Min. Solder Composition : Sn/Pb = 63/37 Solder Temperature : 260 \pm 5°C Immersion Time : 10 \pm 1Sec.
I-1-3	Solderability	The electrodes shall be at least 90% covered with new solder coating.	Pre-heating : 150°C, 1Min. Solder Composition : Sn/Pb = 63/37 Solder Temperature : 230 \pm 5°C Immersion Time : 4 \pm 1Sec.

I-2 ENVIRONMENTAL PERFORMANCE

NO.	ITEM	SPECIFICATION	TEST CONDITIONS															
I-2-1	Temperature Shock	Appearance : No Damage L Change : within $\pm 10\%$ L Change : within $\pm 30\%$ RDC : within Specification	10 Cycles (Air to Air) 1 Cycles shall Consist of : 30Min. Exposure to -55°C 30Min. Exposure to 125°C 15Sec. Max. Transition between Temperatures Measured after Exposure in the Room Condition for 24Hrs.															
I-2-2	Temperature Cycle		One Cycle <table border="1"> <thead> <tr> <th>Step</th> <th>Temperature (°C)</th> <th>Time (Min.)</th> </tr> </thead> <tbody> <tr> <td>1</td> <td>-25 \pm 3</td> <td>30</td> </tr> <tr> <td>2</td> <td>25 \pm 2</td> <td>3</td> </tr> <tr> <td>3</td> <td>85 \pm 3</td> <td>30</td> </tr> <tr> <td>4</td> <td>25 \pm 2</td> <td>3</td> </tr> </tbody> </table> Total : 100 Cycles Measured after Exposure in the Room Condition for 24Hrs.	Step	Temperature (°C)	Time (Min.)	1	-25 \pm 3	30	2	25 \pm 2	3	3	85 \pm 3	30	4	25 \pm 2	3
Step	Temperature (°C)	Time (Min.)																
1	-25 \pm 3	30																
2	25 \pm 2	3																
3	85 \pm 3	30																
4	25 \pm 2	3																
I-2-3	Humidity Resistance		Temperature : 40 \pm 2°C Relative Humidity : 90 ~ 95% Time : 1000Hrs. Measured after Exposure in the Room Condition for 24Hrs.															
I-2-4	High Temperature Resistance		Temperature : 85 \pm 3°C Relative Humidity : 20% Applied Current : Rated Current Time : 1000Hrs. Measured after Exposure in the Room Condition for 24Hrs.															
I-2-5	Low Temperature Resistance		Temperature : -25 \pm 3°C Relative Humidity : 0% Time : 1000Hrs. Measured after Exposure in the Room Condition for 24Hrs.															

EMC Data Line Filter

SBCB Series

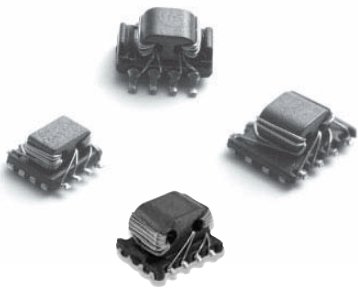

PRODUCT IDENTIFICATION

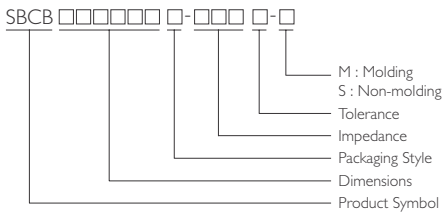

FEATURES

Dual Common Mode

For High Speed Digital Data; Ex : IEEE1394 (Fire Wire), USB

Low Profile

SHAPES AND DIMENSIONS

TYPE	DIMENSION
------	-----------

SBCB656030-S

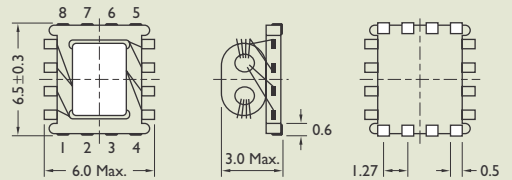
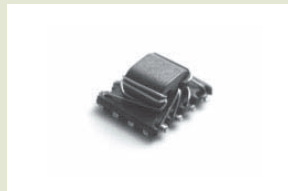

SBCB656030-M

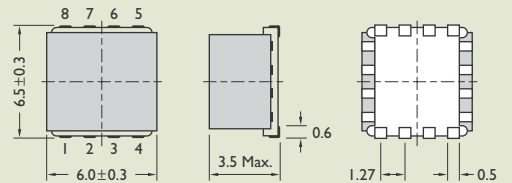

SBCB454525-S, SBCB454525-M

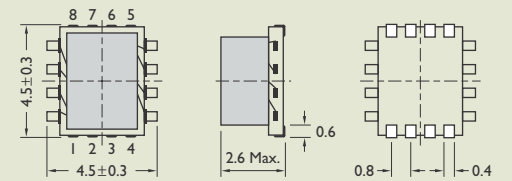
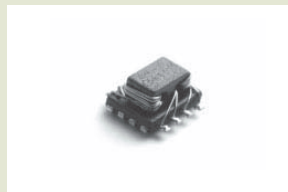

SBCB657030-S

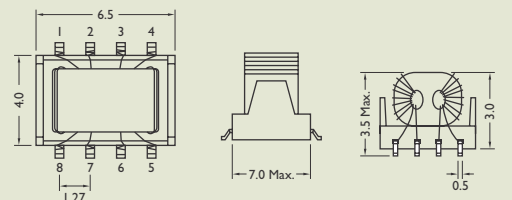



ELECTRICAL CHARACTERISTICS

ITEM	IMPEDANCE (Ω)			
	1MHz	10MHz	100MHz	200MHz
SBCB656030T-700-S	—	—	70Min.	105Min.
SBCB656030T-700-M	—	—	—	—
SBCB656030T-181-S	—	—	180Min.	250Min.
SBCB656030T-181-M	—	—	—	—
SBCB656030T-371-S	—	—	365Min.	335Min.
SBCB656030T-371-M	—	—	—	—
SBCB454525T-101-S	—	—	105Min.	160Min.
SBCB454525T-101-M	—	—	—	—
SBCB454525T-201-S	—	—	200Min.	280Min.
SBCB454525T-201-M	—	—	—	—
SBCB454525T-351-M	—	—	345Min.	360Min.
SBCB454525T-600-M	—	—	60Min.	215Min.
SBCB657030T-151-S	2.8TYP	29TYP	150Min.	—

ITEM	INSERTION LOSS (dB)				DC RESISTANCE (Ω) Max.	RATED CURRENT (A) Max.
	50MHz	100MHz	300MHz	500MHz		
SBCB656030T-700-S	3.1 \pm 1.5	5.8 \pm 2.5	8.7 \pm 2.5	9.3 \pm 3	0.1	0.65
SBCB656030T-700-M	—	—	—	—	—	—
SBCB656030T-181-S	6.8 \pm 2.5	10.5 \pm 3	13.5 \pm 3	11.5 \pm 3	0.1	0.65
SBCB656030T-181-M	—	—	—	—	—	—
SBCB656030T-371-S	10.8 \pm 3	15.3 \pm 3	14.5 \pm 3	9.8 \pm 3	0.1	0.65
SBCB656030T-371-M	—	—	—	—	—	—
SBCB454525T-101-S	4.5 \pm 2	7.5 \pm 3	11.0 \pm 3	11.5 \pm 3	0.3	0.50
SBCB454525T-101-M	—	—	—	—	—	—
SBCB454525T-201-S	7.5 \pm 2.5	11.5 \pm 3	14.8 \pm 3	12.3 \pm 3	0.3	0.50
SBCB454525T-201-M	—	—	—	—	—	—
SBCB454525T-351-M	10.5 \pm 3	15.0 \pm 3	15.5 \pm 3	11.0 \pm 3	0.3	0.50
SBCB454525T-600-M	2.0 Max.	3.0 \pm 1.5	15 \pm 3	15.5 \pm 3	0.3	0.50
SBCB657030T-151-S	5 \pm 2	8 \pm 3	12 \pm 3	14 \pm 3	0.12	0.5

NOTES : * Rated Voltage : DC 50V

* Withstanding Voltage : DC 200V 60Sec. or DC 240V 1~2Sec. (Coil-Coil) I = 1mA

* Insulation Resistance : DC 100V 10MOHM Min. (Coil-Coil)

* Operating Temperature Range : -25 to +80°C

* Storage Temperature Range : -40 to +120°C



PACKAGING

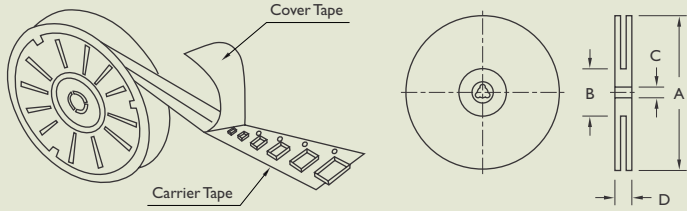

SBCB656030-S SBCB656030-M SBCB454525

	SBCB656030-S	SBCB656030-M	SBCB454525
Pcs/Reel	1000	1000	2000
A	330mm	330mm	330mm
B	100mm	100mm	100mm
C	13.0mm	13.0mm	13.0mm
D	21.0mm	21.0mm	17.1mm

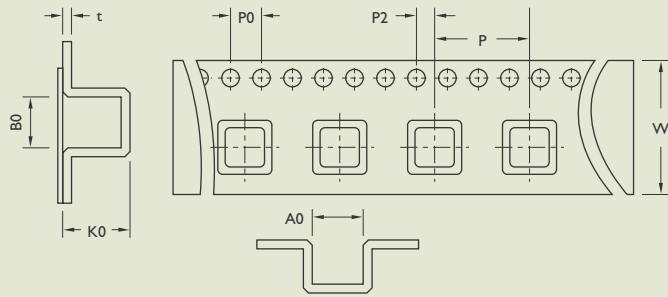

SBCB656030-S SBCB656030-M SBCB454525

	SBCB656030-S	SBCB656030-M	SBCB454525
A0	6.9	6.9	5.0
B0	6.1	6.1	5.0
K0	3.2	3.5	2.9
P	12	12	8
P0	4.0	4.0	4.0
P2	2.0	2.0	2.0
W	16.0	16.0	12.0
t	0.4	0.4	0.3

RECOMMENDED PATTERN

SBCB656030

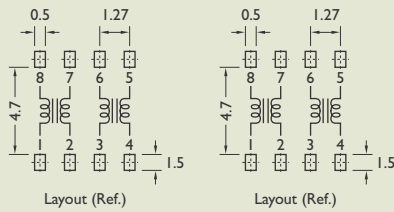

SBCB454525

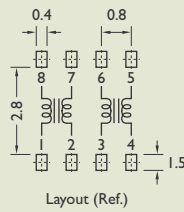

SBCB657030T-151-S

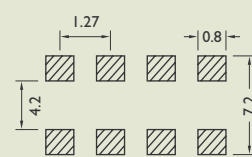

Applications
Twisted Pair Cable Interface

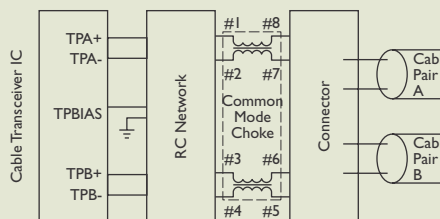

IEEE 1394 Port

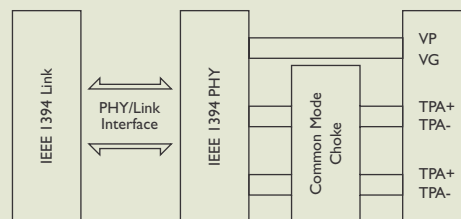



ATTENUATION RESPONSE & IMPEDANCE

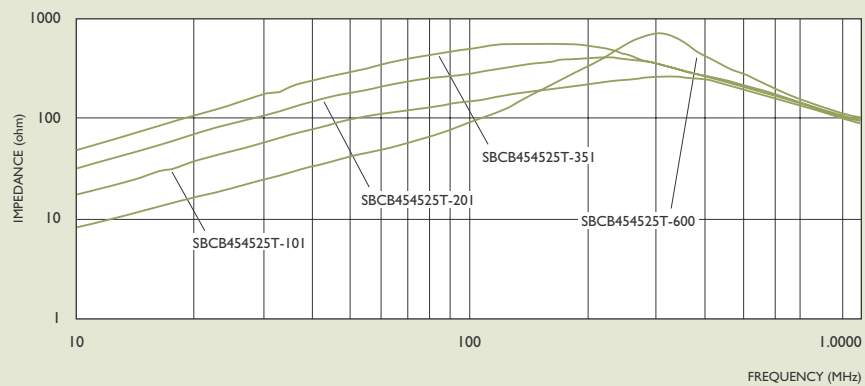
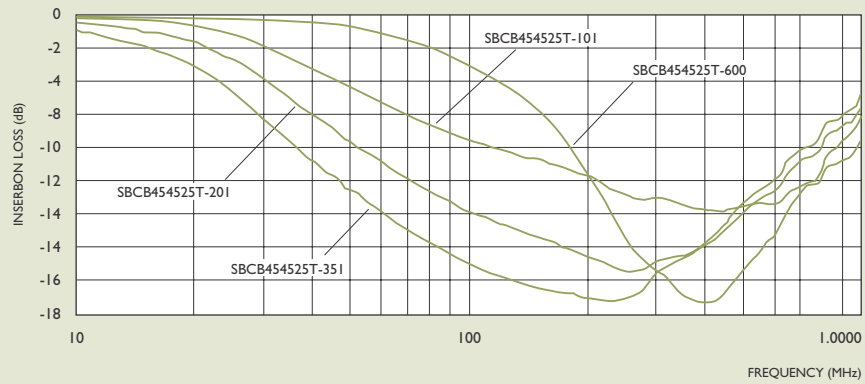
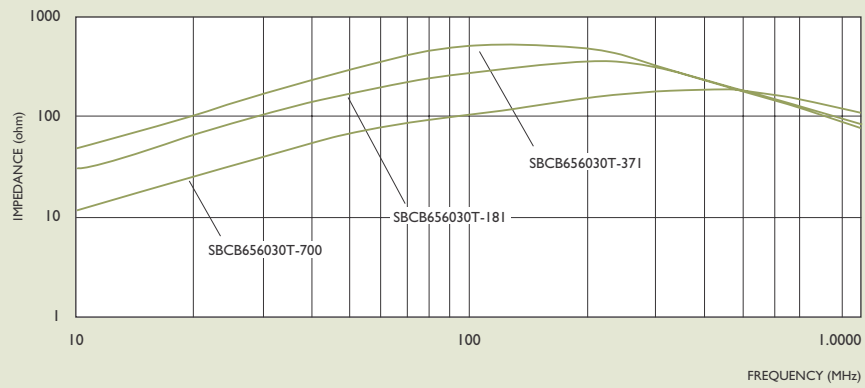
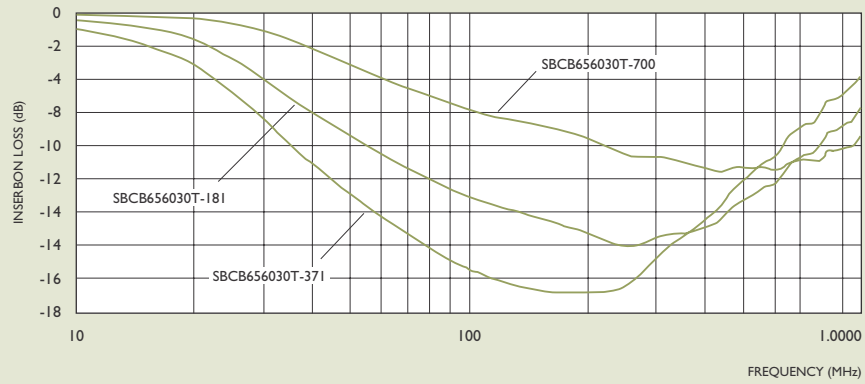

Multilayer Chip Inductors

CL Series



PRODUCT IDENTIFICATION

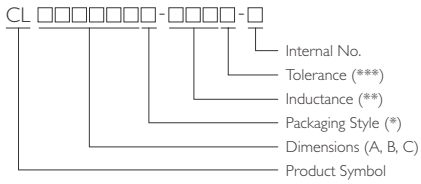

- * B: Bulk ; T: Tape and Reel
- ** Example : 47N = 47nH
R10 = 0.1μH IR0 = 1.0μH
- *** K = ±10% M = ±20%

APPLICATIONS

Personal computers, HDDs, or other various electronic appliances.

Any general circuit of portable equipment in which compact size and high mounting densities are required.

OUTLINE

Yageo's SMD multi-layered chip inductors provide a cost effective solution for densely packed PC board designs. Using Ferrite or CL / CLH series ceramic materials are available in broad band and high frequency circuits. The ferrite structure is suited for lower frequency applications and the ceramic one, CLH series, is designed to meet the needs of higher frequency circuits.

FEATURES

High mounting density of compact circuit due to crosstalk elimination that results from a closed magnetic flux in a ferrite material.

Suitable for Flow and Re-flow Soldering

Available in 5 Sizes

SHAPES AND DIMENSIONS

Dimensions : mm

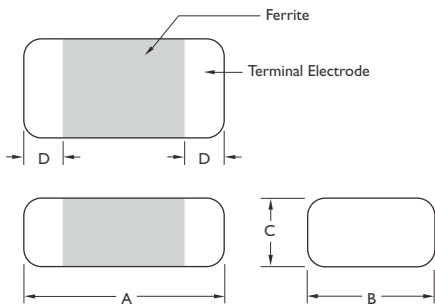

TYPE	A	B	C	D
CL160808	1.6 ± 0.20	0.80 ± 0.15	0.80 ± 0.15	0.3 ± 0.2
CL201209	2.0 ± 0.20	1.25 ± 0.20	0.90 ± 0.20	0.5 ± 0.3
CL201212	2.0 ± 0.20	1.25 ± 0.20	1.25 ± 0.20	0.5 ± 0.3
CL321611	3.2 ± 0.20	1.60 ± 0.20	1.10 ± 0.20	0.5 ± 0.3



ELECTRICAL CHARACTERISTICS CLI60808 (0603) SERIES

PART NO.	INDUCTANCE (μ H)	TOLERANCE (\pm %)	Q Min.	TEST FREQUENCY (MHz)	SRF (MHz) Min.	DC RESISTANCE (Ω) Max.	IDC (mA) Max.
CLI60808T-10NM-S	0.010	20%	15	50	300	0.20	50
CLI60808T-33NM-S	0.033	20%	15	50	270	0.20	50
CLI60808T-47NM-S	0.047	20%	15	50	260	0.30	50
CLI60808T-68NM-S	0.068	20%	15	50	250	0.30	50
CLI60808T-82NM-S	0.082	20%	15	50	245	0.30	50
CLI60808T-R10□-S	0.10	20 or 10%	25	25	240	0.50	50
CLI60808T-R12□-S	0.12	20 or 10%	25	25	205	0.50	50
CLI60808T-R15□-S	0.15	20 or 10%	25	25	180	0.60	50
CLI60808T-R18□-S	0.18	20 or 10%	25	25	165	0.60	50
CLI60808T-R22□-S	0.22	20 or 10%	25	25	150	0.80	50
CLI60808T-R27□-S	0.27	20 or 10%	25	25	136	0.80	50
CLI60808T-R33□-S	0.33	20 or 10%	25	25	125	0.85	35
CLI60808T-R39□-S	0.39	20 or 10%	25	25	110	1.00	35
CLI60808T-R47□-S	0.47	20 or 10%	25	25	105	1.35	35
CLI60808T-R56□-S	0.56	20 or 10%	25	25	95	1.50	35
CLI60808T-R68□-S	0.68	20 or 10%	25	25	85	1.70	35
CLI60808T-R82□-S	0.82	20 or 10%	25	25	75	2.10	35
CLI60808T-1R0□-S	1.0	20 or 10%	35	10	65	0.60	25
CLI60808T-1R2□-S	1.2	20 or 10%	35	10	60	0.80	25
CLI60808T-1R5□-S	1.5	20 or 10%	35	10	55	0.80	25
CLI60808T-1R8□-S	1.8	20 or 10%	35	10	50	0.95	25
CLI60808T-2R2□-S	2.2	20 or 10%	35	10	45	1.10	15
CLI60808T-2R7□-S	2.7	20 or 10%	35	10	40	1.30	15
CLI60808T-3R3□-S	3.3	20 or 10%	35	10	38	1.50	15
CLI60808T-3R9□-S	3.9	20 or 10%	35	10	36	1.70	15
CLI60808T-4R7□-S	4.7	20 or 10%	35	10	33	2.10	15
CLI60808T-5R6□-S	5.6	20 or 10%	35	4	22	1.50	5
CLI60808T-6R8□-S	6.8	20 or 10%	35	4	20	1.70	5
CLI60808T-8R2□-S	8.2	20 or 10%	30	4	18	2.10	5
CLI60808T-100□-S	10	20 or 10%	30	2	17	2.55	5



ELECTRICAL CHARACTERISTICS CL201209, CL201212 (0805) SERIES

PART NO.	INDUCTANCE (μ H)	TOLERANCE (\pm %)	Q Min.	TEST FREQUENCY (MHz)	SRF (MHz) Min.	DC RESISTANCE (Ω) Max.	IDC (mA) Max.
CL201209T-47NM-S	0.047	20%	20	50	320	0.20	300
CL201209T-68NM-S	0.068	20%	20	50	280	0.20	300
CL201209T-82NM-S	0.082	20%	20	50	255	0.20	300
CL201209T-R10□-S	0.10	20 or 10%	25	25	235	0.30	250
CL201209T-R12□-S	0.12	20 or 10%	25	25	220	0.30	250
CL201209T-R15□-S	0.15	20 or 10%	25	25	200	0.40	250
CL201209T-R18□-S	0.18	20 or 10%	25	25	185	0.40	250
CL201209T-R22□-S	0.22	20 or 10%	25	25	170	0.50	250
CL201209T-R27□-S	0.27	20 or 10%	25	25	150	0.50	250
CL201209T-R33□-S	0.33	20 or 10%	25	25	145	0.55	250
CL201209T-R39□-S	0.39	20 or 10%	25	25	135	0.65	250
CL201209T-R47□-S	0.47	20 or 10%	25	25	125	0.65	250
CL201209T-R56□-S	0.56	20 or 10%	25	25	115	0.75	150
CL201209T-R68□-S	0.68	20 or 10%	25	25	105	0.80	150
CL201209T-R82□-S	0.82	20 or 10%	25	25	100	1.00	150
CL201209T-1R0□-S	1.0	20 or 10%	45	10	75	0.40	50
CL201209T-1R2□-S	1.2	20 or 10%	45	10	65	0.50	50
CL201209T-1R5□-S	1.5	20 or 10%	45	10	60	0.50	50
CL201209T-1R8□-S	1.8	20 or 10%	45	10	55	0.60	50
CL201209T-2R2□-S	2.2	20 or 10%	45	10	50	0.65	30
CL201212T-2R7□-S	2.7	20 or 10%	45	10	45	0.75	30
CL201212T-3R3□-S	3.3	20 or 10%	45	10	41	0.80	30
CL201212T-3R9□-S	3.9	20 or 10%	45	10	38	0.90	30
CL201212T-4R7□-S	4.7	20 or 10%	45	10	35	1.00	30
CL201212T-5R6□-S	5.6	20 or 10%	45	4	32	0.90	15
CL201212T-6R8□-S	6.8	20 or 10%	45	4	29	1.00	15
CL201212T-8R2□-S	8.2	20 or 10%	45	4	26	1.10	15
CL201212T-100□-S	10	20 or 10%	45	2	24	1.10	15
CL201212T-120□-S	12	20 or 10%	45	2	22	1.20	15
CL201212T-150□-S	15	20 or 10%	30	1	19	0.80	5
CL201212T-180□-S	18	20 or 10%	30	1	18	0.90	5
CL201212T-220□-S	22	20 or 10%	30	1	16	1.10	5



ELECTRICAL CHARACTERISTICS CL321611 (1206) SERIES

PART NO.	INDUCTANCE (μ H)	TOLERANCE ($\pm\%$)	Q Min.	TEST FREQUENCY (MHz)	SRF (MHz) Min.	DC RESISTANCE (Ω) Max.	IDC (mA) Max.
CL321611T-47NM-S	0.047	20%	20	50	320	0.15	300
CL321611T-68NM-S	0.068	20%	20	50	280	0.25	300
CL321611T-82NM-S	0.082	20%	20	50	250	0.25	300
CL321611T-R10□-S	0.10	20 or 10%	25	25	235	0.25	250
CL321611T-R12□-S	0.12	20 or 10%	25	25	220	0.30	250
CL321611T-R15□-S	0.15	20 or 10%	25	25	200	0.30	250
CL321611T-R18□-S	0.18	20 or 10%	25	25	185	0.40	250
CL321611T-R22□-S	0.22	20 or 10%	25	25	170	0.40	250
CL321611T-R27□-S	0.27	20 or 10%	25	25	150	0.50	250
CL321611T-R33□-S	0.33	20 or 10%	25	25	145	0.60	250
CL321611T-R39□-S	0.39	20 or 10%	25	25	135	0.50	200
CL321611T-R47□-S	0.47	20 or 10%	25	25	125	0.60	200
CL321611T-R56□-S	0.56	20 or 10%	25	25	115	0.70	150
CL321611T-R68□-S	0.68	20 or 10%	25	25	105	0.80	150
CL321611T-R82□-S	0.82	20 or 10%	25	25	100	0.90	150
CL321611T-1R0□-S	1.0	20 or 10%	45	10	75	0.40	100
CL321611T-1R2□-S	1.2	20 or 10%	45	10	65	0.50	100
CL321611T-1R5□-S	1.5	20 or 10%	45	10	60	0.50	80
CL321611T-1R8□-S	1.8	20 or 10%	45	10	55	0.50	70
CL321611T-2R2□-S	2.2	20 or 10%	45	10	50	0.60	60
CL321611T-2R7□-S	2.7	20 or 10%	45	10	45	0.60	60
CL321611T-3R3□-S	3.3	20 or 10%	45	10	41	0.70	60
CL321611T-3R9□-S	3.9	20 or 10%	45	10	38	0.80	50
CL321611T-4R7□-S	4.7	20 or 10%	45	10	35	0.90	50
CL321611T-5R6□-S	5.6	20 or 10%	45	4	32	0.70	25
CL321611T-6R8□-S	6.8	20 or 10%	45	4	29	0.80	25
CL321611T-8R2□-S	8.2	20 or 10%	45	4	26	0.90	25
CL321611T-100□-S	10	20 or 10%	45	2	24	1.00	25
CL321611T-120□-S	12	20 or 10%	45	2	22	1.00	15
CL321611T-150□-S	15	20 or 10%	35	1	19	0.70	5
CL321611T-180□-S	18	20 or 10%	35	1	18	0.75	5
CL321611T-220□-S	22	20 or 10%	35	1	16	0.90	5
CL321611T-270□-S	27	20 or 10%	35	1	14	0.90	5
CL321611T-330□-S	33	20 or 10%	35	1	13	1.05	5



TAPE DIMENSIONS

Dimensions : mm

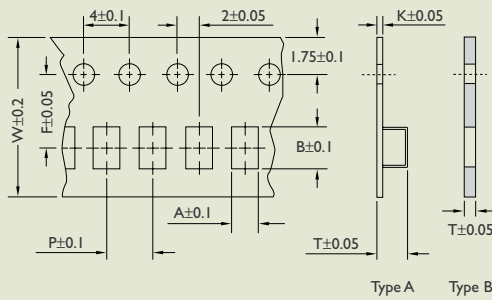

TYPE	A	B	T	W	P	F	K	TAPE TYPE
CL160808	1.05	1.9	0.95	8.0	4.0	3.5	–	B
CL201209	1.54	2.30	1.05	8.0	4.0	3.5	0.2	A
CL201212	1.40	2.25	1.40	8.0	4.0	3.5	0.2	A
CL321611	1.88	3.50	1.27	8.0	4.0	3.5	0.2	A

TAPE MATERIAL

Carrier Tape : Polystyrene (for 201209, 201212, 321611 Series), Paper (for 160808)
 Cover Tape : Polyethyene

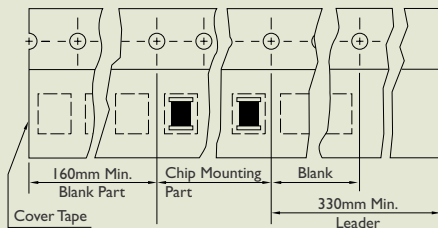

REEL DIMENSIONS

Dimensions : mm

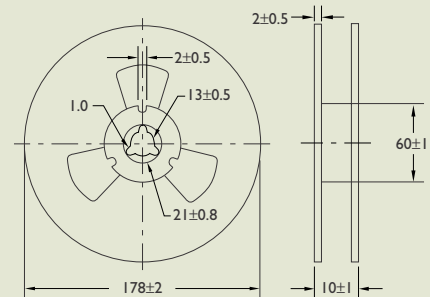

RECOMMENDED PATTERN

Dimensions : mm

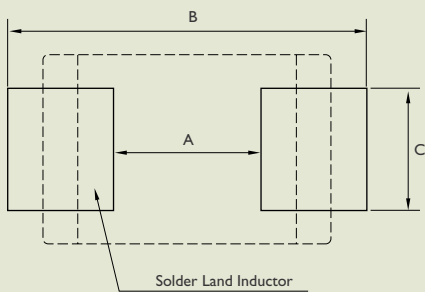

TYPE	A	B	C
CL160808	0.8	2.4 ~ 3.4	0.6
CL201209	1.2	3.0 ~ 4.0	1.0
CL201212	1.2	3.0 ~ 4.0	1.0
CL321611	2.0	4.2 ~ 5.2	1.2

PACKAGING QUANTITY

TYPE	BULK	QUANTITY/REEL
CL160808	√	4000
CL201209	√	4000
CL201212	√	3000
CL321611	√	3000



TYPICAL ELECTRICAL CHARACTERISTICS

Test Instruments : HP4291A Impedance / Material Analyzer

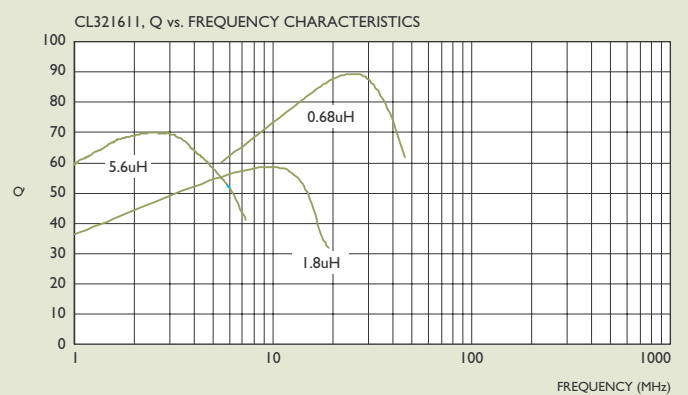
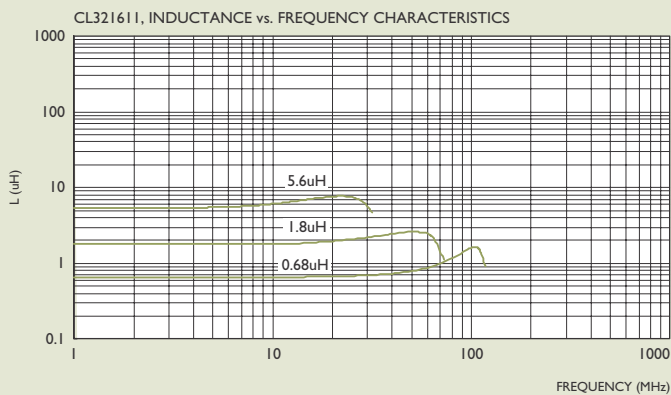
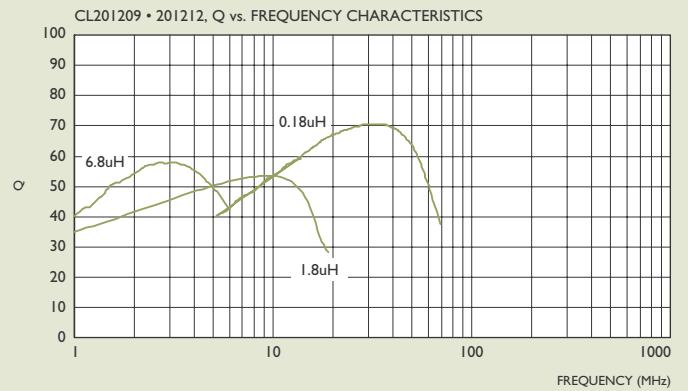
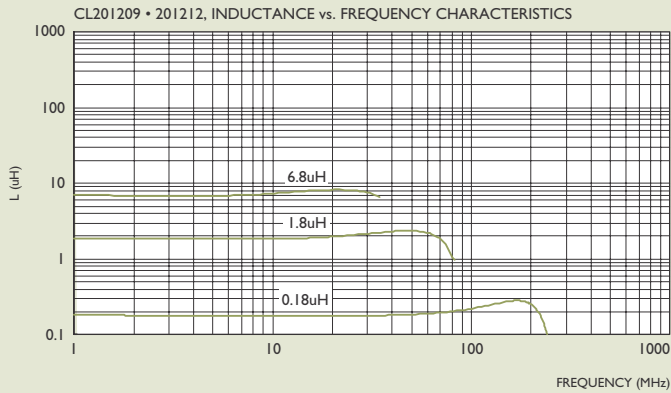
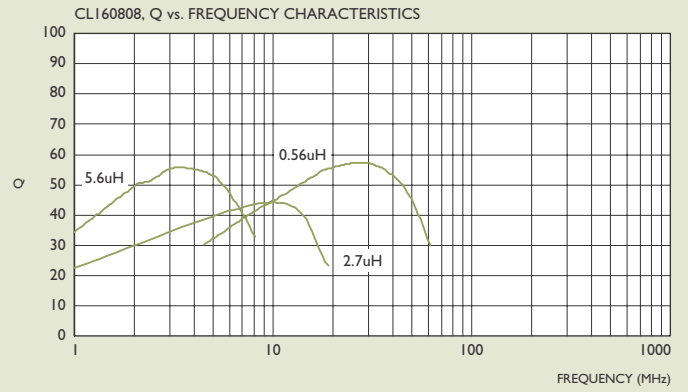
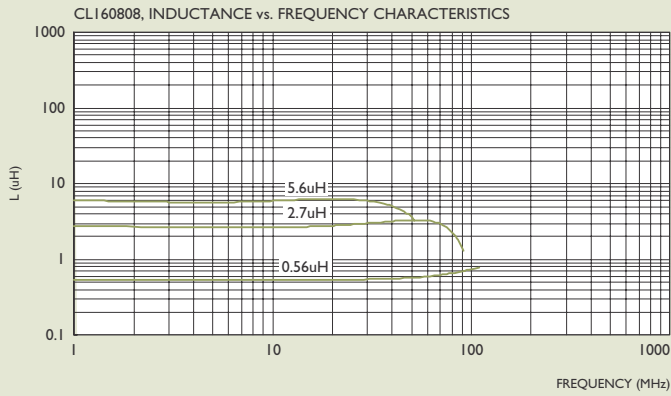



CL SERIES RELIABILITY TEST

I-1 MECHANICAL PERFORMANCE

NO.	ITEM	SPECIFICATION	TEST CONDITIONS
I-1-1	Flexure Strength	Appearance : No Damage L Change : within $\pm 10\%$ Q Change : within $\pm 30\%$	Test device shall be soldered on the substrate. Substrate Dimension : 100 x 40 x 1.6mm Deflection : 2.0mm Keeping Time : 30Sec. * For 100505, substrate dimension is 100 x 40 x 0.8mm.
I-1-2	Vibration		Test device shall be soldered on the substrate. Oscillation Frequency : 10 to 55 to 10Hz for 1Min. Amplitude : 1.5mm Time : 2Hrs. for each Axis (X,Y & Z), Total 6Hrs.
I-1-3	Resistance to Soldering Heat	Appearance : No Damage	Pre-heating : 150°C, 1Min. Solder Composition : Sn/Pb = 63/37 Solder Temperature : 260 \pm 5°C Immersion Time : 10 \pm 1Sec.
I-1-4	Solderability	The electrodes shall be at least 90% covered with new solder coating.	Pre-heating : 150°C, 1Min. Solder Composition : Sn/Pb = 63/37 Solder Temperature : 230 \pm 5°C Immersion Time : 4 \pm 1Sec.

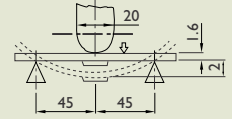

I-2 ENVIRONMENTAL PERFORMANCE

NO.	ITEM	SPECIFICATION	TEST CONDITIONS															
I-2-1	Temperature Cycle	Appearance : No Damage L Change : within $\pm 10\%$ Q Change : within $\pm 30\%$	One Cycle <table border="1"> <thead> <tr> <th>Step</th> <th>Temperature (°C)</th> <th>Time (Min.)</th> </tr> </thead> <tbody> <tr> <td>1</td> <td>-25 \pm 3</td> <td>30</td> </tr> <tr> <td>2</td> <td>25 \pm 2</td> <td>3</td> </tr> <tr> <td>3</td> <td>85 \pm 3</td> <td>30</td> </tr> <tr> <td>4</td> <td>25 \pm 2</td> <td>3</td> </tr> </tbody> </table> Total : 100 Cycles Measured after Exposure in the Room Condition for 24Hrs.	Step	Temperature (°C)	Time (Min.)	1	-25 \pm 3	30	2	25 \pm 2	3	3	85 \pm 3	30	4	25 \pm 2	3
Step	Temperature (°C)	Time (Min.)																
1	-25 \pm 3	30																
2	25 \pm 2	3																
3	85 \pm 3	30																
4	25 \pm 2	3																
I-2-2	Humidity Resistance		Temperature : 40 \pm 2°C Relative Humidity : 90 ~ 95% Time : 1000Hrs. Measured after Exposure in the Room Condition for 24Hrs.															
I-2-3	High Temperature Resistance		Temperature : 85 \pm 3°C Relative Humidity : 20% Applied Current : Rated Current Time : 1000Hrs. Measured after Exposure in the Room Condition for 24Hrs.															
I-2-4	Low Temperature Resistance		Temperature : -25 \pm 3°C Relative Humidity : 0% Time : 1000Hrs. Measured after Exposure in the Room Condition for 24Hrs.															

SQV Series

Miniature Surface Mount Chip Inductors

APPLICATIONS

Personal, Cordless Phone

High Freq. Communication Products

GPS (Global Position System)

Personal Computers

FEATURES

This miniature chip inductors wound on a special ferrite core.

High Q value at high frequencies and low DC resistance.

Wide Inductance Range

Excellent solder heat resistance. Both flow and reflow soldering methods can be employed.

SHAPES AND DIMENSIONS

TYPE	A	B	C	E	F	G
322520	3.2 ± 0.3	2.5 ± 0.2	2.0 ± 0.2	1.5	1.0	2.0
453226	4.5 ± 0.3	3.2 ± 0.2	2.6 ± 0.2	2.0	1.2	3.0

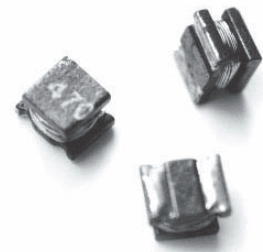

PRODUCT IDENTIFICATION

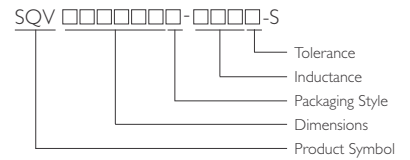

Dimensions : mm

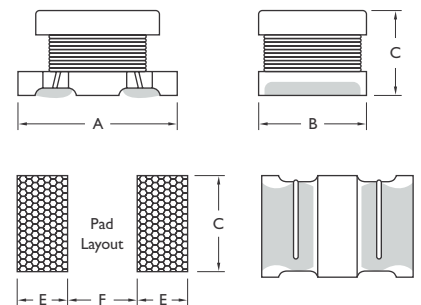



ELECTRICAL CHARACTERISTICS

PART NO.	INDUCTANCE (μ H)			QUALITY FACTOR		DC RESISTANCE (Ω) Max.	SRF (MHz) Min.	IDC (mA) Max.
	NOMINAL VALUE	TOLERANCE (\pm %)	TEST FREQUENCY	SPEC. Min.	TEST FREQUENCY			
SQV322520T-R10□-S	0.10	20	1MHz	20	25.2MHz	0.25	200	700
SQV322520T-R18□-S	0.18	20	1MHz	20	25.2MHz	0.25	200	650
SQV322520T-R27□-S	0.27	20	1MHz	25	25.2MHz	0.25	200	600
SQV322520T-R39□-S	0.39	20	1MHz	25	25.2MHz	0.25	200	530
SQV322520T-R56□-S	0.56	20	1MHz	30	25.2MHz	0.25	160	530
SQV322520T-R68□-S	0.68	20	1MHz	30	25.2MHz	0.25	160	470
SQV322520T-R82□-S	0.82	20	1MHz	30	25.2MHz	0.25	120	450
SQV322520T-1R0□-S	1.0	20	1MHz	20	1MHz	0.50	100	445
SQV322520T-1R2□-S	1.2	20	1MHz	20	1MHz	0.60	100	425
SQV322520T-1R5□-S	1.5	10/20	1MHz	20	1MHz	0.60	75	400
SQV322520T-1R8□-S	1.8	10/20	1MHz	20	1MHz	0.70	60	390
SQV322520T-2R2□-S	2.2	10/20	1MHz	20	1MHz	0.80	50	370
SQV322520T-2R7□-S	2.7	10/20	1MHz	20	1MHz	0.90	43	320
SQV322520T-3R3□-S	3.3	10/20	1MHz	20	1MHz	1.0	38	300
SQV322520T-3R9□-S	3.9	10/20	1MHz	20	1MHz	1.1	35	290
SQV322520T-4R7□-S	4.7	10/20	1MHz	20	1MHz	1.2	31	270
SQV322520T-5R6□-S	5.6	10/20	1MHz	20	1MHz	1.3	28	250
SQV322520T-6R8□-S	6.8	10/20	1MHz	20	1MHz	1.5	25	240
SQV322520T-8R2□-S	8.2	10/20	1MHz	20	1MHz	1.6	23	225
SQV322520T-100□-S	10	5/10	1MHz	35	1MHz	1.8	20	190
SQV322520T-120□-S	12	5/10	1MHz	35	1MHz	2.0	18	180
SQV322520T-150□-S	15	5/10	1MHz	35	1MHz	2.2	16	170
SQV322520T-180□-S	18	5/10	1MHz	35	1MHz	2.5	15	165
SQV322520T-220□-S	22	5/10	1MHz	35	1MHz	2.8	14	150
SQV322520T-270□-S	27	5/10	1MHz	35	1MHz	3.1	13	125
SQV322520T-330□-S	33	5/10	1MHz	40	1MHz	3.5	12	115
SQV322520T-390□-S	39	5/10	1MHz	40	1MHz	3.9	11	110
SQV322520T-470□-S	47	5/10	1MHz	40	1MHz	4.3	11	100
SQV322520T-560□-S	56	5/10	1MHz	40	1MHz	4.9	10.0	85
SQV322520T-680□-S	68	5/10	1MHz	40	1MHz	5.5	9.0	80
SQV322520T-820□-S	82	5/10	1MHz	40	1MHz	6.2	8.5	70
SQV322520T-101□-S	100	5/10	1MHz	40	796KHz	7.0	8.0	80
SQV322520T-121□-S	120	5/10	1MHz	40	796KHz	8.0	7.5	75
SQV322520T-151□-S	150	5/10	1MHz	40	796KHz	9.3	7.0	70
SQV322520T-181□-S	180	5/10	1MHz	40	796KHz	10.2	6.0	65
SQV322520T-221□-S	220	5/10	1MHz	40	796KHz	11.8	5.5	65
SQV322520T-271□-S	270	5/10	1MHz	40	796KHz	12.5	5.0	65
SQV322520T-331□-S	330	5/10	1MHz	40	796KHz	13.0	5.0	65
SQV322520T-391□-S	390	5/10	1MHz	50	796KHz	22.0	5.0	50
SQV322520T-471□-S	470	5/10	1KHz	50	796KHz	25.0	5.0	45
SQV322520T-561□-S	560	5/10	1KHz	50	796KHz	28.0	5.0	40



ELECTRICAL CHARACTERISTICS

PART NO.	INDUCTANCE (μH)			QUALITY FACTOR		DC RESISTANCE (Ω) Max.	SRF (MHz) Min.	IDC (mA) Max.
	NOMINAL VALUE	TOLERANCE (±%)	TEST FREQUENCY	SPEC. Min.	TEST FREQUENCY			
SQV453226T-1R0□-S	1.0	20	1MHz	20	1MHz	0.20	120	500
SQV453226T-1R2□-S	1.2	20	1MHz	20	1MHz	0.20	100	500
SQV453226T-1R5□-S	1.5	20	1MHz	20	1MHz	0.30	85	500
SQV453226T-1R8□-S	1.8	20	1MHz	20	1MHz	0.30	75	500
SQV453226T-2R2□-S	2.2	20	1MHz	20	1MHz	0.30	62	500
SQV453226T-2R7□-S	2.7	20	1MHz	20	1MHz	0.32	53	500
SQV453226T-3R3□-S	3.3	20	1MHz	20	1MHz	0.35	47	500
SQV453226T-3R9□-S	3.9	20	1MHz	20	1MHz	0.38	41	500
SQV453226T-4R7□-S	4.7	10/20	1MHz	30	1MHz	0.40	38	500
SQV453226T-5R6□-S	5.6	10/20	1MHz	30	1MHz	0.47	33	500
SQV453226T-6R8□-S	6.8	10/20	1MHz	30	1MHz	0.50	31	450
SQV453226T-8R2□-S	8.2	10/20	1MHz	30	1MHz	0.56	27	450
SQV453226T-100□-S	10	5/10	1MHz	35	1MHz	0.56	23	400
SQV453226T-120□-S	12	5/10	1MHz	35	1MHz	0.62	21	380
SQV453226T-150□-S	15	5/10	1MHz	35	1MHz	0.73	19	360
SQV453226T-180□-S	18	5/10	1MHz	35	1MHz	0.82	17	340
SQV453226T-220□-S	22	5/10	1MHz	35	1MHz	0.94	15	320
SQV453226T-270□-S	27	5/10	1MHz	35	1MHz	1.1	14	300
SQV453226T-330□-S	33	5/10	1MHz	35	1MHz	1.2	12	270
SQV453226T-390□-S	39	5/10	1MHz	35	1MHz	1.4	11	240
SQV453226T-470□-S	47	5/10	1MHz	35	1MHz	1.5	10	220
SQV453226T-560□-S	56	5/10	1MHz	35	1MHz	1.7	9.3	200
SQV453226T-680□-S	68	5/10	1MHz	35	1MHz	1.9	8.4	180
SQV453226T-820□-S	82	5/10	1MHz	35	1MHz	2.2	7.5	170
SQV453226T-101□-S	100	5/10	1MHz	40	796KHz	2.5	6.8	160
SQV453226T-121□-S	120	5/10	1MHz	40	796KHz	3.0	6.2	150
SQV453226T-151□-S	150	5/10	1MHz	40	796KHz	3.7	5.5	130
SQV453226T-181□-S	180	5/10	1MHz	40	796KHz	4.5	5.0	120
SQV453226T-221□-S	220	5/10	1MHz	40	796KHz	5.4	4.5	110
SQV453226T-271□-S	270	5/10	1MHz	40	796KHz	6.8	4.0	100
SQV453226T-331□-S	330	5/10	1MHz	40	796KHz	8.2	3.6	95
SQV453226T-391□-S	390	5/10	1MHz	40	796KHz	9.7	3.3	90
SQV453226T-471□-S	470	5/10	1KHz	40	796KHz	11.8	3.0	80
SQV453226T-561□-S	560	5/10	1KHz	40	796KHz	14.5	2.7	70
SQV453226T-681□-S	680	5/10	1KHz	40	796KHz	17.5	2.5	65
SQV453226T-821□-S	820	5/10	1KHz	40	796KHz	20.5	2.2	60
SQV453226T-102□-S	1000	5/10	1KHz	40	252KHz	25.0	2.0	50
SQV453226T-122□-S	1200	5/10	1KHz	40	252KHz	30.0	1.8	45
SQV453226T-152□-S	1500	5/10	1KHz	40	252KHz	37.0	1.6	40
SQV453226T-182□-S	1800	5/10	1KHz	40	252KHz	45.0	1.5	35
SQV453226T-222□-S	2200	5/10	1KHz	40	252KHz	50.0	1.3	30

- Inductance Range 0.1 uH to 2200 uH
- Operating Temp -25°C ~ 85°C
- Test Equipment L & Q : HP4285A Precision LCR Meter
SRF : HP4291B RF Impedance Analyzer
DCR : Milliohm Meter
- Inductance Tolerance J = ±5% K = ±10% M = ±20%

- Current Rating Based on Temperature Rise not Exceeding 20°C
- Soldering Heat 230°C 10 Sec. after 150°C Preheat Cycle for 4 Min.



TAPE DIMENSIONS

Dimensions : mm

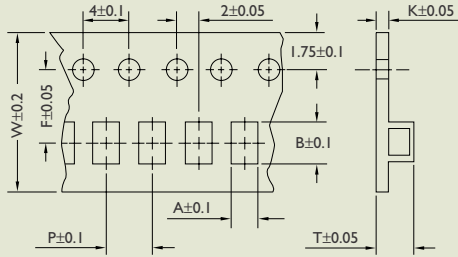

TAPE MATERIAL

Carrier Tape : Polystyrene

Cover Type : Polyethylene

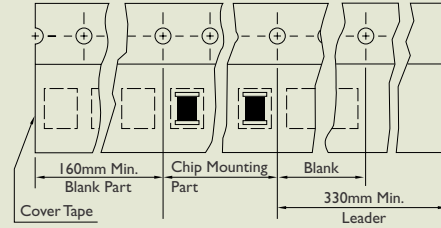

REEL DIMENSIONS

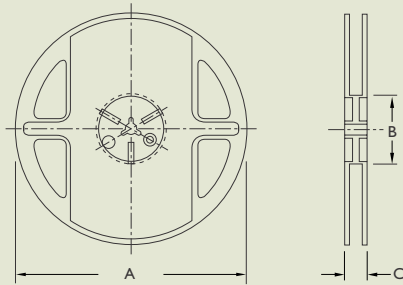

RECOMMENDED PATTERN

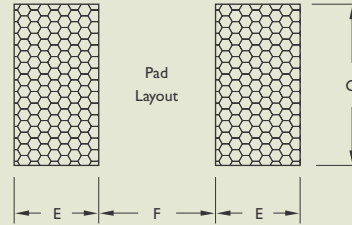

Dimensions : mm

TYPE	TAPE DIMENSIONS							REEL DIMENSIONS			RECOMMENDED PATTERN			QUANTITY /REEL
	A	B	T	W	P	F	K	A	B	C	E	F	G	
SQV322520	2.88	3.65	2.50	8	4	3.5	0.22	178	50	9	1.5	1.0	2.0	2000
SQV453226	3.31	4.88	3.45	12	8	5.5	0.35	178	80	13	2.0	1.2	3.0	500



ELECTRICAL CHARACTERISTICS

PART NO.	INDUCTANCE (μ H)	TOLERANCE (\pm %)	TEST FREQUENCY (MHz)	DC RESISTANCE (Ω) Max.	SRF (Mhz) Min.	IDC (mA) Max.
SQC321618T-R12□-S	0.12	20	25.2	0.112	250	970
SQC321618T-R22□-S	0.22	20	25.2	0.140	250	850
SQC321618T-R47□-S	0.47	20	25.2	0.210	180	700
SQC321618T-1R0□-S	1.0	20	7.96	0.364	100	510
SQC321618T-2R2□-S	2.2	20	7.96	0.533	50	430
SQC321618T-4R7□-S	4.7	10 / 20	7.96	0.845	31	340
SQC321618T-100□-S	10	5 / 10	2.52	1.690	20	230
SQC321618T-220□-S	22	5 / 10	2.52	3.900	14	160
SQC321618T-470□-S	47	5 / 10	2.52	10.40	10	100
SQC321618T-101□-S	100	5 / 10	0.796	15.60	7	80
SQC322520T-1R0□-S	1.0	20	7.96	0.078	100	1000
SQC322520T-2R2□-S	2.2	20	7.96	0.126	64	790
SQC322520T-4R7□-S	4.7	20	7.96	0.195	43	450
SQC322520T-100□-S	10	20	2.52	0.572	26	300
SQC322520T-220□-S	22	10/20	2.52	0.923	19	250
SQC322520T-470□-S	47	10/20	2.52	1.69	15	170
SQC322520T-101□-S	100	5/10	0.796	4.55	10	100
SQC322520T-221□-S	220	5/10	0.796	10.92	6.8	70
SQC322520T-331□-S	330	5/10	0.796	13.00	5.6	60
SQC322520T-391□-S	390	5/10	0.796	22.10	5.0	60
SQC322520T-471□-S	470	5/10	0.796	24.70	5.0	60
SQC322520T-561□-S	560	5/10	0.796	28.60	5.0	60
SQC453226T-1R0□-S	1.0	20	7.96	0.08	100	1080
SQC453226T-1R5□-S	1.5	20	7.96	0.09	85	1000
SQC453226T-2R2□-S	2.2	20	7.96	0.11	60	900
SQC453226T-3R3□-S	3.3	20	7.96	0.13	47	800
SQC453226T-4R7□-S	4.7	10/20	7.96	0.15	35	750
SQC453226T-6R8□-S	6.8	10/20	7.96	0.20	30	720
SQC453226T-100□-S	10	5/10	2.52	0.24	23	650
SQC453226T-150□-S	15	5/10	2.52	0.32	20	570
SQC453226T-220□-S	22	5/10	2.52	0.60	15	420
SQC453226T-330□-S	33	5/10	2.52	1.0	12	310
SQC453226T-470□-S	47	5/10	2.52	1.1	10	280
SQC453226T-680□-S	68	5/10	2.52	1.7	8.4	220
SQC453226T-101□-S	100	5/10	796kHz	2.2	6.8	190
SQC453226T-151□-S	150	5/10	796kHz	3.5	5.5	130
SQC453226T-221□-S	220	5/10	796kHz	4.0	4.5	110
SQC453226T-331□-S	330	5/10	796kHz	6.8	3.6	100
SQC453226T-471□-S	470	5/10	796kHz	8.5	3.0	90
SQC575047T-R12□-S	0.12	20	100kHz	0.0098	450	6000
SQC575047T-R27□-S	0.27	20	100kHz	0.0140	300	5300



ELECTRICAL CHARACTERISTICS

PART NO.	INDUCTANCE (μ H)	TOLERANCE (\pm %)	TEST FREQUENCY (MHz)	DC RESISTANCE (Ω) Max.	SRF (Mhz) Min.	IDC (mA) Max.
SQC575047T-R47□-S	0.47	20	100kHz	0.0182	200	4800
SQC575047T-1R0□-S	1.0	20	100kHz	0.0270	150	4000
SQC575047T-1R5□-S	1.5	20	100kHz	0.0310	110	3700
SQC575047T-2R2□-S	2.2	20	100kHz	0.0410	80	3200
SQC575047T-3R3□-S	3.3	20	100kHz	0.0500	40	2900
SQC575047T-4R7□-S	4.7	20	100kHz	0.0574	30	2700
SQC575047T-6R8□-S	6.8	20	100kHz	0.1040	25	2000
SQC575047T-100□-S	10	10/20	100kHz	0.1300	20	1700
SQC575047T-150□-S	15	10/20	100kHz	0.210	17	1400
SQC575047T-220□-S	22	10/20	100kHz	0.266	15	1200
SQC575047T-330□-S	33	10/20	100kHz	0.448	12	900
SQC575047T-470□-S	47	10/20	100kHz	0.560	10	800
SQC575047T-680□-S	68	10/20	100kHz	0.938	7.6	640
SQC575047T-101□-S	100	10/20	100kHz	1.204	6.5	560
SQC575047T-151□-S	150	10/20	100kHz	2.660	5.0	420
SQC575047T-221□-S	220	10/20	100kHz	3.360	4.0	320
SQC575047T-331□-S	330	10/20	100kHz	6.160	3.1	270
SQC575047T-471□-S	470	10/20	100kHz	7.560	2.4	240
SQC575047T-681□-S	680	10/20	100kHz	11.34	1.9	190
SQC575047T-102□-S	1000	10/20	100kHz	14.42	1.7	150
SQC575047T-222□-S	2200	10/20	100kHz	30.10	1.2	100
SQC575047T-472□-S	4700	10/20	100kHz	61.04	0.8	70
SQC575047T-103□-S	10000	10/20	100kHz	140.0	0.5	50

- Inductance Range 0.12 uH to 10000 uH.
- Current Rating Based on temperature rise not exceeding 20°C and inductance is 90% more than its nominal value.
- Operating Temp. -25°C ~ 85°C
- Soldering Heat 230°C 10 Seconds after 150°C Preheat Cycle for 4 Minutes
- Test Equipment L : HP4285A Precision LCR Meter
SRF : HP4291B RF Impedance Analyzer
DCR : Milliohm Meter
- Inductance Tolerance J = \pm 5% K = \pm 10% M = \pm 20%



TAPE DIMENSIONS

Dimensions : mm

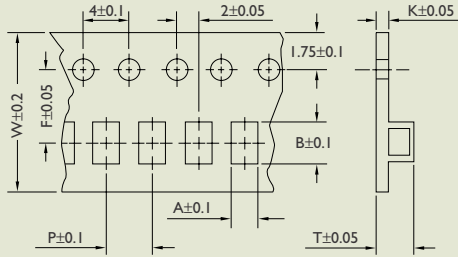

TAPE MATERIAL

Carrier Tape : Polystyrene

Cover Type : Polyethylene

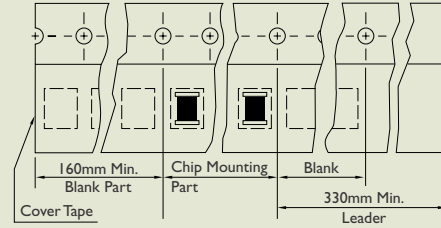

REEL DIMENSIONS

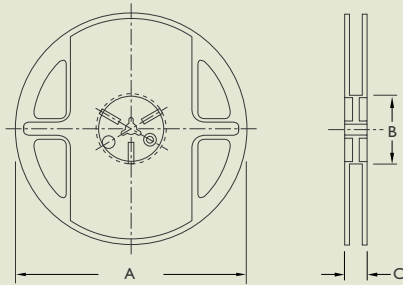

RECOMMENDED PATTERN

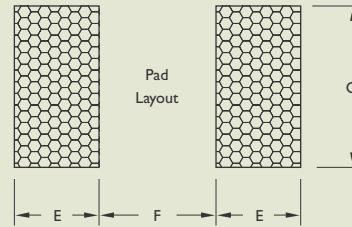

Dimensions : mm

TYPE	TAPE DIMENSIONS							REEL DIMENSIONS			RECOMMENDED PATTERN			QUANTITY /REEL
	A	B	T	W	P	F	K	A	B	C	E	F	G	
SQC321618	1.88	3.53	2.10	8	4	3.5	0.22	178	50	9	1.5	1.0	1.5	2000
SQC322520	2.88	3.65	2.50	8	4	3.5	0.22	178	50	9	1.5	1.0	2.0	2000
SQC453226	3.31	4.88	3.45	12	8	5.5	0.35	178	80	13	2.0	1.2	3.0	500
SQC575047	5.40	6.00	5.50	16	12	7.5	0.40	330	100	17	2.0	2.0	5.0	1000



NL Series

Wound Chip Inductors

APPLICATIONS

Microtelevisions, liquid crystal televisions, video cameras, portable VCRs, car radios, car stereos, thin tape radios, television tuners, mobile telephones, radio and other electronic devices.

OUTLINE

These revolutionary, highly reliable wound chip inductors for automatic mounting have been developed in response to the trend toward high density in electronic equipment.

With metal terminals and a body of heat resistant resin, these inductors offer many superior features.

FEATURES

Very strong solderability by flow soldering, soldering iron or wave soldering.

Highly accurate dimensions; can be mounted automatically.

Terminals are highly resistant to pull forces.

Highly resistant to mechanical shocks and pressure.

Highly reliable in environments of sudden temperature change and humidity. Super Q characteristics.

SHAPES AND DIMENSIONS

NL322522

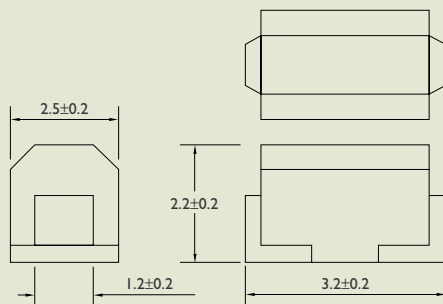

NL453232

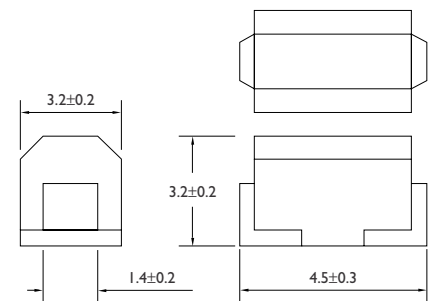

Dimensions : mm

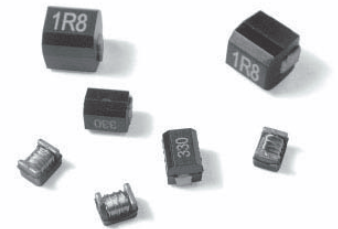

PRODUCT IDENTIFICATION

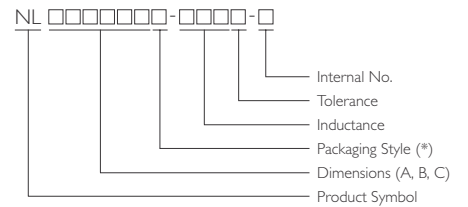

* T : Tape and Reel ; B : Bulk



ELECTRICAL CHARACTERISTICS NL322522 SERIES

PART NO.	INDUCTANCE (μ H)	TOLERANCE (\pm %)	Q Min.	TEST FREQUENCY (MHz)	SRF (MHz) Min.	DC RESISTANCE (Ω) Max.	IDC (mA) Max.
NL322522T-010K-S	0.010	10	15	100	2500	0.13	450
NL322522T-012K-S	0.012	10	17	100	2300	0.14	450
NL322522T-015K-S	0.015	10	19	100	2100	0.16	450
NL322522T-018K-S	0.018	10	21	100	1900	0.18	450
NL322522T-022K-S	0.022	10	23	100	1700	0.20	450
NL322522T-027K-S	0.027	10	23	100	1500	0.22	450
NL322522T-033K-S	0.033	10	25	100	1400	0.24	450
NL322522T-039K-S	0.039	10	25	100	1300	0.27	450
NL322522T-047K-S	0.047	10	26	100	1200	0.30	450
NL322522T-056K-S	0.056	10	26	100	1100	0.33	450
NL322522T-068K-S	0.068	10	27	100	1000	0.36	450
NL322522T-082K-S	0.082	10	27	100	900	0.40	450
NL322522T-R10K-S	0.10	10	28	100	700	0.44	450
NL322522T-R12K-S	0.12	10	30	25.20	500	0.22	450
NL322522T-R15K-S	0.15	10	30	25.20	450	0.25	450
NL322522T-R18K-S	0.18	10	30	25.20	400	0.28	450
NL322522T-R22K-S	0.22	10	30	25.20	350	0.32	450
NL322522T-R27K-S	0.27	10	30	25.20	320	0.36	450
NL322522T-R33K-S	0.33	10	30	25.20	300	0.40	450
NL322522T-R39K-S	0.39	10	30	25.20	250	0.45	450
NL322522T-R47K-S	0.47	10	30	25.20	220	0.50	450
NL322522T-R56K-S	0.56	10	30	25.20	180	0.55	450
NL322522T-R68K-S	0.68	10	30	25.20	160	0.60	450
NL322522T-R82K-S	0.82	10	30	25.20	140	0.65	450
NL322522T-1R0K-S	1.00	10	30	7.960	120	0.70	400
NL322522T-1R2K-S	1.20	10	30	7.960	100	0.75	390
NL322522T-1R5K-S	1.50	10	30	7.960	85	0.85	370
NL322522T-1R8K-S	1.80	10	30	7.960	80	0.90	350
NL322522T-2R2K-S	2.20	10	30	7.960	75	1.00	320
NL322522T-2R7K-S	2.70	10	30	7.960	70	1.10	290
NL322522T-3R3K-S	3.30	10	30	7.960	60	1.20	260
NL322522T-3R9K-S	3.90	10	30	7.960	55	1.30	250



ELECTRICAL CHARACTERISTICS NL322522 SERIES

PART NO.	INDUCTANCE (μ H)	TOLERANCE (\pm %)	Q Min.	TEST FREQUENCY (MHz)	SRF (MHz) Min.	DC RESISTANCE (Ω) Max.	IDC (mA) Max.
NL322522T-4R7K-S	4.70	10	30	7.960	50	1.50	220
NL322522T-5R6K-S	5.60	10	30	7.960	45	1.60	200
NL322522T-6R8K-S	6.80	10	30	7.960	40	1.80	180
NL322522T-8R2K-S	8.20	10	30	7.960	35	2.00	170
NL322522T-100K-S	10	10	30	2.520	30	2.10	150
NL322522T-120K-S	12	10	30	2.520	20	2.50	140
NL322522T-150K-S	15	10	30	2.520	20	2.80	130
NL322522T-180K-S	18	10	30	2.520	20	3.30	120
NL322522T-220K-S	22	10	30	2.520	20	3.70	110
NL322522T-270K-S	27	10	30	2.520	20	5.00	80
NL322522T-330K-S	33	10	30	2.520	17	5.60	70
NL322522T-390K-S	39	10	30	2.520	16	6.40	65
NL322522T-470K-S	47	10	30	2.520	15	7.00	60
NL322522T-560K-S	56	10	30	2.520	13	8.00	55
NL322522T-680K-S	68	10	30	2.520	12	9.00	50
NL322522T-820K-S	82	10	30	2.520	11	10.0	45
NL322522T-101K-S	100	10	20	0.796	10	10.0	40
NL322522T-121K-S	120	10	20	0.796	10	11.0	70
NL322522T-151K-S	150	10	20	0.796	8	15.0	65
NL322522T-181K-S	180	10	20	0.796	7	17.0	60
NL322522T-221K-S	220	10	20	0.796	7	21.0	50
NL322522T-271K-S	270	10	20	0.796	6	28.0	45
NL322522T-331K-S	330	10	20	0.796	5	34.0	40

Test Instruments : HP4286A RF Impedance Analyzer for L, Q, SRF
Digital Multimeter SC-740I for RDC
HP4285A LF Impedance Analyzer for L, Q
Chen-Hwa 106I+Chen-Wha 301A for IDC



ELECTRICAL CHARACTERISTICS NL453232 SERIES

PART NO.	INDUCTANCE (μ H)	TOLERANCE (\pm %)	Q Min.	TEST FREQUENCY (MHz)	SRF (MHz) Min.	DC RESISTANCE (Ω) Max.	IDC (mA) Max.
NL453232T-R10M-S	0.10	20	28	25.20	700	0.44	450
NL453232T-R12M-S	0.12	20	30	25.20	500	0.22	450
NL453232T-R15M-S	0.15	20	30	25.20	450	0.25	450
NL453232T-R18M-S	0.18	20	30	25.20	400	0.28	450
NL453232T-R22M-S	0.22	20	30	25.20	350	0.32	450
NL453232T-R27M-S	0.27	20	30	25.20	320	0.36	450
NL453232T-R33M-S	0.33	20	30	25.20	300	0.40	450
NL453232T-R39M-S	0.39	20	30	25.20	250	0.45	450
NL453232T-R47M-S	0.47	20	30	25.20	220	0.50	450
NL453232T-R56M-S	0.56	20	30	25.20	180	0.55	450
NL453232T-R68M-S	0.68	20	30	25.20	160	0.60	450
NL453232T-R82M-S	0.82	20	30	25.20	140	0.67	450
NL453232T-1R0K-S	1.00	10	50	7.960	100	0.50	450
NL453232T-1R2K-S	1.20	10	50	7.960	80	0.55	430
NL453232T-1R5K-S	1.50	10	50	7.960	70	0.60	410
NL453232T-1R8K-S	1.80	10	50	7.960	60	0.65	390
NL453232T-2R2K-S	2.20	10	50	7.960	55	0.70	380
NL453232T-2R7K-S	2.70	10	50	7.960	50	0.75	370
NL453232T-3R3K-S	3.30	10	50	7.960	45	0.80	355
NL453232T-3R9K-S	3.90	10	50	7.960	40	0.90	330
NL453232T-4R7K-S	4.70	10	50	7.960	35	1.00	315
NL453232T-5R6K-S	5.60	10	50	7.960	33	1.10	300
NL453232T-6R8K-S	6.80	10	50	7.960	27	1.20	285
NL453232T-8R2K-S	8.20	10	50	7.960	25	1.40	270
NL453232T-100K-S	10	10	50	2.520	20	1.60	250
NL453232T-120K-S	12	10	50	2.520	18	2.00	225
NL453232T-150K-S	15	10	50	2.520	17	2.50	200
NL453232T-180K-S	18	10	50	2.520	15	2.80	190
NL453232T-220K-S	22	10	50	2.520	13	3.20	180
NL453232T-270K-S	27	10	50	2.520	12	3.60	170
NL453232T-330K-S	33	10	50	2.520	11	4.00	160
NL453232T-390K-S	39	10	50	2.520	10	4.50	150
NL453232T-470K-S	47	10	50	2.520	10	5.00	140
NL453232T-560K-S	56	10	50	2.520	9	5.50	135
NL453232T-680K-S	68	10	50	2.520	9	6.00	130
NL453232T-820K-S	82	10	50	2.520	8	7.00	120
NL453232T-101K-S	100	10	40	0.796	8	8.00	110
NL453232T-121K-S	120	10	40	0.796	6	8.00	110
NL453232T-151K-S	150	10	40	0.796	5	9.00	105
NL453232T-181K-S	180	10	40	0.796	5	9.50	102
NL453232T-221K-S	220	10	40	0.796	4	12.00	100
NL453232T-271K-S	270	10	30	0.796	4	18.00	92
NL453232T-331K-S	330	10	30	0.796	3.5	20.00	85
NL453232T-391K-S	390	10	30	0.796	3	23.00	80
NL453232T-471K-S	470	10	30	0.796	3	26.00	62
NL453232T-561K-S	560	10	30	0.796	3	30.00	50
NL453232T-681K-S	680	10	30	0.796	3	40.00	50
NL453232T-821K-S	820	10	30	0.796	2.5	45.00	30
NL453232T-102K-S	1000	10	30	0.796	2.5	50.00	30



SHAPES AND DIMENSIONS NL565050 SERIES

Dimensions : mm

Shapes and Dimensions / Recommended PC Board Patterns

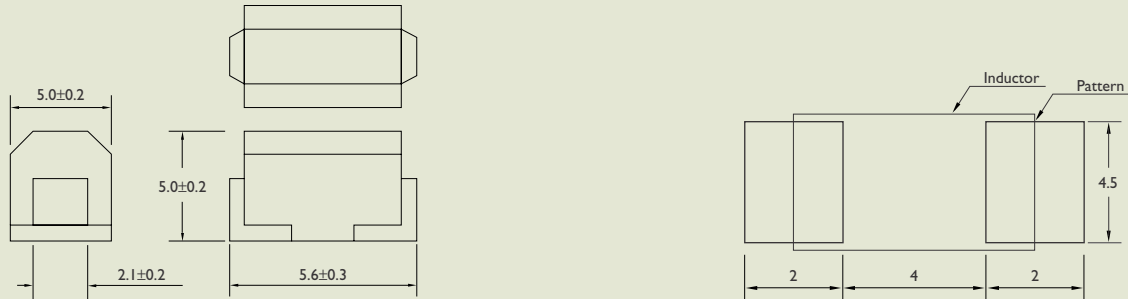

ELECTRICAL CHARACTERISTICS

Dimensions : mm

PART NO.	INDUCTANCE (mH)	TOLERANCE (±%)	Q Min.	TEST FREQUENCY (MHz)	SRF (MHz) Min.	DC RESISTANCE (Ω) Max.	IDC (mA) Max.
NL565050T-122J-S	1.2	5, 10	30	0.252	1.5	17	75
NL565050T-152J-S	1.5	5, 10	30	0.252	1.4	20	70
NL565050T-182J-S	1.8	5, 10	30	0.252	1.3	30	60
NL565050T-222J-S	2.2	5, 10	30	0.252	1.2	35	55
NL565050T-272J-S	2.7	5, 10	30	0.252	1.1	55	45
NL565050T-332J-S	3.3	5, 10	30	0.252	1	60	40
NL565050T-392J-S	3.9	5, 10	30	0.252	1	70	38
NL565050T-472J-S	4.7	5, 10	30	0.252	0.9	78	36
NL565050T-562J-S	5.6	5, 10	30	0.252	0.8	85	33
NL565050T-682J-S	6.8	5, 10	30	0.252	0.7	110	30
NL565050T-822J-S	8.2	5, 10	30	0.252	0.6	125	28
NL565050T-103J-S	10	5, 10	20	0.0796	0.5	150	25

Test Instruments : HP4286A RF Impedance Analyzer for L, Q, SRF
 HP4285A Precision LCR Meter for L, Q

Digital Multimeter SC-7401 for RDC
 Chen-Hwa 1061+Chen-Wha 301A for IDC



SHAPES AND DIMENSIONS NL201614 SERIES

Dimensions : mm

Ferrite body and wire wound construction provide highest current.

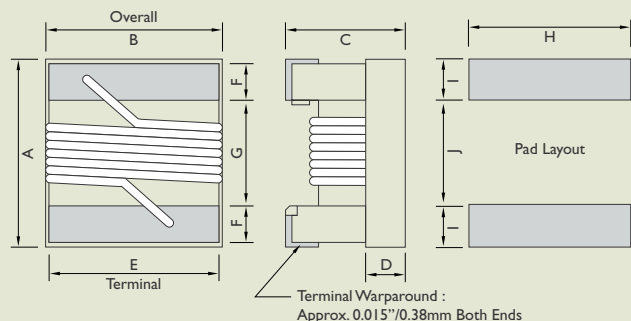

UNIT	A	B	C	D	E	F	G	H	I	J
	Max.	Max.	Max.	Ref.						
in	0.09	0.068	0.06	0.02	0.05	0.02	0.04	0.07	0.04	0.03
mm	2.29	1.73	1.52	0.51	1.27	0.51	1.02	1.78	1.02	0.76

ELECTRICAL CHARACTERISTICS

PART NO.	INDUCTANCE (μ H)	TOLERANCE (\pm %)	Q Min.	TEST FREQUENCY (MHz)	SRF (MHz) Min.	DC RESISTANCE (Ω) Max.	RATED CURRENT (mA) Max.	COLOR CODING
NL201614T-R12□-S	0.12	10/5	25	25.2	500	0.20	600	White
NL201614T-R15□-S	0.15	10/5	25	25.2	450	0.25	600	Black
NL201614T-R18□-S	0.18	10/5	25	25.2	410	0.30	570	Brown
NL201614T-R22□-S	0.22	10/5	25	25.2	350	0.35	550	Red
NL201614T-R27□-S	0.27	10/5	25	25.2	280	0.40	530	Orange
NL201614T-R33□-S	0.33	10/5	25	25.2	235	0.45	510	Yellow
NL201614T-R39□-S	0.39	10/5	25	25.2	210	0.50	490	Green
NL201614T-R47□-S	0.47	10/5	25	25.2	170	0.55	470	Blue
NL201614T-R56□-S	0.56	10/5	25	25.2	150	0.60	450	Violet
NL201614T-R68□-S	0.68	10/5	25	25.2	140	0.70	420	Gray
NL201614T-R82□-S	0.82	10/5	25	25.2	130	0.75	400	White
NL201614T-1R0□-S	1.00	10/5	15	7.96	115	0.80	350	Black
NL201614T-1R2□-S	1.20	10/5	15	7.96	95	0.90	325	Brown
NL201614T-1R5□-S	1.50	10/5	15	7.96	85	1.05	300	Red
NL201614T-1R8□-S	1.80	10/5	15	7.96	80	1.20	270	Orange
NL201614T-2R2□-S	2.20	10/5	15	7.96	75	1.40	250	Yellow
NL201614T-2R7□-S	2.70	10/5	15	7.96	70	1.60	230	Green
NL201614T-3R3□-S	3.30	10/5	15	7.96	60	1.80	210	Blue
NL201614T-3R9□-S	3.90	10/5	15	7.96	55	2.00	190	Violet
NL201614T-4R7□-S	4.70	10/5	15	7.96	45	2.40	170	Gray
NL201614T-5R6□-S	5.60	10/5	15	7.96	40	2.70	150	White
NL201614T-6R8□-S	6.80	10/5	15	7.96	36	3.20	140	Black
NL201614T-8R2□-S	8.20	10/5	15	7.96	33	3.60	120	Brown
NL201614T-100□-S	10.0	10/5	15	2.52	30	4.50	110	Red
NL201614T-120□-S	12.0	10/5	15	2.52	25	5.70	105	Orange
NL201614T-150□-S	15.0	10/5	15	2.52	33	6.50	90	Yellow
NL201614T-180□-S	18.0	10/5	15	2.52	21	7.00	85	Green
NL201614T-220□-S	22.0	10/5	15	2.52	20	8.00	78	Blue
NL201614T-270□-S	27.0	10/5	15	2.52	18	9.00	75	Violet
NL201614T-330□-S	33.0	10/5	15	2.52	17	10.0	70	Gray

When ordering, please specify tolerance and packaging code. Ex : NL201614T-100J-S

Tolerance : J = \pm 5% , K= \pm 10%

Packaging : Clear Tape and Reel (Standard)

L, Q, RDC : HP4286A

RDC : Digital Multimeter SC-7401

SRF : HP8753D / HP4286A

Operating Temperature Range : -25°C to +85°C



SHAPES AND DIMENSIONS NL252018 SERIES

Dimensions : mm

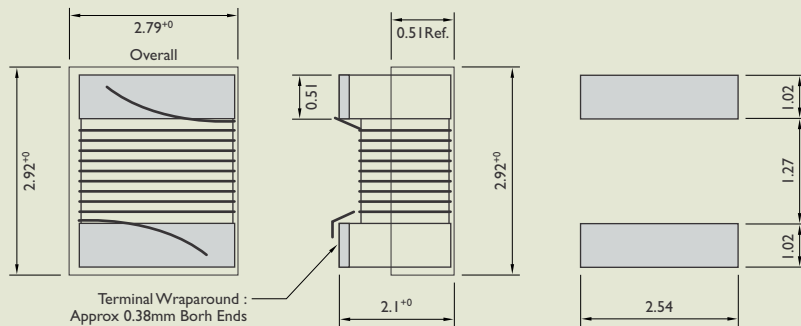

Color Coding

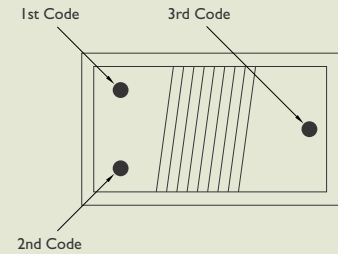

ELECTRICAL CHARACTERISTICS

PART NO.	INDUCTANCE (μ H)	TOLERANCE (\pm %)	Q Min.	TEST FREQUENCY (MHz)	SRF (MHz) Min.	DC RESISTANCE (Ω) Max.	IDC (mA) Max.	COLOR CODING		
								1 st	2 nd	3 rd
NL252018T-5N0□-S	0.005	10	10	100	3000	0.25	2000	Black	Green	Black
NL252018T-10N□-S	0.010	10	10	100	2500	0.25	1800	Brown	Black	Black
NL252018T-12N□-S	0.012	10	15	100	2400	0.26	1700	Brown	Red	Black
NL252018T-15N□-S	0.015	10	15	100	2300	0.28	1600	Brown	Green	Black
NL252018T-18N□-S	0.018	10	15	100	2200	0.30	1550	Brown	Gray	Black
NL252018T-22N□-S	0.022	5, 10	20	100	2100	0.35	1500	Red	Red	Black
NL252018T-27N□-S	0.027	5, 10	20	100	2000	0.40	1450	Red	Violet	Black
NL252018T-33N□-S	0.033	5, 10	30	100	1600	0.42	1400	Orange	Orange	Black
NL252018T-39N□-S	0.039	5, 10	35	100	1500	0.45	1350	Orange	White	Black
NL252018T-47N□-S	0.047	5, 10	35	100	1400	0.50	1300	Yellow	Violet	Black
NL252018T-56N□-S	0.056	5, 10	35	100	1300	0.60	1250	Green	Blue	Black
NL252018T-68N□-S	0.068	5, 10	35	100	1200	0.65	1240	Blue	Gray	Black
NL252018T-82N□-S	0.082	5, 10	35	100	1100	0.75	1230	Gray	Red	Black
NL252018T-R10□-S	0.10	5, 10	35	100	800	0.80	1220	Brown	Black	Brown
NL252018T-R12□-S	0.12	5, 10	30	25.2	700	0.30	900	Brown	Red	Brown
NL252018T-R15□-S	0.15	5, 10	30	25.2	550	0.35	900	Brown	Green	Brown
NL252018T-R18□-S	0.18	5, 10	30	25.2	500	0.40	850	Brown	Gray	Brown
NL252018T-R22□-S	0.22	5, 10	30	25.2	450	0.50	840	Red	Red	Brown
NL252018T-R27□-S	0.27	5, 10	30	25.2	425	0.55	830	Red	Violet	Brown
NL252018T-R33□-S	0.33	5, 10	30	25.2	400	0.60	820	Orange	Orange	Brown
NL252018T-R39□-S	0.39	5, 10	30	25.2	375	0.65	810	Orange	White	Brown
NL252018T-R47□-S	0.47	5, 10	30	25.2	350	0.68	800	Yellow	Violet	Brown



ELECTRICAL CHARACTERISTICS

PART NO.	INDUCTANCE (μ H)	TOLERANCE (\pm %)	Q Min.	TEST FREQUENCY (MHz)	SRF (MHz) Min.	DC RESISTANCE (Ω) Max.	IDC (mA) Max.	COLOR CODING		
								1 ST	2 ND	3 RD
NL252018T-R56□-S	0.560	5, 10	30	25.2	325	0.75	800	Green	Blue	Brown
NL252018T-R68□-S	0.680	5, 10	30	25.2	300	0.85	800	Blue	Gray	Brown
NL252018T-R82□-S	0.820	5, 10	30	25.2	260	1.0	800	Gray	Red	Brown
NL252018T-1R0□-S	1.000	5, 10	25	7.96	245	1.1	800	Brown	Black	Red
NL252018T-1R2□-S	1.200	5, 10	25	7.96	230	1.2	790	Brown	Red	Red
NL252018T-1R5□-S	1.500	5, 10	25	7.96	182	1.3	750	Brown	Green	Red
NL252018T-1R8□-S	1.800	5, 10	25	7.96	135	1.45	750	Brown	Gray	Red
NL252018T-2R2□-S	2.200	5, 10	25	7.96	105	1.55	750	Red	Red	Red
NL252018T-2R7□-S	2.700	5, 10	25	7.96	70	1.7	740	Red	Violet	Red
NL252018T-3R3□-S	3.300	5, 10	25	7.96	55	1.9	730	Orange	Orange	Red
NL252018T-3R9□-S	3.900	5, 10	25	7.96	48	2.1	700	Orange	White	Red
NL252018T-4R7□-S	4.7	5, 10	25	7.96	43	2.3	650	Yellow	Violet	Red
NL252018T-5R6□-S	5.6	5, 10	20	7.96	42	2.5	640	Green	Blue	Red
NL252018T-6R8□-S	6.8	5, 10	20	7.96	39	2.7	630	Blue	Gray	Red
NL252018T-8R2□-S	8.2	5, 10	20	7.96	36	3.05	600	Gray	Red	Red
NL252018T-100□-S	10	5, 10	15	2.52	33	3.5	680	Brown	Black	Orange
NL252018T-120□-S	12	5, 10	15	2.52	30	3.8	650	Brown	Red	Orange
NL252018T-150□-S	15	5, 10	15	2.52	26	4.4	500	Brown	Green	Orange
NL252018T-180□-S	18	5, 10	15	2.52	24	4.8	450	Brown	Gray	Orange
NL252018T-220□-S	22	5, 10	15	2.52	22	5.5	450	Red	Red	Orange
NL252018T-270□-S	27	5, 10	15	2.52	21	6.3	430	Red	Violet	Orange
NL252018T-330□-S	33	5, 10	15	2.52	20	7.1	380	Orange	Orange	Orange
NL252018T-390□-S	39	5, 10	10	2.52	18	9.5	330	Orange	White	Orange
NL252018T-470□-S	47	5, 10	10	2.52	17	11.1	300	Yellow	Violet	Orange
NL252018T-560□-S	56	5, 10	10	2.52	16	12.1	270	Green	Blue	Orange
NL252018T-680□-S	68	5, 10	10	2.52	15	16.6	250	Blue	Gray	Orange
NL252018T-820□-S	82	5, 10	10	2.52	13	19	200	Gray	Red	Orange
NL252018T-101□-S	100	5, 10	8	0.796	12	21	120	Brown	Black	Yellow

* UV Color : Blue / Core Color : Black

When ordering, please specify tolerance and packaging code. Ex : NL252018T-101J-S

Tolerance : □ J = 5% □ K = 10%

Packaging : Clear Tape and Reel (Standard)

L, Q, RDC : HP4287A

SRF : HP8753D / HP4291A RDC : Digital Multimeter SC-7401

Operating Temperature Range : -25°C to +85°C



TAPE DIMENSIONS

Dimensions : mm

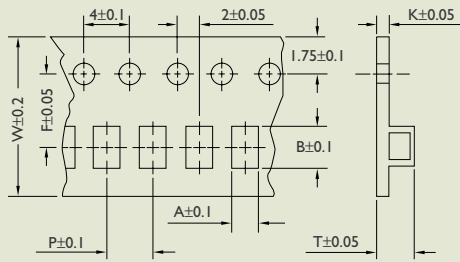

TYPE	A	B	T	W	P	F	K
NL201614	1.88	2.38	1.48	8	4	3.5	0.2
NL252018	2.61	2.83	2.25	8	4	3.5	0.25
NL322522	2.94	3.64	2.52	8	4	3.5	0.2
NL453232	3.64	5.14	3.6	12	8	5.5	0.3
NL565050	4.9	5.65	5.3	16.15	12.2	5.5	0.5

TAPE MATERIAL

Carrier Tape : Polystyrene

Cover Tape : Polyethylene

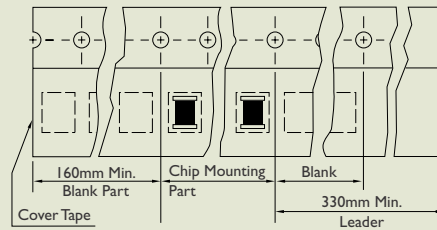

REEL DIMENSIONS

Dimensions : mm

Figure 1

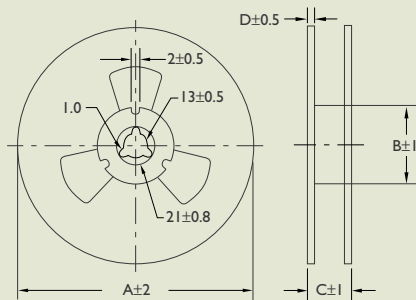
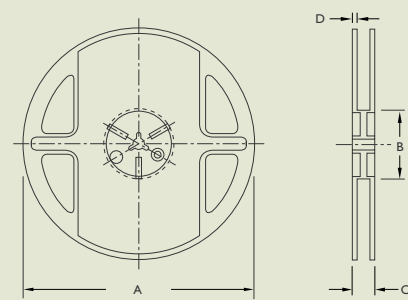

Figure 2



TYPE	FIGURE	A	B	C	D
NL201614	2	178	60	13	9
NL252018	2	178	60	12	1.5
NL322522	1	178	60	10	1.5
NL453232	1	250	80	14	1.5
NL565050	2	330	80	20	2

RECOMMENDED PATTERN

Dimensions : mm

NL45

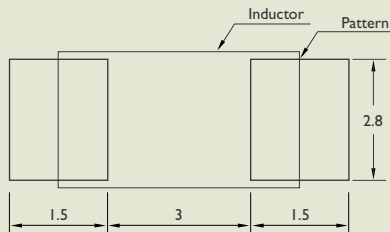

PACKAGING QUANTITY

TYPE	BULK	QUANTITY/REEL
NL201614	√	2500
NL252018	√	2000
NL322522	√	2000
NL453232	√	500
NL565050	√	1000



TYPICAL ELECTRICAL CHARACTERISTICS

Test Instruments : HP4291A Impedance / Material Analyzer

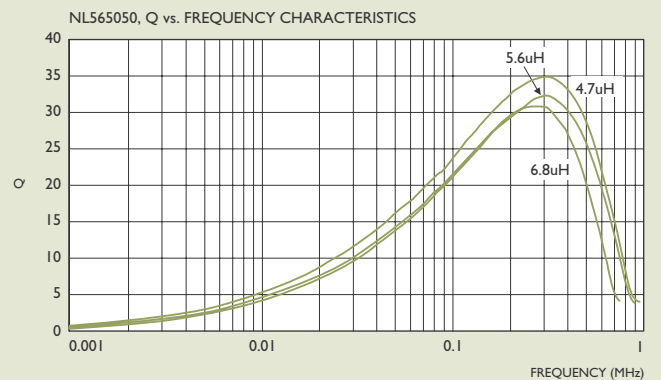
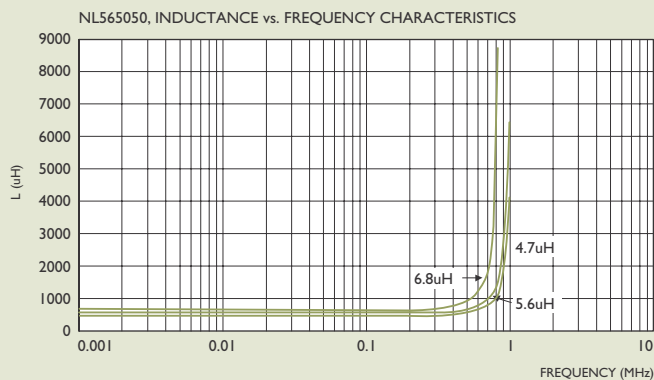
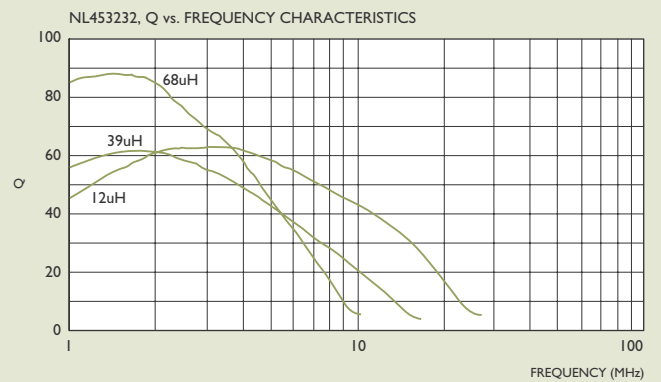
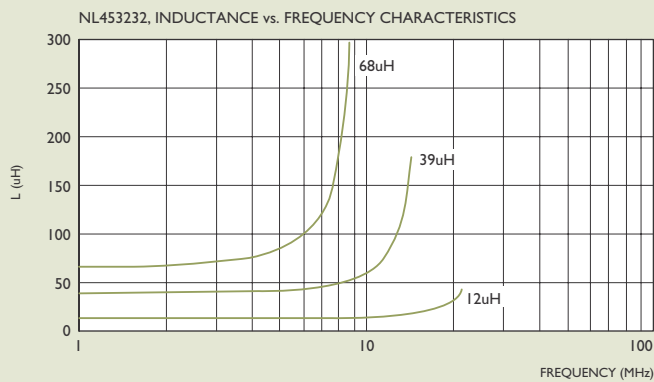
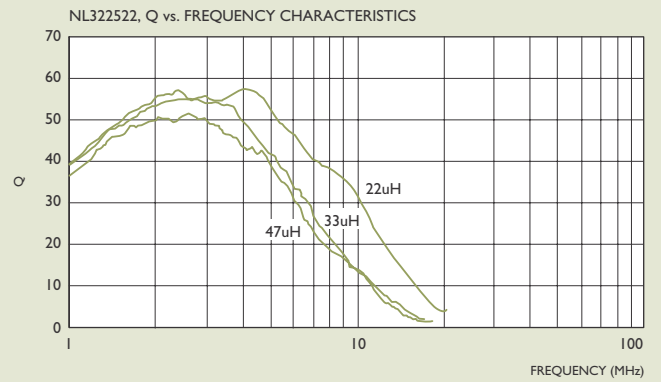
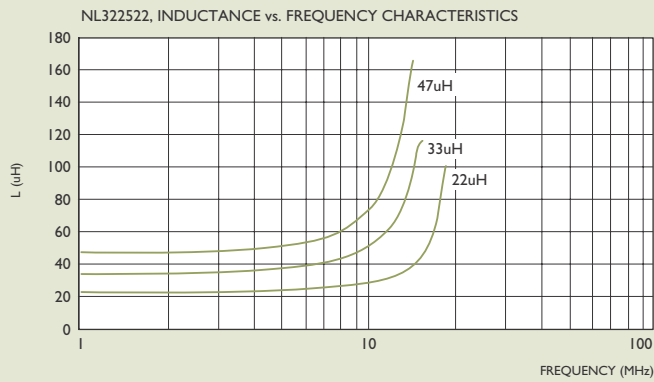
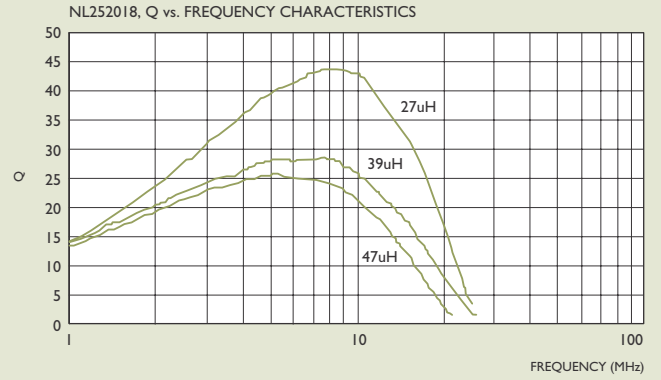
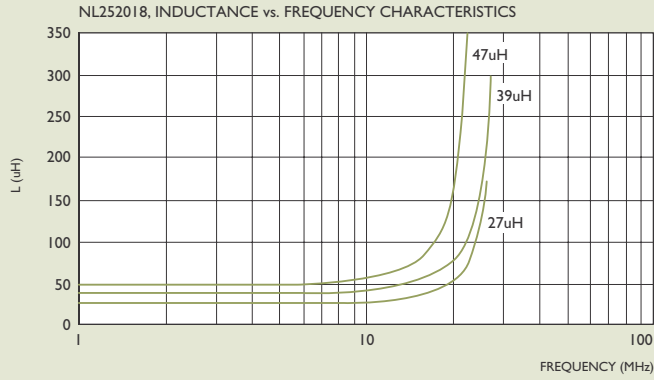



NL SERIES RELIABILITY TEST

I-1 MECHANICAL PERFORMANCE

NO.	ITEM	SPECIFICATION	TEST CONDITIONS
I-1-1	Vibration	Appearance : No Damage L Change : within $\pm 10\%$ Q Change : within $\pm 30\%$	Test device shall be soldered on the substrate. Oscillation Frequency : 10 to 55 to 10Hz for 1Min. Amplitude : 1.5mm Time : 2Hrs. for each Axis (X, Y & Z), Total 6Hrs.
I-1-2	Resistance to Soldering Heat	Appearance : No Damage	Pre-heating : 150°C, 1Min. Solder Composition : Sn/Pb = 63/37 Solder Temperature : $260 \pm 5^\circ\text{C}$ Immersion Time : 10 ± 1 Sec.
I-1-3	Solderability	The electrodes shall be at least 90% covered with new solder coating.	Pre-heating : 150°C, 1Min. Solder Composition : Sn/Pb = 63/37 Solder Temperature : $230 \pm 5^\circ\text{C}$ Immersion Time : 4 ± 1 Sec.

I-2 ENVIRONMENTAL PERFORMANCE

NO.	ITEM	SPECIFICATION	TEST CONDITIONS															
I-2-1	Temperature Cycle	Appearance : No Damage L Change : within $\pm 10\%$ Q Change : within $\pm 30\%$	One Cycle <table border="1"> <thead> <tr> <th>Step</th> <th>Temperature ($^\circ\text{C}$)</th> <th>Time (Min.)</th> </tr> </thead> <tbody> <tr> <td>1</td> <td>-25 ± 3</td> <td>30</td> </tr> <tr> <td>2</td> <td>25 ± 2</td> <td>3</td> </tr> <tr> <td>3</td> <td>85 ± 3</td> <td>30</td> </tr> <tr> <td>4</td> <td>25 ± 2</td> <td>3</td> </tr> </tbody> </table> Total : 100 Cycles Measured after Exposure in the Room Condition for 24Hrs.	Step	Temperature ($^\circ\text{C}$)	Time (Min.)	1	-25 ± 3	30	2	25 ± 2	3	3	85 ± 3	30	4	25 ± 2	3
Step	Temperature ($^\circ\text{C}$)	Time (Min.)																
1	-25 ± 3	30																
2	25 ± 2	3																
3	85 ± 3	30																
4	25 ± 2	3																
I-2-2	Humidity Resistance		Temperature : $40 \pm 2^\circ\text{C}$ Relative Humidity : 90 ~ 95% Time : 1000Hrs. Measured after Exposure in the Room Condition for 24Hrs.															
I-2-3	High Temperature Resistance		Temperature : $85 \pm 3^\circ\text{C}$ Relative Humidity : 20% Applied Current : Rated Current Time : 1000Hrs. Measured after Exposure in the Room Condition for 24Hrs.															
I-2-4	Low Temperature Resistance		Temperature : $-25 \pm 3^\circ\text{C}$ Relative Humidity : 0% Time : 1000Hrs. Measured after Exposure in the Room Condition for 24Hrs.															

Wound Chip Inductors

NLC Series

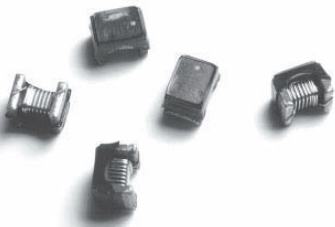

These revolutionary, highly reliable wound chip inductors for automatic mounting have been developed in response to the trend toward high density in electronic equipment.

With metal terminals and a body of heat resistant resin, these inductors offer many superior features.

PRODUCT IDENTIFICATION

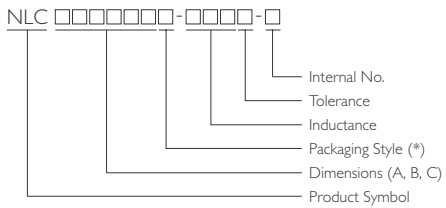

* T: Tape and Reel ; B: Bulk



SHAPES AND DIMENSIONS NLC252018 SERIES

Dimensions : mm

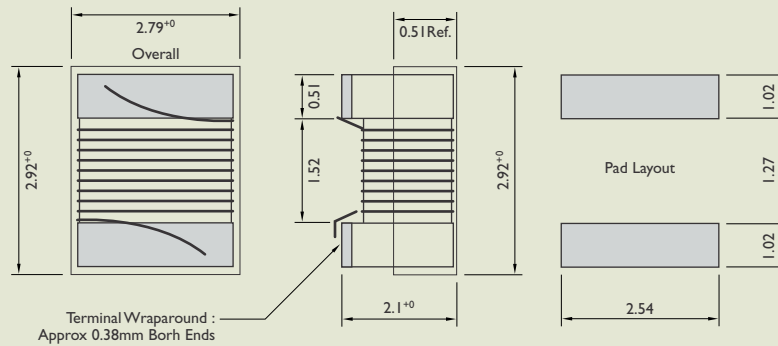

ELECTRICAL CHARACTERISTICS

PART NO.	INDUCTANCE (μH)	TOLERANCE ($\pm\%$)	Q Min.	TEST FREQUENCY (MHz)	SRF (MHz) Min.	DC RESISTANCE (Ω) Max.	IDC (mA) Max.	COLOR CODING		
NLC252018T-1R0□-S	1.0	20	25	7.96	300	0.34	1400	Brown	Black	Red
NLC252018T-1R5□-S	1.5	20	25	7.96	270	0.42	1300	Brown	Green	Red
NLC252018T-2R2□-S	2.2	20	25	7.96	140	0.50	1300	Red	Red	Red
NLC252018T-3R3□-S	3.3	20	25	7.96	95	0.65	800	Orange	Orange	Red
NLC252018T-4R7□-S	4.7	20	25	7.96	90	0.80	800	Yellow	Violet	Red
NLC252018T-6R8□-S	6.8	20	25	7.96	68	1.00	650	Blue	Gray	Red
NLC252018T-100□-S	10	10	20	2.52	45	1.50	600	Brown	Black	Orange
NLC252018T-150□-S	15	10	20	2.52	40	2.20	450	Brown	Green	Orange
NLC252018T-220□-S	22	10	20	2.52	25	2.70	380	Red	Red	Orange
NLC252018T-330□-S	33	10	20	2.52	25	4.00	350	Orange	Orange	Orange
NLC252018T-470□-S	47	10	16	2.52	20	8.00	300	Orange	Orange	Orange

When ordering, please specify tolerance and packaging code. Ex : NLC252018T-6R8J-S

Tolerance : J = 5%

K = 10%

Packaging : Clear Tape and Reel (Standard)

L, Q : HP4287A

SRF : HP8753D / HP4291A

RDC : Digital Multimeter SC-7401

Operating Temperature Range : -25°C to +85°C



SHAPES AND DIMENSIONS NLC322522 SERIES

Dimensions : mm

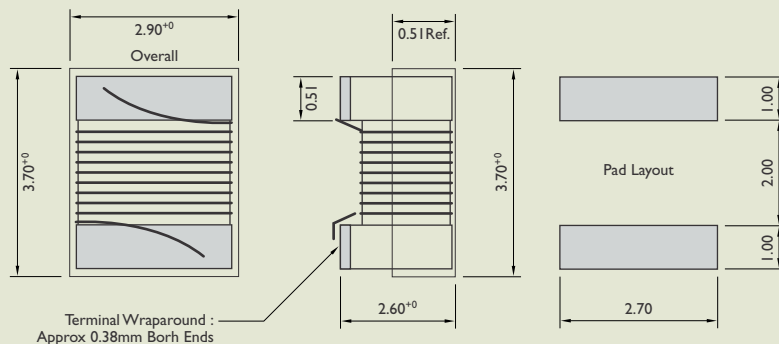

ELECTRICAL CHARACTERISTICS

PART NO.	INDUCTANCE (μ H)	TOLERANCE (\pm %)	Q Min.	TEST FREQUENCY (MHz)	SRF (MHz) Min.	DC RESISTANCE (Ω) Max.	IDC (mA) Max.	COLOR CODING		
NLC322522T-1R0□-S	1.0	5, 10	20	7.96	100	0.08	1500	Brown	Black	Red
NLC322522T-1R5□-S	1.5	5, 10	20	7.96	80	0.13	1125	Brown	Green	Red
NLC322522T-2R2□-S	2.2	5, 10	20	7.96	68	0.13	970	Red	Red	Red
NLC322522T-3R3□-S	3.3	5, 10	20	7.96	54	0.16	837	Orange	Orange	Red
NLC322522T-4R7□-S	4.7	5, 10	20	7.96	43	0.20	675	Yellow	Violet	Red
NLC322522T-6R8□-S	6.8	5, 10	20	7.96	33	0.27	600	Blue	Gray	Red
NLC322522T-100□-S	10	5, 10	15	2.52	28	0.36	520	Brown	Green	Orange
NLC322522T-150□-S	15	5, 10	15	2.52	19	0.56	480	Brown	Green	Orange
NLC322522T-220□-S	22	5, 10	15	2.52	16	0.77	310	Red	Red	Orange
NLC322522T-330□-S	33	5, 10	15	2.52	12	1.10	270	Orange	Orange	Orange
NLC322522T-470□-S	47	5, 10	15	2.52	10	1.64	210	Yellow	Violet	Orange
NLC322522T-680□-S	68	5, 10	15	2.52	9	2.80	189	Blue	Gray	Orange
NLC322522T-101□-S	100	5, 10	15	0.796	6	3.70	145	Brown	Black	Yellow
NLC322522T-151□-S	150	5, 10	15	0.796	5	6.10	120	Brown	Green	Yellow
NLC322522T-221□-S	220	5, 10	15	0.796	4	8.40	100	Red	Red	Yellow
NLC322522T-331□-S	330	5, 10	15	0.796	3.5	12.3	80	Orange	Orange	Yellow
NLC322522T-471□-S	470	5, 10	15	0.796	2.8	22.0	75	Yellow	Violet	Yellow
NLC322522T-681□-S	680	5, 10	15	0.796	2	28.0	65	Blue	Gray	Yellow

When ordering, please specify tolerance and packaging code. Ex : NLC322522T-101J-S

Tolerance : J = 5%

K = 10%

Packaging : Clear Tape and Reel (Standard)

L, Q : HP4287A

SRF : HP8753D / HP4291A

RDC : Digital Multimeter SC-7401

Operating Temperature Range : -25°C to +85°C



SHAPES AND DIMENSIONS NLC453232 SERIES

Dimensions : mm

Shapes and Dimensions / Recommended PC Board Patterns

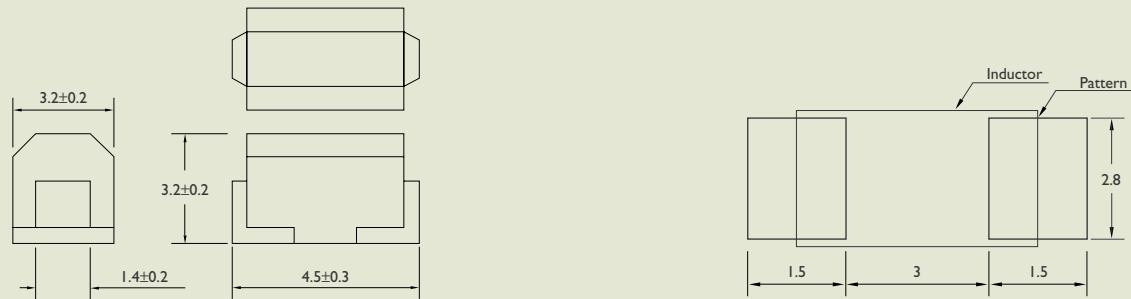

ELECTRICAL CHARACTERISTICS

Dimensions : mm

PART NO.	INDUCTANCE (μH)	TOLERANCE ($\pm\%$)	Q Min.	TEST FREQUENCY (MHz)	SRF (MHz) Min.	DC RESISTANCE (Ω) Max.	IDC (mA) Max.
NLC453232T-1R0K-S	1.0	10	10	7.96	200	0.11	1050
NLC453232T-1R2K-S	1.2	10	10	7.96	155	0.12	1000
NLC453232T-1R5K-S	1.5	10	10	7.96	130	0.15	950
NLC453232T-1R8K-S	1.8	10	10	7.96	100	0.16	900
NLC453232T-2R2K-S	2.2	10	10	7.96	80	0.18	850
NLC453232T-2R7K-S	2.7	10	10	7.96	55	0.20	800
NLC453232T-3R3K-S	3.3	10	10	7.96	45	0.22	750
NLC453232T-3R9K-S	3.9	10	10	7.96	40	0.24	700
NLC453232T-4R7K-S	4.7	10	10	7.96	35	0.27	650
NLC453232T-5R6K-S	5.6	10	10	7.96	30	0.30	650
NLC453232T-6R8K-S	6.8	10	10	7.96	28	0.35	600
NLC453232T-8R2K-S	8.2	10	10	7.96	25	0.40	600
NLC453232T-100K-S	10	10	10	2.52	22	0.50	550
NLC453232T-120K-S	12	10	10	2.52	21	0.60	500
NLC453232T-150K-S	15	10	10	2.52	20	0.70	450
NLC453232T-180K-S	18	10	10	2.52	18	0.80	400
NLC453232T-220K-S	22	10	10	2.52	17	0.90	370
NLC453232T-270K-S	27	10	10	2.52	15	1.20	330
NLC453232T-330K-S	33	10	10	2.52	14	1.40	300
NLC453232T-390K-S	39	10	10	2.52	12	1.60	280
NLC453232T-470K-S	47	10	10	2.52	11.5	1.90	260
NLC453232T-560K-S	56	10	10	2.52	10.5	2.20	240
NLC453232T-680K-S	68	10	10	2.52	9	2.60	220
NLC453232T-820K-S	82	10	10	2.52	8.5	3.50	200
NLC453232T-101K-S	100	10	20	0.796	7.0	4.00	180
NLC453232T-121K-S	120	10	20	0.796	6.5	4.50	160
NLC453232T-151K-S	150	10	20	0.796	6	6.50	140
NLC453232T-181K-S	180	10	20	0.796	5.5	7.50	120
NLC453232T-221K-S	220	10	20	0.796	5.0	9.00	120
NLC453232T-271K-S	270	10	20	0.796	4.5	11.0	100
NLC453232T-331K-S	330	10	20	0.796	4	13.0	90

Test Instruments : HP4286A RF Impedance Analyzer for L, Q, SRF
HP4285A LF Impedance Analyzer for L, Q

Digital Multimeter SC-7401 for RDC
Chen-Hwa 1061+Chen-Wha 301A for IDC



SHAPES AND DIMENSIONS NLC565050 SERIES

Dimensions : mm

Shapes and Dimensions / Recommended PC Board Patterns

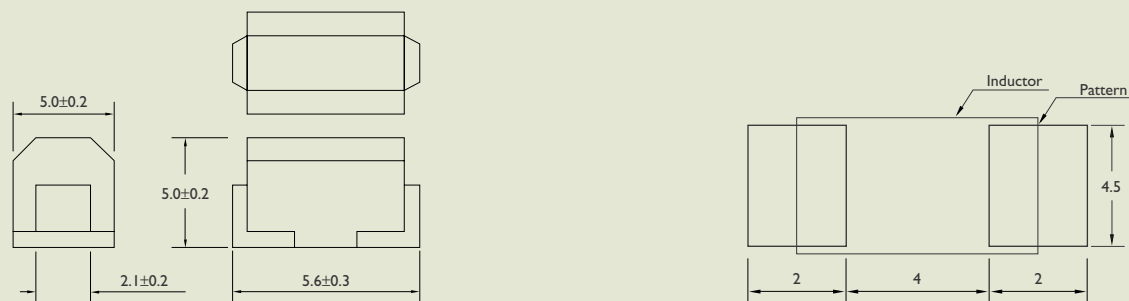

ELECTRICAL CHARACTERISTICS

PART NO.	INDUCTANCE (μ H)	TOLERANCE (\pm %)	Q Min.	TEST FREQUENCY (MHz)	SRF (MHz) Min.	DC RESISTANCE (Ω) Max.	IDC (mA) Max.
NLC565050T-1R0K-S	1.0	10	10	7.96	95	0.03	1800
NLC565050T-1R2K-S	1.2	10	10	7.96	70	0.035	1700
NLC565050T-1R5K-S	1.5	10	10	7.96	55	0.04	1600
NLC565050T-1R8K-S	1.8	10	10	7.96	47	0.05	1400
NLC565050T-2R2K-S	2.2	10	10	7.96	42	0.06	1300
NLC565050T-2R7K-S	2.7	10	10	7.96	37	0.07	1200
NLC565050T-3R3K-S	3.3	10	10	7.96	34	0.08	1120
NLC565050T-3R9K-S	3.9	10	10	7.96	32	0.09	1050
NLC565050T-4R7K-S	4.7	10	10	7.96	29	0.11	950
NLC565050T-5R6K-S	5.6	10	10	7.96	26	0.13	880
NLC565050T-6R8K-S	6.8	10	10	7.96	24	0.15	810
NLC565050T-8R2K-S	8.2	10	10	7.96	22	0.18	750
NLC565050T-100K-S	10	10	10	2.52	19	0.21	690
NLC565050T-120K-S	12	10	10	2.52	17	0.25	630
NLC565050T-150K-S	15	10	10	2.52	16	0.30	580
NLC565050T-180K-S	18	10	10	2.52	14	0.36	530
NLC565050T-220K-S	22	10	10	2.52	13	0.43	480
NLC565050T-270K-S	27	10	10	2.52	11.5	0.52	440
NLC565050T-330K-S	33	10	10	2.52	10.5	0.62	400
NLC565050T-390K-S	39	10	10	2.52	9.5	0.72	370
NLC565050T-470K-S	47	10	10	2.52	8.5	0.85	340
NLC565050T-560K-S	56	10	10	2.52	7.8	1.00	310
NLC565050T-680K-S	68	10	10	2.52	7	1.2	290
NLC565050T-820K-S	82	10	10	2.52	6.4	1.4	270
NLC565050T-101K-S	100	10	20	0.796	6	1.6	250
NLC565050T-121K-S	120	10	20	0.796	5.4	1.9	230
NLC565050T-151K-S	150	10	20	0.796	4.8	2.2	210
NLC565050T-181K-S	180	10	20	0.796	4.4	2.8	190
NLC565050T-221K-S	220	10	20	0.796	3.9	3.4	170
NLC565050T-271K-S	270	10	20	0.796	3.6	4.2	155
NLC565050T-331K-S	330	10	20	0.796	3.2	4.9	140
NLC565050T-391K-S	390	10	20	0.796	2.9	5.8	130
NLC565050T-471K-S	470	10	20	0.796	2.6	7	120
NLC565050T-561K-S	560	10	20	0.796	2.4	8.5	110
NLC565050T-681K-S	680	10	20	0.796	2.2	10	100
NLC565050T-821K-S	820	10	20	0.796	2	13	90
NLC565050T-102K-S	1000	10	20	0.252	1.8	15	85

Test Instruments : HP4286A RF Impedance Analyzer for L, Q, SRF
HP4285A LF Impedance Analyzer for L, Q

Digital Multimeter SC-7401 for RDC
Chen-Hwa 1061+Chen-Wiha 301A for IDC



TAPE DIMENSIONS

Dimensions : mm

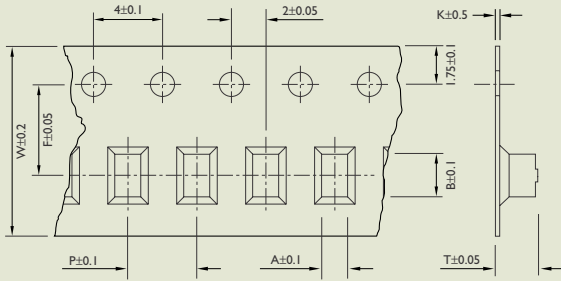

TYPE	A	B	T	W	P	F	K
NLC252018	2.61	2.83	2.25	8	4	3.5	0.25
NLC322522	2.61	2.83	2.25	8	4	3.5	0.25
NLC453232	3.64	5.14	3.6	12	8	5.5	0.3
NLC565050	4.9	5.65	5.3	16.15	12.2	5.5	0.5

REEL DIMENSIONS

Dimensions : mm

Figure 1

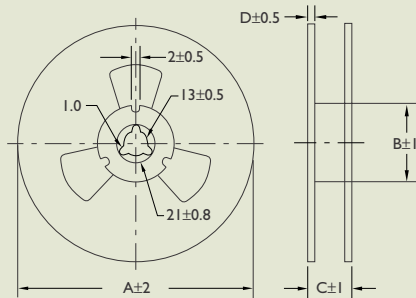
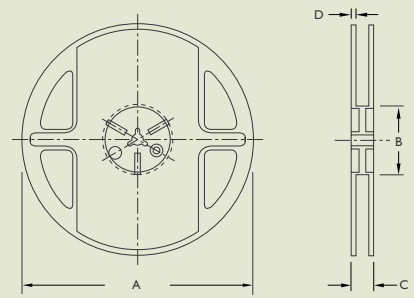

Figure 2



TYPE	FIGURE	A	B	C	D
NLC252018	2	178	60	12	1.5
NLC322522	1	178	60	10	2
NLC453232	1	250	80	14	2
NLC565050	2	330	80	20	2

TAPE MATERIAL

Carrier Tape : Polystyrene

Cover Tape : Polyethylene

PACKAGING QUANTITY

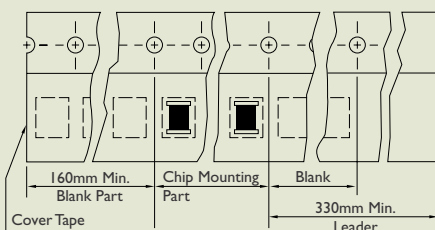

TYPE	BULK	QUANTITY/REEL
NLC252018	√	2000
NLC322522	√	2000
NLC453232	√	500
NLC565050	√	1000



TYPICAL ELECTRICAL CHARACTERISTICS

Test Instruments : HP4291A Impedance / Material Analyzer

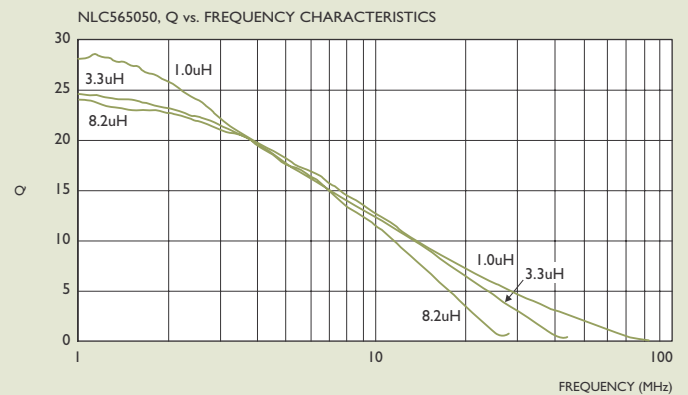
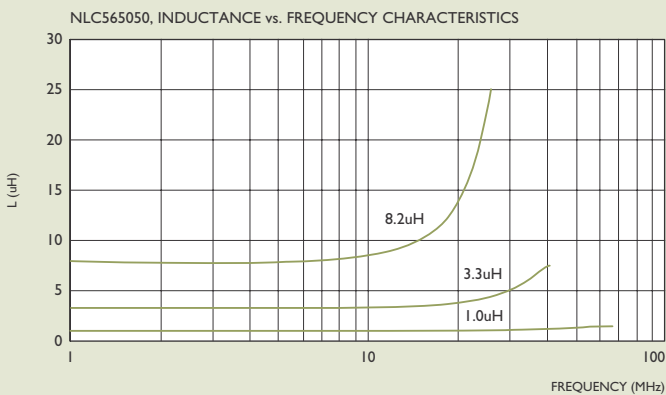
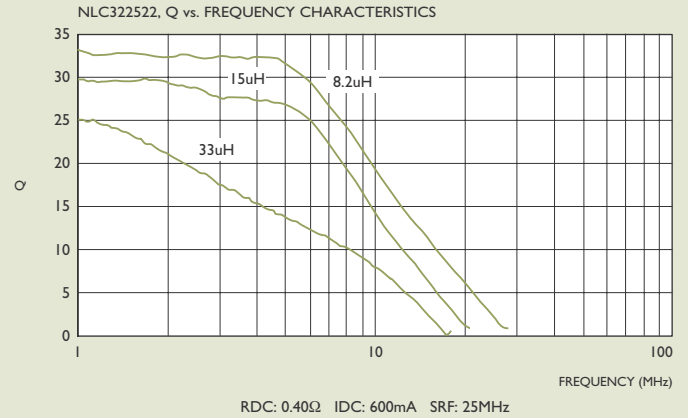
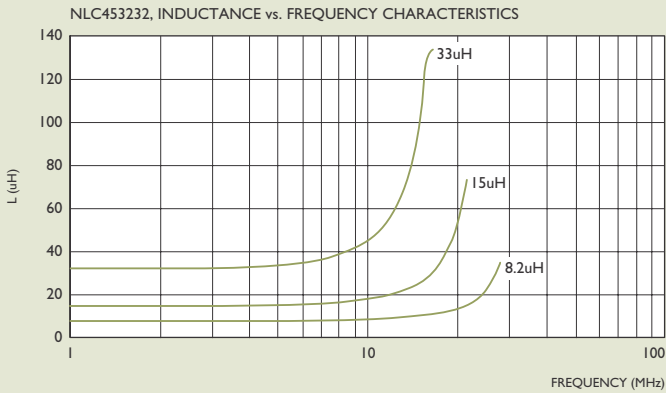
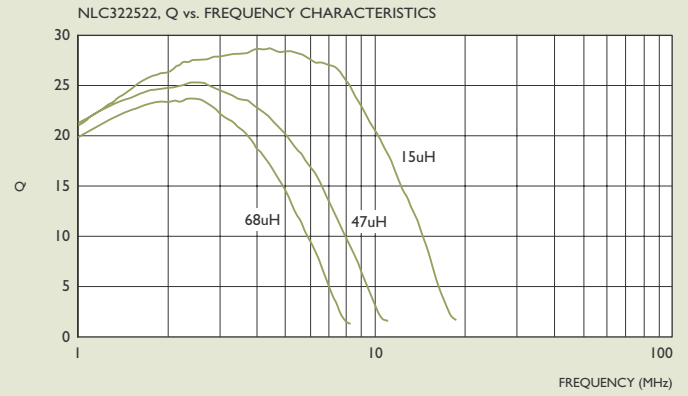
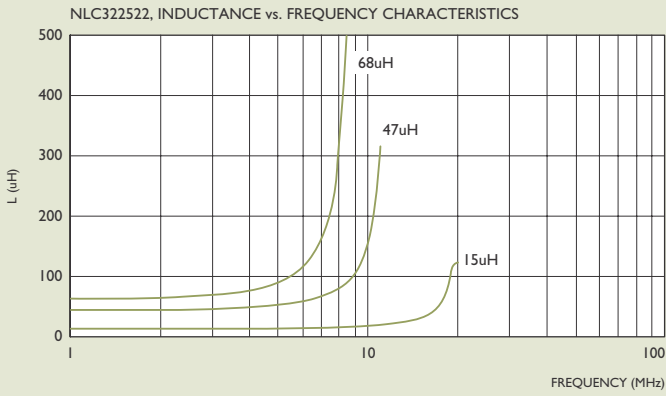



NLC SERIES RELIABILITY TEST

I-1 MECHANICAL PERFORMANCE

NO.	ITEM	SPECIFICATION	TEST CONDITIONS
I-1-1	Vibration	Appearance : No Damage L Change : within $\pm 10\%$ Q Change : within $\pm 30\%$ RDC : within Specification	Test device shall be soldered on the substrate. Oscillation Frequency : 10 to 55 to 10Hz for 1Min. Amplitude : 1.5mm Time : 2Hrs. for each Axis (X,Y & Z), Total 6Hrs.
I-1-2	Resistance to Soldering Heat	Appearance : No Damage	Pre-heating : 150°C, 1Min. Solder Composition : Sn/Pb = 63/37 Solder Temperature : $260 \pm 5^\circ\text{C}$ Immersion Time : 10 ± 1 Sec.
I-1-3	Solderability	The electrodes shall be at least 90% covered with new solder coating.	Pre-heating : 150°C, 1Min. Solder Composition : Sn/Pb = 63/37 Solder Temperature : $230 \pm 5^\circ\text{C}$ Immersion Time : 4 ± 1 Sec.

I-2 ENVIRONMENTAL PERFORMANCE

NO.	ITEM	SPECIFICATION	TEST CONDITIONS															
I-2-1	Temperature Cycle	Appearance : No Damage L Change : within $\pm 10\%$ Q Change : within $\pm 30\%$ RDC : within Specification	One Cycle <table border="1"><thead><tr><th>Step</th><th>Temperature (°C)</th><th>Time (Min.)</th></tr></thead><tbody><tr><td>1</td><td>-25 ± 3</td><td>30</td></tr><tr><td>2</td><td>25 ± 2</td><td>3</td></tr><tr><td>3</td><td>85 ± 3</td><td>30</td></tr><tr><td>4</td><td>25 ± 2</td><td>3</td></tr></tbody></table> Total : 100 Cycles Measured after Exposure in the Room Condition for 24Hrs.	Step	Temperature (°C)	Time (Min.)	1	-25 ± 3	30	2	25 ± 2	3	3	85 ± 3	30	4	25 ± 2	3
Step	Temperature (°C)	Time (Min.)																
1	-25 ± 3	30																
2	25 ± 2	3																
3	85 ± 3	30																
4	25 ± 2	3																
I-2-2	Humidity Resistance		Temperature : $40 \pm 2^\circ\text{C}$ Relative Humidity : 90 ~ 95% Time : 1000Hrs. Measured after Exposure in the Room Condition for 24Hrs.															
I-2-3	High Temperature Resistance		Temperature : $85 \pm 3^\circ\text{C}$ Relative Humidity : 20% Applied Current : Rated Current Time : 1000Hrs. Measured after Exposure in the Room Condition for 24Hrs.															
I-2-4	Low Temperature Resistance		Temperature : $-25 \pm 3^\circ\text{C}$ Relative Humidity : 0% Time : 1000Hrs. Measured after Exposure in the Room Condition for 24Hrs.															

Multilayer Chip Inductors High Frequency

CLH Series



PRODUCT IDENTIFICATION

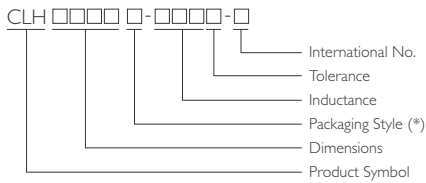

* B: Bulk ; T: Tape and Reel

APPLICATIONS

RF Resonance and Impedance Matching Circuit

RF and Wireless Communication

Information Technology Equipments, Computers, Telecommunications, Radar Detectors, Automotive Electronics, Cellular Phones, Pagers, PDAs, Keyless Remote Systems.

Use in L-C Filter Configurations

OUTLINE

Yageo high frequency multilayer ceramic chip inductor is formed without wound wire.

Monolithic laminated structure.

FEATURES

Excellent Q Factor and SRF Characteristic

Cost Effective

Small size of 1005/1608 is suitable for small portable equipment.

Supports Operating Frequency Bands up to 6GHz with Nominal Inductance Values from 1.0nH To 470nH

SHAPES AND DIMENSIONS

Dimensions : mm

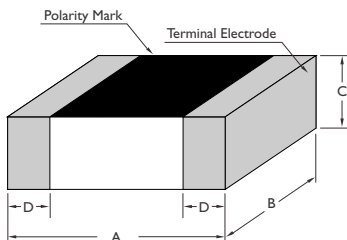

TYPE	INDUCTANCE RANGE	A	B	C	D
CLH1005	All	1.00 ± 0.10	0.50 ± 0.10	0.50 ± 0.10	0.25 ± 0.10
CLH1608	All	1.60 ± 0.15	0.80 ± 0.15	0.80 ± 0.15	0.30 ± 0.20
CLH2012	< 180nH	2.00 ± 0.20	1.25 ± 0.20	0.90 ± 0.20	0.50 ± 0.30
	≥ 180nH	2.00 ± 0.20	1.25 ± 0.20	1.20 ± 0.30	0.50 ± 0.30



ELECTRICAL CHARACTERISTICS CLH1005T (0402) SERIES

PART NO.	INDUCTANCE at 100MHz (nH)	TOLERANCE	Q Min. at 100MHz	Q TYPICAL		SRF (MHz) Min.	DC RESISTANCE (Ω) Max.	RATED CURRENT (mA) Max.
				at 100MHz	at 800MHz			
CLH1005T-1N0□-S	1.0	S	8	9	28	10,000	0.10	300
CLH1005T-1N2□-S	1.2	S	8	9	28	10,000	0.10	300
CLH1005T-1N5□-S	1.5	S	8	10	28	9,000	0.10	300
CLH1005T-1N8□-S	1.8	S	8	10	28	8,700	0.10	300
CLH1005T-2N2□-S	2.2	S	8	10	29	8,100	0.12	300
CLH1005T-2N7□-S	2.7	S	8	11	30	7,700	0.12	300
CLH1005T-3N3□-S	3.3	S, K	8	11	30	6,300	0.15	300
CLH1005T-3N9□-S	3.9	S, K	8	11	31	6,100	0.15	300
CLH1005T-4N7□-S	4.7	S, K	8	11	31	5,400	0.18	300
CLH1005T-5N6□-S	5.6	S, K	8	11	31	5,100	0.20	300
CLH1005T-6N8□-S	6.8	J, K	8	11	33	4,550	0.25	300
CLH1005T-8N2□-S	8.2	J, K	8	12	32	4,100	0.25	300
CLH1005T-10N□-S	10	J, K	8	12	32	3,900	0.30	300
CLH1005T-12N□-S	12	J, K	8	12	31	3,000	0.30	300
CLH1005T-15N□-S	15	J, K	8	12	30	2,600	0.40	300
CLH1005T-18N□-S	18	J, K	8	12	29	2,350	0.50	300
CLH1005T-22N□-S	22	J, K	8	12	28	2,000	0.60	300
CLH1005T-27N□-S	27	J, K	8	12	27	1,900	1.00	300
CLH1005T-33N□-S	33	J, K	8	10	25	1,700	1.50	200
CLH1005T-39N□-S	39	J, K	8	10	25	1,600	1.80	200
CLH1005T-47N□-S	47	J, K	8	9	22	1300	2.00	200
CLH1005T-56N□-S	56	J, K	8	10	21	1250	2.00	200
CLH1005T-68N□-S	68	J, K	8	10	15	1000	2.20	100
CLH1005T-82N□-S	82	J, K	8	9	13	900	2.50	100
CLH1005T-R10□-S	100	J, K	8	9	10	850	2.50	100

Note : Tolerance : □ – S = ±0.3nH J = ±5%

K = ±10%

Test Conditions : L/Q – Agilent E4991A

Fixture – Agilent 16197A

SRF – HP8753D

RDC – HP4338B



ELECTRICAL CHARACTERISTICS CLHI608T (0603) SERIES

PART NO.	INDUCTANCE at 100MHz (nH)	TOLERANCE	Q Min. at 100MHz	Q TYPICAL		SRF (MHz) Min.	DC RESISTANCE (Ω) Max.	RATED CURRENT (mA) Max.
				at 100MHz	at 800MHz			
CLHI608T-1N0□-S	1.0	S	10	12	60	10,000	0.10	500
CLHI608T-1N2□-S	1.2	S	10	13	60	10,000	0.10	500
CLHI608T-1N5□-S	1.5	S	10	13	57	8,000	0.10	500
CLHI608T-1N8□-S	1.8	S	10	13	51	8,000	0.10	500
CLHI608T-2N2□-S	2.2	S	11	13	46	7,200	0.10	500
CLHI608T-2N7□-S	2.7	S	11	13	46	6,200	0.10	500
CLHI608T-3N3□-S	3.3	S, K	11	13	47	5,200	0.12	500
CLHI608T-3N9□-S	3.9	S, K	11	13	47	5,000	0.14	500
CLHI608T-4N7□-S	4.7	S, K	11	13	41	4,750	0.16	500
CLHI608T-5N6□-S	5.6	S, K	11	13	41	4,100	0.18	500
CLHI608T-6N8□-S	6.8	J, K	11	13	44	3750	0.22	500
CLHI608T-8N2□-S	8.2	J, K	11	13	44	3300	0.24	500
CLHI608T-10N□-S	10	J, K	11	13	45	3,000	0.26	400
CLHI608T-12N□-S	12	J, K	13	15	46	2,600	0.28	400
CLHI608T-15N□-S	15	J, K	13	15	48	2,500	0.32	400
CLHI608T-18N□-S	18	J, K	13	15	48	2,400	0.35	400
CLHI608T-22N□-S	22	J, K	15	17	45	2,000	0.40	400
CLHI608T-27N□-S	27	J, K	15	17	43	1,900	0.45	400
CLHI608T-33N□-S	33	J, K	15	18	39	1,600	0.55	400
CLHI608T-39N□-S	39	J, K	15	18	37 *	1400	0.60	300
CLHI608T-47N□-S	47	J, K	15	18	35 *	1,300	0.70	300
CLHI608T-56N□-S	56	J, K	15	18	32 *	1100	0.75	300
CLHI608T-68N□-S	68	J, K	15	18	34 *	1050	0.85	300
CLHI608T-82N□-S	82	J, K	15	18	32 *	900	1.00	300
CLHI608T-R10□-S	100	J, K	15	18	20 *	770	1.20	300
CLHI608T-R12□-S	120 ***	J, K	8 ***	16 ***	23 **	680	1.60	250
CLHI608T-R15□-S	150 ***	J, K	8 ***	14 ***	23 **	550	2.00	250
CLHI608T-R18□-S	180 ***	J, K	8 ***	14 ***	21 **	540	2.40	200

Note : *** at 50MHz ** at 300MHz * at 500MHz

Tolerance : □ - S = $\pm 0.3nH$ J = $\pm 5\%$ K = $\pm 10\%$

Test Conditions : L/Q – Agilent E4991A Fixture – Agilent I6197A

SRF – HP8753D

RDC – HP4338B



ELECTRICAL CHARACTERISTICS CLH2012T (0805) SERIES

PART NO.	INDUCTANCE at 100MHz (nH)	TOLERANCE	Q Min. at 100MHz	Q TYPICAL		SRF (MHz) Min.	DC RESISTANCE (Ω) Max.	RATED CURRENT (mA) Max.
				at 100MHz	at 800MHz			
CLH2012T-1N0□-S	1.0	S	11	13	40	> 6000	0.10	500
CLH2012T-1N2□-S	1.2	S	11	13	40	> 6000	1.10	500
CLH2012T-1N5□-S	1.5	S	11	13	40	> 6000	0.10	500
CLH2012T-1N8□-S	1.8	S	11	13	45	> 6000	0.10	500
CLH2012T-2N2□-S	2.2	S	11	13	48	> 6000	0.10	500
CLH2012T-2N7□-S	2.7	S	11	13	48	> 6000	0.10	500
CLH2012T-3N3□-S	3.3	S, K	13	15	56	> 6000	0.13	500
CLH2012T-3N9□-S	3.9	S, K	13	15	54	5400	0.15	500
CLH2012T-4N7□-S	4.7	S, K	13	15	50	4500	0.20	500
CLH2012T-5N6□-S	5.6	S, K	13	15	53	4000	0.23	500
CLH2012T-6N8□-S	6.8	J, K	13	15	51	3650	0.25	500
CLH2012T-8N2□-S	8.2	J, K	13	15	53	3000	0.28	500
CLH2012T-10N□-S	10	J, K	14	16	45	2500	0.30	500
CLH2012T-12N□-S	12	J, K	14	16	48	2450	0.35	400
CLH2012T-15N□-S	15	J, K	15	17	48	2000	0.40	400
CLH2012T-18N□-S	18	J, K	15	17	43	1750	0.45	400
CLH2012T-22N□-S	22	J, K	15	17	47	1700	0.50	400
CLH2012T-27N□-S	27	J, K	16	18	38	1550	0.55	400
CLH2012T-33N□-S	33	J, K	17	19	35	1350	0.60	400
CLH2012T-39N□-S	39	J, K	19	21	40	1300	0.65	400
CLH2012T-47N□-S	47	J, K	19	21	38	1200	0.70	400
CLH2012T-56N□-S	56	J, K	18	21	31	1150	0.75	400
CLH2012T-68N□-S	68	J, K	19	21	28	1000	0.80	400
CLH2012T-82N□-S	82	J, K	20	22	16	850	0.90	400
CLH2012T-R10□-S	100	J, K	21	23		730	1.00	400
CLH2012T-R12□-S	120 *	J, K	13 *	22		650	1.20	300
CLH2012T-R15□-S	150 *	J, K	13 *	22		550	1.40	300
CLH2012T-R18□-S	180 *	J, K	13 *	23		500	1.80	300
CLH2012T-R22□-S	220 *	J, K	12 *	20		450	2.00	300
CLH2012T-R27□-S	270 *	J, K	12 *	20		400	2.50	300
CLH2012T-R33□-S	330 *	J, K	12 *	22		380	3.00	300

Note: * at 50MHz

Tolerance : □ – S = $\pm 0.3nH$ J = $\pm 5\%$ K = $\pm 10\%$

Test Conditions : L/Q – Agilent E4991A Fixture – Agilent 16197A

SRF – HP8753D

RDC – HP4338B



TAPE DIMENSIONS

Dimensions : mm

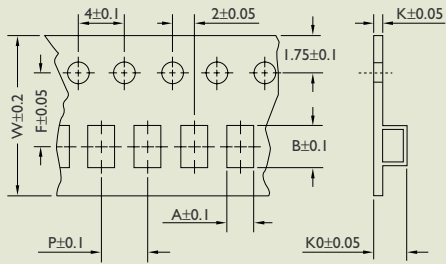

TYPE	A	B	K0	W	P	F	K	
CLH1005	0.65	1.15	0.6	8	2	3.5	0.6	
CLH1608	1.1	1.9	0.95	8	4	3.5	0.95	
CLH2012	< 180nH	1.42	2.25	1.04	8	4	3.5	0.22
	≥ 180nH	1.42	2.25	1.4	8	4	3.5	0.22

TAPE MATERIAL

Carrier Tape : Polystyrene for 201209, 201212

Paper for 160808, 100505

Cover Type : Polyethyene

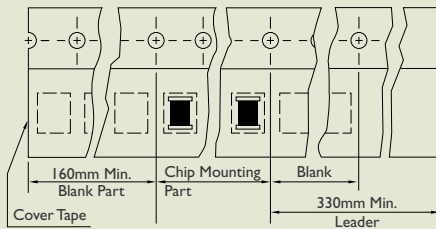

PACKAGING QUANTITY

TYPE	BULK	QUANTITY/REEL
CLH100505	√	10000
CLH160808	√	4000
CLH201209	√	4000
CLH201212	√	3000

REEL DIMENSIONS

Dimensions : mm

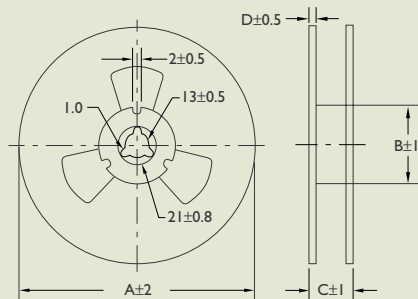

TYPE	A	B	C	D
CLH1005	178	60	12	1.5
CLH1608	178	60	12	1.5
CLH2012	09	178	60	1.5
	12	178	60	1.5

RECOMMENDED PATTERN

Dimensions : mm

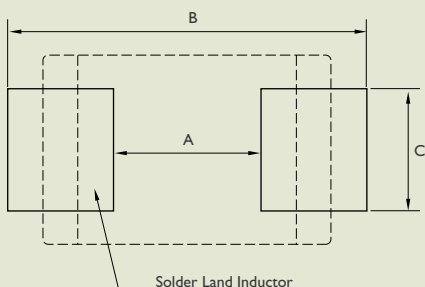

TYPE	A	B	C	
CLH1005	0.4	1.2 ~ 1.4	0.4	
CLH1608	0.8	2.4 ~ 3.4	0.6	
CLH2012	09	1.2	3.0 ~ 4.0	1.0
	12	1.2	3.0 ~ 4.0	1.0



TYPICAL ELECTRICAL CHARACTERISTICS

Test Instruments : HP4291A Impedance / Material Analyzer

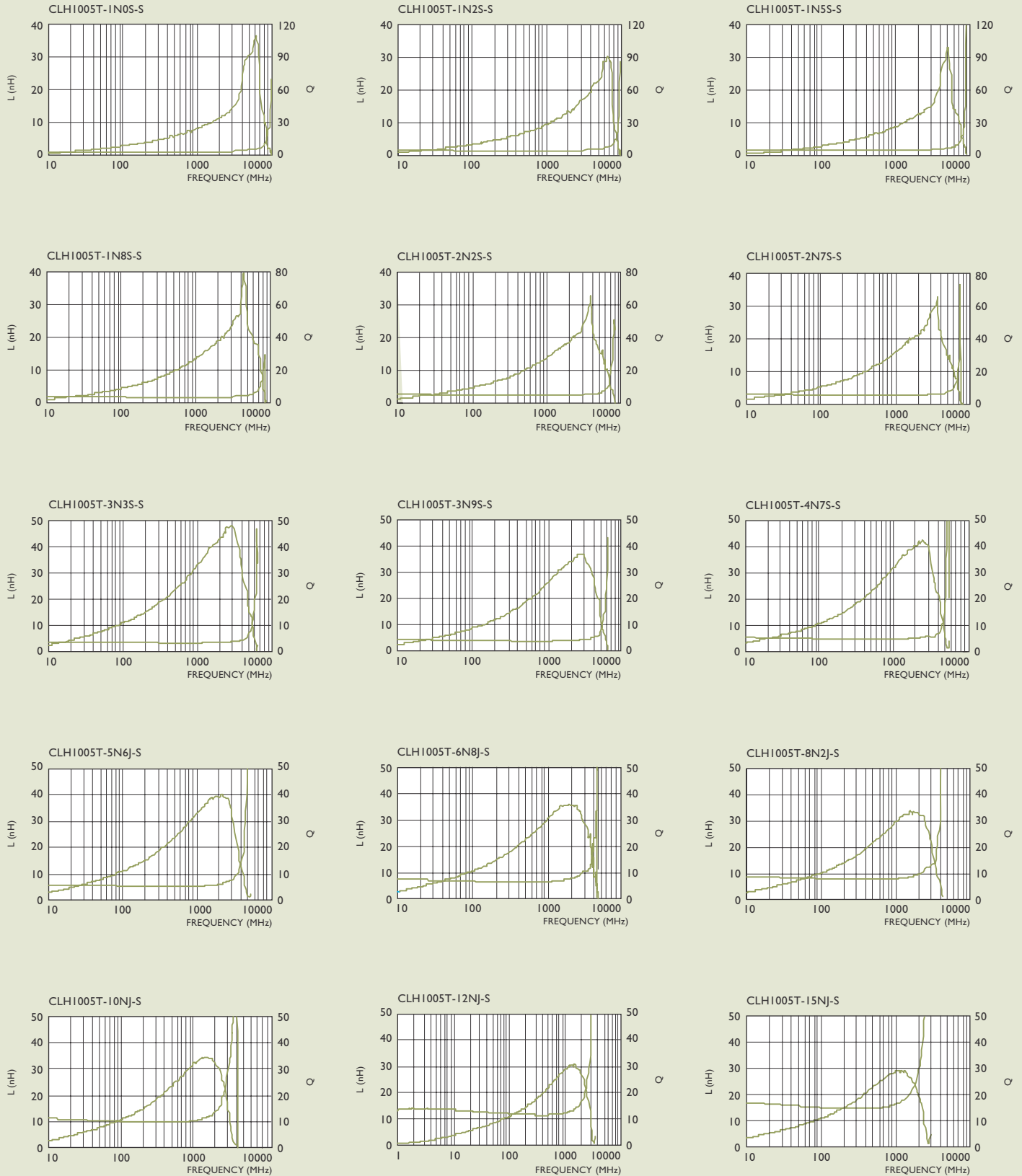



TYPICAL ELECTRICAL CHARACTERISTICS

Test Instruments : HP4291A Impedance / Material Analyzer

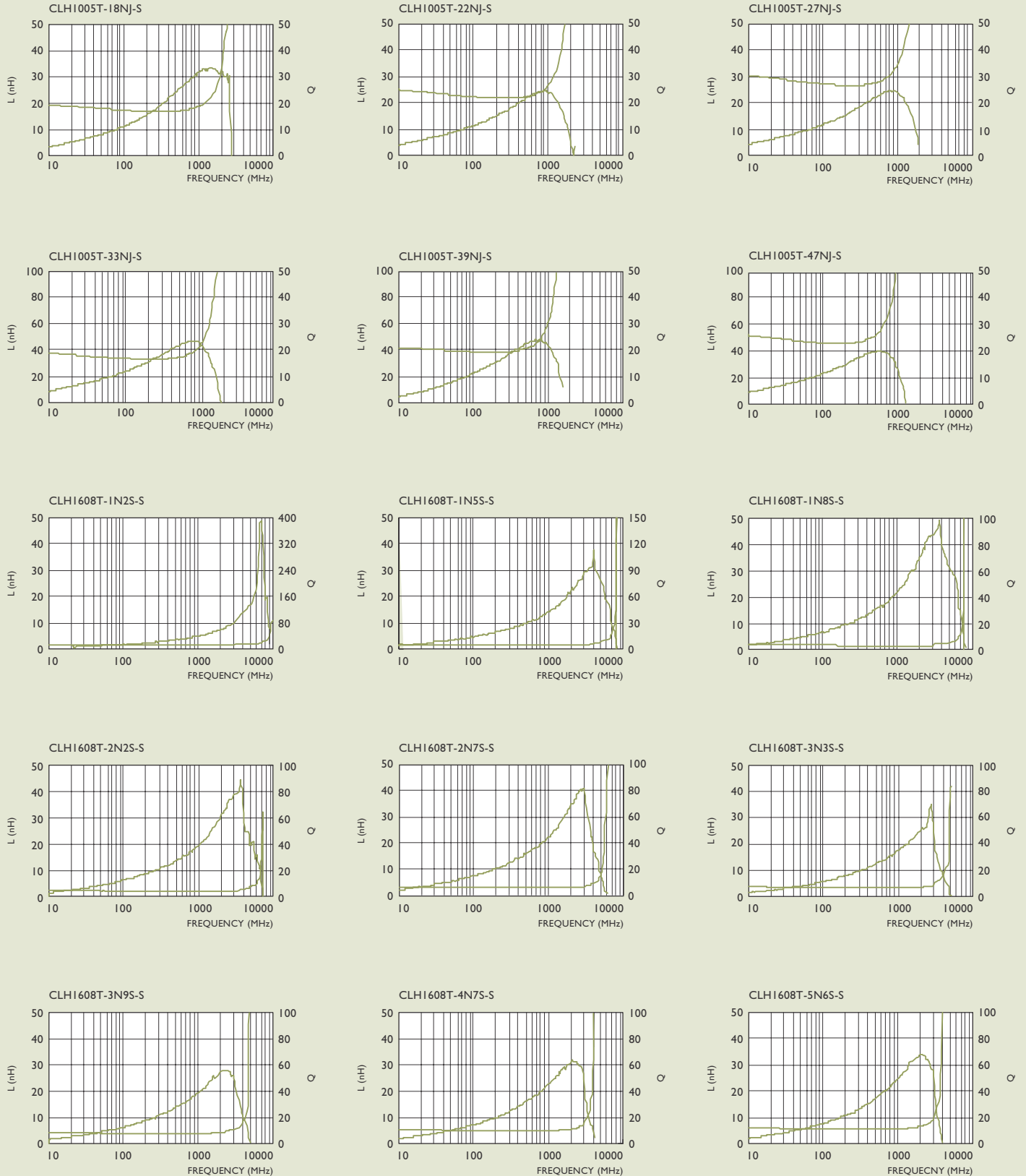



TYPICAL ELECTRICAL CHARACTERISTICS

Test Instruments : HP4291A Impedance / Material Analyzer

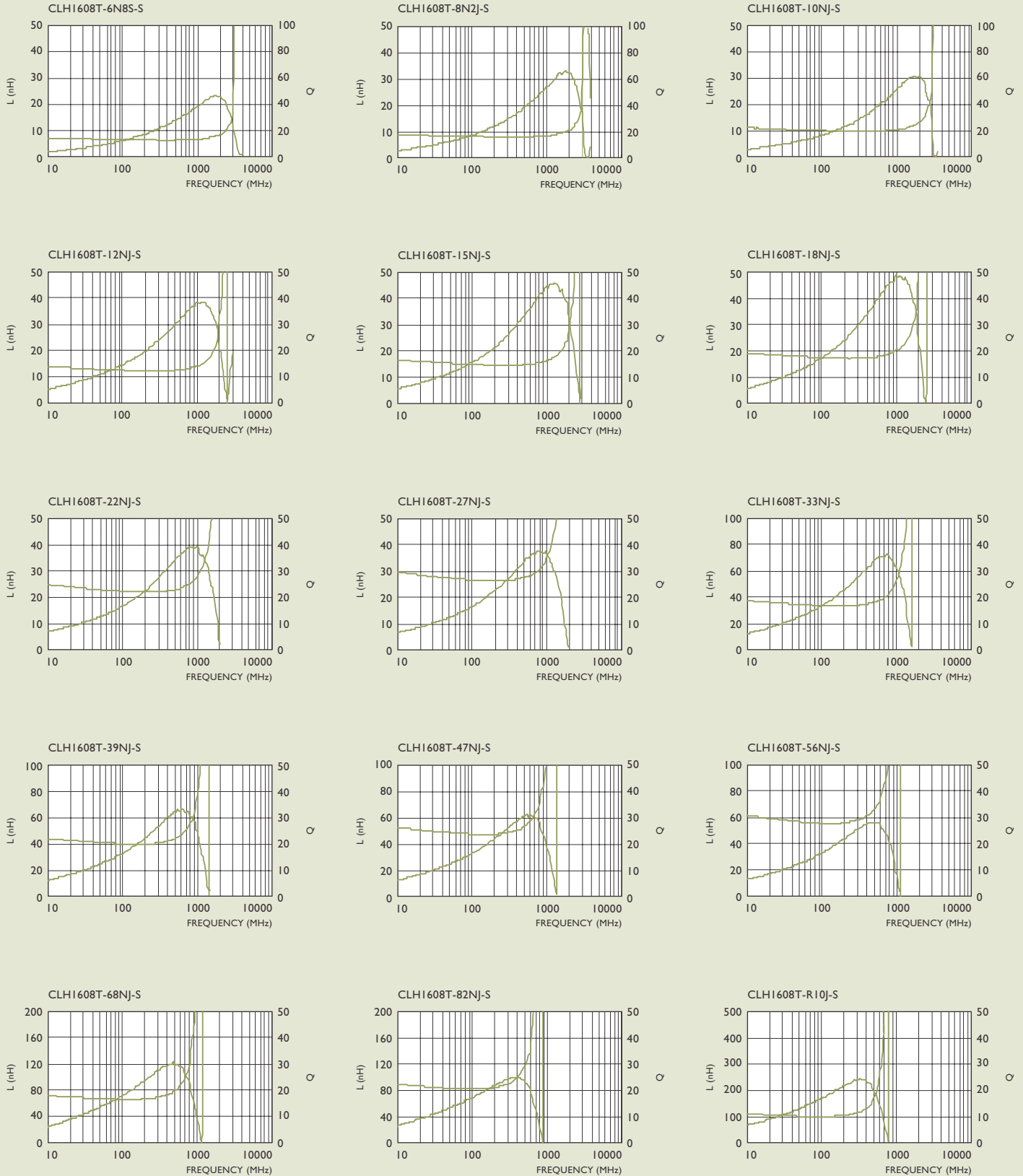



TYPICAL ELECTRICAL CHARACTERISTICS

Test Instruments : HP4291A Impedance / Material Analyzer

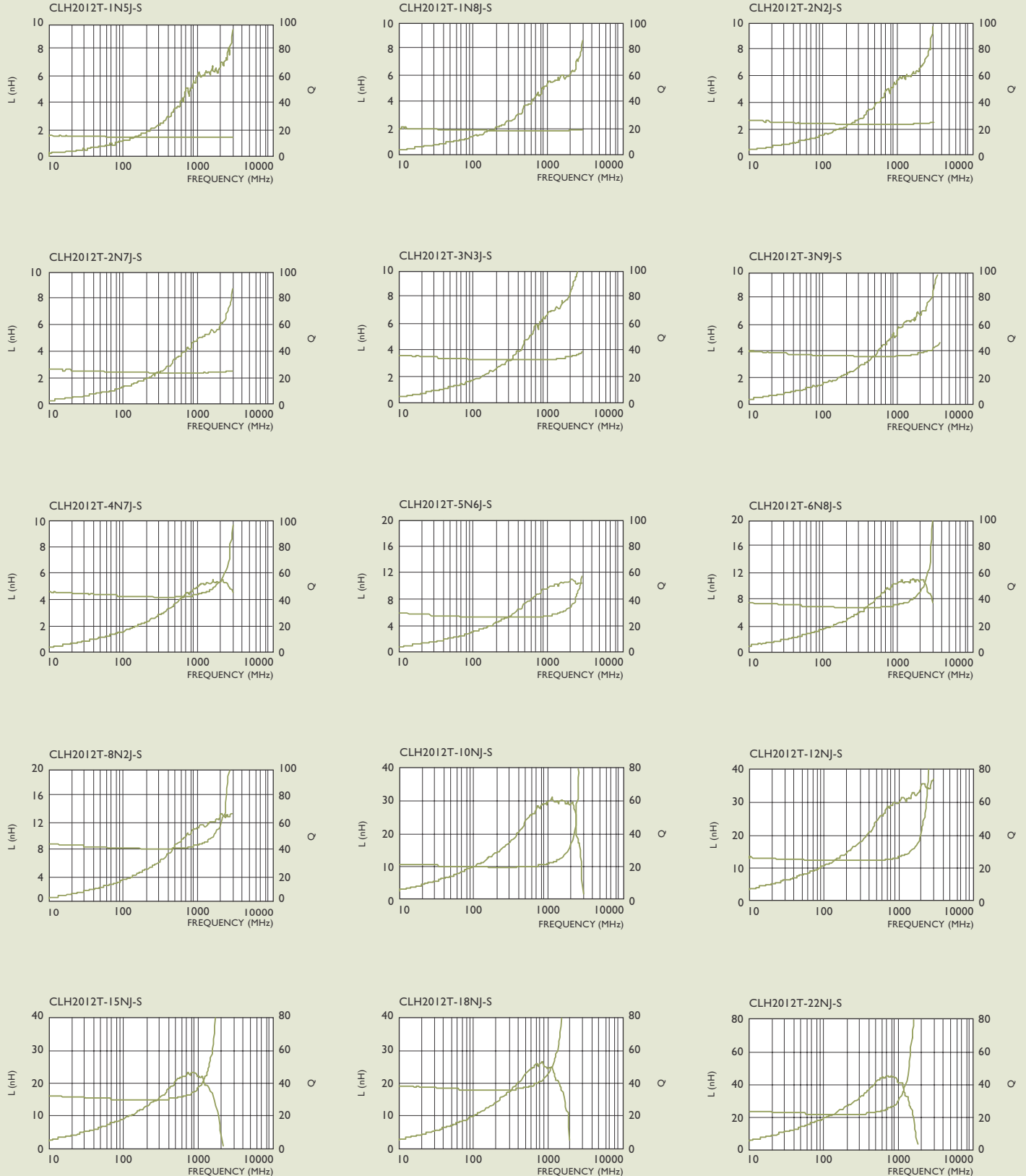



TYPICAL ELECTRICAL CHARACTERISTICS

Test Instruments : HP4291A Impedance / Material Analyzer

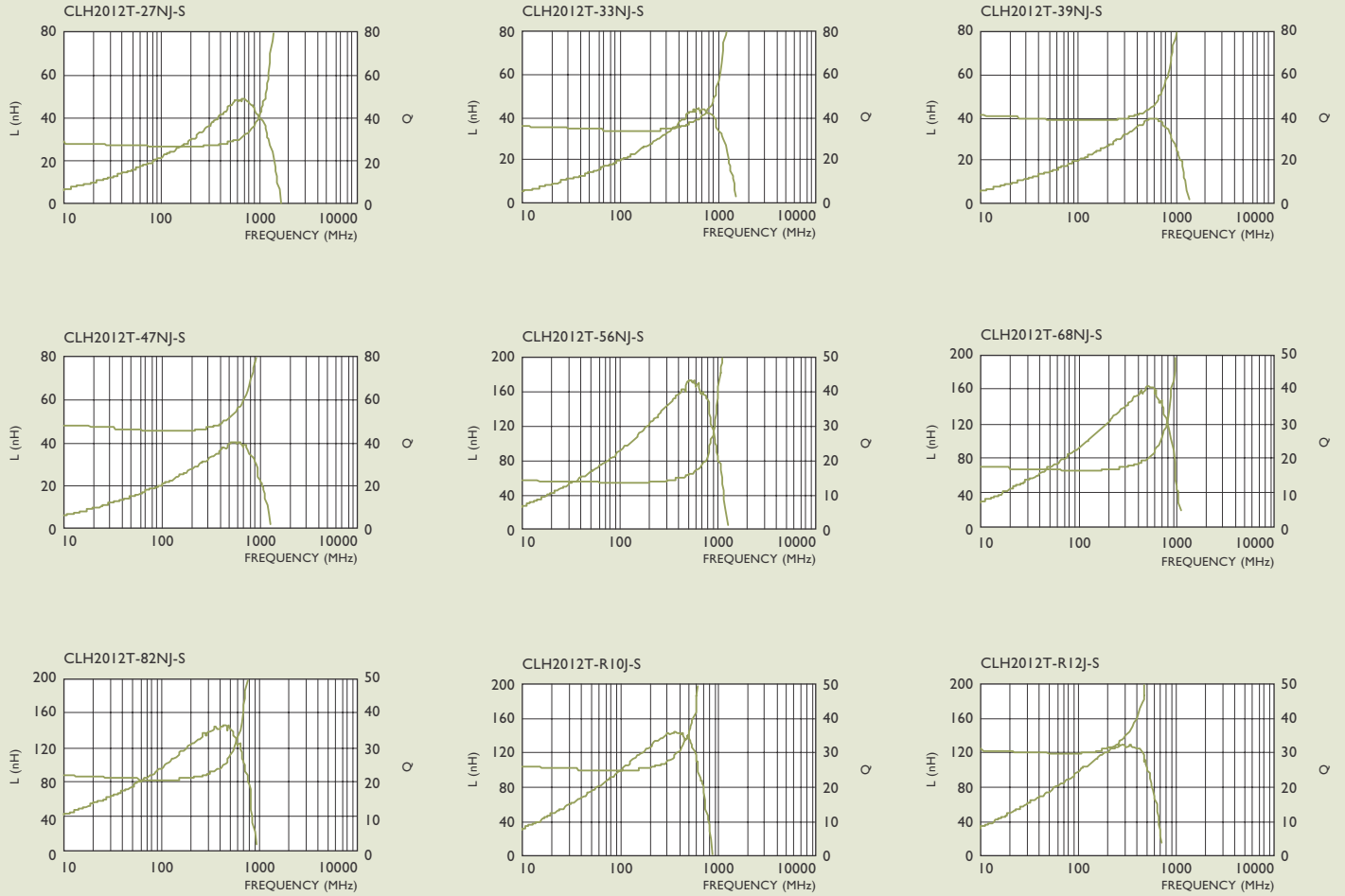



CLH SERIES RELIABILITY TEST

I-1 MECHANICAL PERFORMANCE

NO.	ITEM	SPECIFICATION	TEST CONDITIONS
I-1-1	Flexure Strength	Appearance : No Damage L Change : within $\pm 10\%$ Q Change : within $\pm 30\%$	Test device shall be soldered on the substrate. Substrate Dimension : 100 x 40 x 1.6mm Deflection : 2.0mm Keeping Time : 30Sec. * For 100505, substrate dimension is 100 x 40 x 0.8mm.
I-1-2	Vibration		Test device shall be soldered on the substrate. Oscillation Frequency : 10 to 55 to 10Hz for 1Min. Amplitude : 1.5mm Time : 2Hrs. for each Axis (X,Y & Z), Total 6Hrs.
I-1-3	Resistance to Soldering Heat	Appearance : No Damage	Pre-heating : 150°C, 1Min. Solder Composition : Sn/Pb = 63/37 Solder Temperature : 260 \pm 5°C Immersion Time : 10 \pm 1Sec.
I-1-4	Solderability	The electrodes shall be at least 90% covered with new solder coating.	Pre-heating : 150°C, 1Min. Solder Composition : Sn/Pb = 63/37 Solder Temperature : 230 \pm 5°C Immersion Time : 4 \pm 1Sec.

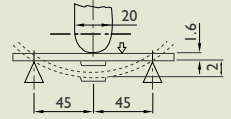

I-2 ENVIRONMENTAL PERFORMANCE

NO.	ITEM	SPECIFICATION	TEST CONDITIONS															
I-2-1	Temperature Cycle	Appearance : No Damage L Change : within $\pm 10\%$ Q Change : within $\pm 30\%$	One Cycle <table border="1"> <thead> <tr> <th>Step</th> <th>Temperature (°C)</th> <th>Time (Min.)</th> </tr> </thead> <tbody> <tr> <td>1</td> <td>-25 \pm 3</td> <td>30</td> </tr> <tr> <td>2</td> <td>25 \pm 2</td> <td>3</td> </tr> <tr> <td>3</td> <td>85 \pm 3</td> <td>30</td> </tr> <tr> <td>4</td> <td>25 \pm 2</td> <td>3</td> </tr> </tbody> </table> Total : 100 Cycles Measured after Exposure in the Room Condition for 24Hrs.	Step	Temperature (°C)	Time (Min.)	1	-25 \pm 3	30	2	25 \pm 2	3	3	85 \pm 3	30	4	25 \pm 2	3
Step	Temperature (°C)	Time (Min.)																
1	-25 \pm 3	30																
2	25 \pm 2	3																
3	85 \pm 3	30																
4	25 \pm 2	3																
I-2-2	Humidity Resistance		Temperature : 40 \pm 2°C Relative Humidity : 90 ~ 95% Time : 1000Hrs. Measured after Exposure in the Room Condition for 24Hrs.															
I-2-3	High Temperature Resistance		Temperature : 85 \pm 3°C Relative Humidity : 20% Applied Current : Rated Current Time : 1000Hrs. Measured after Exposure in the Room Condition for 24Hrs.															
I-2-4	Low Temperature Resistance		Temperature : -25 \pm 3°C Relative Humidity : 0% Time : 1000Hrs. Measured after Exposure in the Room Condition for 24Hrs.															

CS/LCN Series

Wound Chip Inductors High Frequency

CS0603 SERIES

Ceramic body and wire wound construction provide highest SRFs available in 0603 size.

These ultra – compact inductors provided exceptional Q values, even at high frequencies.

CS0805 SERIES

Ceramic body and Wire wound construction provide highest SRFs available in 0805 size.

These ultra – compact inductors provided exceptional Q values, even at high frequencies.

CS1008 SERIES

“ L ” series chip inductors have been designed especially for the needs of today's high frequency designer.

Their ceramic construction delivers the highest possible SRFs as well as excellent Q values.

The non-magnetic coil form also assures the utmost in thermal stability, predictability and batch consistency.

SHAPES AND DIMENSIONS

TYPE	UNIT	A	B	C	D	E	F	G
		Max.	Max.	Max.	Ref.			
CS0603	in	0.071	0.044	0.040	0.015	0.030	0.013	0.034
	mm	1.80	1.12	1.02	0.35	0.86	0.33	0.76
CS0805	in	0.09	0.068	0.06	0.02	0.05	0.02	0.04
	mm	2.29	1.73	1.52	0.50	1.02	0.44	1.27
CS1008	in	0.115	0.11	0.08	0.02	0.08	0.02	0.06
	mm	2.92	2.79	2.03	0.70	1.52	0.51	2.03

CS Series

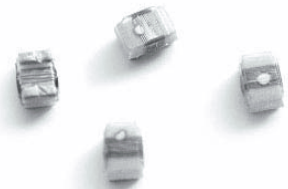

LCN Series



PRODUCT IDENTIFICATION

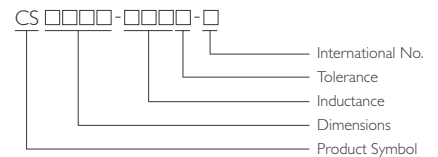

Dimensions : mm

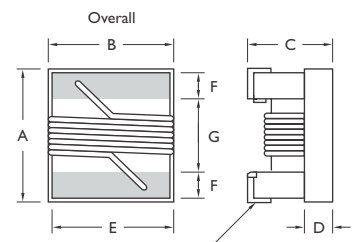

Terminal Wraparound :
 CS0603: Approx. 0.007"/0.18mm Both Ends
 CS0805: Approx. 0.015"/0.38mm Both Ends
 CS1008: Approx. 0.015"/0.38mm Both Ends



ELECTRICAL CHARACTERISTICS CS0603 SERIES

PART NO.	INDUCTANCE (nH)	TOLERANCE (±%)	TEST FREQUENCY (MHz)	Q Min.	SRF (MHz) Min.	DC RESISTANCE (Ω) Max.	RATED CURRENT (mA) Max.	900MHz		1.7 GHz		COLOR CODING
								L TYPE	Q TYPE	L TYPE	Q TYPE	
CS0603-1N6□-S	1.6	10/5	250	24	12500	0.030	700	1.67	49	1.65	63	Red
CS0603-1N8□-S	1.8	10/5	250	16	12500	0.045	700	1.63	35	1.66	50	Black
CS0603-3N6□-S	3.6	10/5	250	22	5900	0.063	700	3.72	53	3.71	65	Red
CS0603-3N9□-S	3.9	10/5	250	22	6900	0.080	700	3.95	49	3.96	67	Brown
CS0603-4N3□-S	4.3	10/5	250	22	5900	0.063	700	4.32	50	4.33	70	Orange
CS0603-4N7□-S	4.7	10/5	250	20	5800	0.116	700	4.72	47	4.75	57	Violet
CS0603-5N1□-S	5.1	10/5	250	20	5700	0.140	700	4.93	47	4.95	56	Green
CS0603-5N6□-S	5.6	10/5	250	20	5800	0.170	700	5.53	56	5.86	77	Yellow
CS0603-6N3□-S	6.3	10/5	250	20	5700	0.140	700	5.5	47	6.1	60	White
CS0603-6N8□-S	6.8	10/5	250	27	5800	0.110	700	6.75	60	7.1	81	Red
CS0603-7N5□-S	7.5	10/5	250	28	4800	0.106	700	7.70	60	7.82	65	Brown
CS0603-8N2□-S	8.2	10/5	250	28	4700	0.109	700	8.30	60	8.50	60	White
CS0603-8N7□-S	8.7	10/5	250	28	4600	0.109	700	8.86	62	9.32	58	Yellow
CS0603-9N5□-S	9.5	10/5	250	28	5400	0.135	700	9.70	59	9.92	61	Blue
CS0603-10N□-S	10	10/5/2	250	31	4800	0.130	700	10	66	10.6	83	Orange
CS0603-11N□-S	11	10/5/2	250	33	4000	0.086	700	11	53	11.5	56	Gray
CS0603-12N□-S	12	10/5/2	250	35	4000	0.130	700	12.3	72	13.5	83	Yellow
CS0603-15N□-S	15	10/5/2	250	35	4000	0.170	700	15.4	64	16.8	89	Green
CS0603-16N□-S	16	10/5/2	250	34	3300	0.104	700	16.2	55	17.3	52	White
CS0603-18N□-S	18	10/5/2	250	35	3100	0.170	700	18.7	70	21.4	69	Blue
CS0603-22N□-S	22	10/5/2	250	38	3000	0.190	700	22.8	73	26.1	71	Violet
CS0603-24N□-S	24	10/5/2	250	37	2650	0.135	700	24.5	45	28.7	39	Black
CS0603-27N□-S	27	10/5/2	250	40	2800	0.220	600	29.2	74	34.6	65	Gray
CS0603-30N□-S	30	10/5/2	250	37	2250	0.144	600	31.4	47	39.9	28	Brown
CS0603-33N□-S	33	10/5/2	250	40	2300	0.220	600	36	67	49.5	42	White
CS0603-36N□-S	36	10/5/2	250	38	2080	0.250	600	39.4	47	52.7	24	Red
CS0603-39N□-S	39	10/5/2	250	40	2200	0.250	600	42.7	60	60.2	40	Black
CS0603-43N□-S	43	10/5/2	250	39	2000	0.280	600	47	44	64.9	21	Orange
CS0603-47N□-S	47	10/5/2	200	38	2000	0.280	600	52.2	62	77.2	35	Brown
CS0603-56N□-S	56	10/5/2	200	38	1900	0.310	600	62.5	56	97	26	Red
CS0603-68N□-S	68	10/5/2	200	37	1700	0.340	600	80.5	54	168	21	Orange
CS0603-72N□-S	72	10/5/2	150	34	1700	0.490	400	82	53	135	20	Yellow
CS0603-82N□-S	82	10/5/2	150	34	1700	0.540	400	96.2	54	177	21	Green
CS0603-R10□-S	100	10/5/2	150	34	1400	0.580	400	124	49	-	-	Blue
CS0603-R11□-S	110	10/5/2	150	32	1350	0.610	300	138	43	-	-	Violet
CS0603-R12□-S	120	10/5/2	150	32	1300	0.650	300	166	39	-	-	Gray
CS0603-R15□-S	150	10/5/2	150	28	990	0.920	280	250	25	-	-	White
CS0603-R18□-S	180	10/5/2	100	25	990	1.250	240	305	22	-	-	Black
CS0603-R22□-S	220	10/5/2	100	25	900	2.100	200	-	-	-	-	Brown
CS0603-R27□-S	270	10/5/2	100	24	900	2.300	170	-	-	-	-	Red
CS0603-R33□-S	330	10/5/2	100	25	900	3.890	100	-	-	-	-	Orange
CS0603-R39□-S	390	10/5/2	100	25	900	4.350	100	-	-	-	-	Yellow

- When ordering, please specify tolerance and packaging code. Ex : CS0603-R12□-S
Tolerance : G = 2% , J = 5% , K = 10% , M = 20%
Packaging : ClearTape and Reel (Standard)

- L, Q : HP4287A
- SRF : E4991A / HP8753D
- RDC : Digital Multimeter SC-7401
- For 15°C Rise
- Operating Temperature Range -40°C to 125°C



ELECTRICAL CHARACTERISTICS CS0805 SERIES

PART NO.	INDUCTANCE (nH)	TOLERANCE (±%)	TEST FREQUENCY (MHz)	Q Min.	TEST FREQUENCY (MHz)	SRF (MHz) Min.	DC RESISTANCE (Ω) Max.	RATED CURRENT (mA) Max.	COLOR CODING
CS0805-2N8□-S	2.8	10/5	250	80	1500	7900	0.06	800	Gray
CS0805-3N0□-S	3.0	10/5	250	65	1500	7900	0.06	800	White
CS0805-3N3□-S	3.3	10/5	250	50	1500	7900	0.08	600	Black
CS0805-5N6□-S	5.6	10/5	250	65	1000	5500	0.08	600	Orange
CS0805-6N8□-S	6.8	10/5	250	50	1000	5500	0.11	600	Brown
CS0805-7N5□-S	7.5	10/5	250	50	1000	4500	0.14	600	Green
CS0805-8N2□-S	8.2	10/5	250	50	1000	4700	0.12	600	Red
CS0805-12N□-S	12	10/5/2	250	50	500	4000	0.15	600	Orange
CS0805-15N□-S	15	10/5/2	250	50	500	3400	0.17	600	Yellow
CS0805-18N□-S	18	10/5/2	250	50	500	3300	0.20	600	Green
CS0805-22N□-S	22	10/5/2	250	55	500	2600	0.22	500	Blue
CS0805-24N□-S	24	10/5/2	250	50	500	2000	0.22	500	Gray
CS0805-27N□-S	27	10/5/2	250	55	500	2500	0.25	500	Violet
CS0805-33N□-S	33	10/5/2	250	60	500	2050	0.27	500	Gray
CS0805-36N□-S	36	10/5/2	250	55	500	1700	0.27	500	Orange
CS0805-39N□-S	39	10/5/2	250	60	500	2000	0.29	500	White
CS0805-43N□-S	43	10/5/2	200	60	500	1650	0.34	500	Yellow
CS0805-47N□-S	47	10/5/2	200	60	500	1650	0.31	500	Black
CS0805-56N□-S	56	10/5/2	200	60	500	1550	0.34	500	Brown
CS0805-68N□-S	68	10/5/2	200	60	500	1450	0.38	500	Red
CS0805-82N□-S	82	10/5/2	150	65	500	1300	0.42	400	Orange
CS0805-91N□-S	91	10/5/2	150	65	500	1200	0.48	400	Black
CS0805-R10□-S	100	10/5/2	150	65	500	1200	0.46	400	Yellow
CS0805-R11□-S	110	10/5/2	150	50	250	1000	0.48	400	Brown
CS0805-R12□-S	120	10/5/2	150	50	250	1100	0.51	400	Green
CS0805-R15□-S	150	10/5/2	100	50	250	920	0.56	400	Blue
CS0805-R18□-S	180	10/5/2	100	50	250	870	0.64	400	Violet
CS0805-R20□-S	200	10/5/2	100	50	250	860	0.68	400	Red
CS0805-R22□-S	220	10/5/2	100	50	250	850	0.70	400	Gray
CS0805-R24□-S	240	10/5/2	100	44	250	690	1.00	350	Red
CS0805-R25□-S	250	10/5/2	100	45	250	660	1.20	350	Yellow
CS0805-R27□-S	270	10/5/2	100	48	250	650	1.00	350	White
CS0805-R33□-S	330	10/5/2	100	48	250	600	1.40	310	Black
CS0805-R39□-S	390	10/5/2	100	48	250	560	1.50	290	Brown
CS0805-R47□-S	470	10/5/2	50	33	100	375	1.76	250	Violet
CS0805-R56□-S	560	10/5/2	25	23	50	340	1.90	230	Orange
CS0805-R62□-S	620	10/5/2	25	23	50	220	2.20	210	White
CS0805-R68□-S	680	10/5/2	25	23	50	188	2.20	190	Green
CS0805-R82□-S	820	10/5/2	25	23	50	215	2.35	180	Blue
CS0805-1R0□-S	1000	10/5/2	25	20	60	100	2.50	170	Violet

• When ordering, please specify tolerance and packaging code. Ex : CS0805-R10□-S

Tolerance : G = 2% , J = 5% , K = 10% , M = 20%

Packaging : Clear Tape and Reel (Standard)

• L, Q, RDC : HP4287A

• SRF : E4991A / HP8753D

• Operating Temperature Range -40°C to 125°C

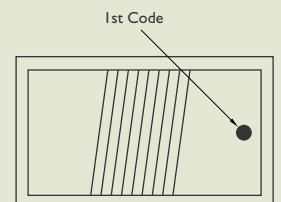

Color Coding



ELECTRICAL CHARACTERISTICS CSI008 SERIES

PART NO.	INDUCTANCE (nH)	TOLERANCE (±%)	TEST FREQUENCY (MHz)	Q Min.	TEST FREQUENCY (MHz)	SRF (MHz) Min.	DC RESISTANCE (Ω) Max.	RATED CURRENT (mA) Max.	COLOR CODING		
									1 st	2 nd	3 rd
CSI008-10N□-S	10	10/5/2	50	50	500	4100	0.08	1000	Brown	Black	Black
CSI008-12N□-S	12	10/5/2	50	50	500	3300	0.09	1000	Brown	Red	Black
CSI008-15N□-S	15	10/5/2	50	50	500	2500	0.10	1000	Brown	Green	Black
CSI008-18N□-S	18	10/5/2	50	50	350	2500	0.11	1000	Brown	Gray	Black
CSI008-22N□-S	22	10/5/2	50	55	350	2400	0.12	1000	Red	Red	Black
CSI008-27N□-S	27	10/5/2	50	55	350	1600	0.13	1000	Red	Violet	Black
CSI008-33N□-S	33	10/5/2	50	60	350	1600	0.14	1000	Orange	Orange	Black
CSI008-39N□-S	39	10/5/2	50	60	350	1500	0.15	1000	Orange	White	Black
CSI008-47N□-S	47	10/5/2	50	65	350	1500	0.16	1000	Yellow	Violet	Black
CSI008-56N□-S	56	10/5/2	50	65	350	1300	0.18	1000	Green	Blue	Black
CSI008-68N□-S	68	10/5/2	50	65	350	1300	0.20	1000	Blue	Gray	Black
CSI008-82N□-S	82	10/5/2	50	60	350	1000	0.22	1000	Gray	Red	Black
CSI008-R10□-S	100	10/5/2	25	60	350	1000	0.56	650	Brown	Black	Brown
CSI008-R12□-S	120	10/5/2	25	60	350	950	0.63	650	Brown	Red	Brown
CSI008-R15□-S	150	10/5/2	25	45	100	850	0.70	580	Brown	Green	Brown
CSI008-R18□-S	180	10/5/2	25	45	100	750	0.77	620	Brown	Gray	Brown
CSI008-R22□-S	220	10/5/2	25	45	100	700	0.84	500	Red	Red	Brown
CSI008-R27□-S	270	10/5/2	25	45	100	600	0.91	500	Red	Violet	Brown
CSI008-R33□-S	330	10/5/2	25	45	100	570	1.05	450	Orange	Orange	Brown
CSI008-R39□-S	390	10/5/2	25	45	100	500	1.12	470	Orange	White	Brown
CSI008-R47□-S	470	10/5/2	25	45	100	450	1.19	470	Yellow	Violet	Brown
CSI008-R56□-S	560	10/5/2	25	45	100	415	1.33	400	Green	Blue	Brown
CSI008-R62□-S	620	10/5/2	25	45	100	375	1.40	300	Blue	Red	Brown
CSI008-R68□-S	680	10/5/2	25	45	100	375	1.47	400	Blue	Gray	Brown
CSI008-R75□-S	750	10/5/2	25	45	100	360	1.54	360	Violet	Green	Brown
CSI008-R82□-S	820	10/5/2	25	45	100	350	1.61	400	Gray	Red	Brown
CSI008-R91□-S	910	10/5/2	25	35	50	320	1.68	380	White	Brown	Brown
CSI008-1R0□-S	1000	10/5/2	25	35	50	290	1.75	370	Brown	Black	Red
CSI008-1R2□-S	1200	10/5/2	7.9	35	50	250	2.0	310	Brown	Red	Red
CSI008-1R5□-S	1500	10/5/2	7.9	28	50	200	2.3	330	Brown	Green	Red
CSI008-1R8□-S	1800	10/5/2	7.9	28	50	160	2.6	300	Brown	Gray	Red
CSI008-2R2□-S	2200	10/5/2	7.9	28	50	160	2.8	280	Red	Red	Red
CSI008-2R7□-S	2700	10/5/2	7.9	22	25	140	3.2	290	Red	Violet	Red
CSI008-3R3□-S	3300	10/5/2	7.9	22	25	110	3.4	290	Orange	Orange	Red
CSI008-3R9□-S	3900	10/5/2	7.9	20	25	100	3.6	260	Orange	White	Red
CSI008-4R7□-S	4700	10/5/2	7.9	20	25	90	4.0	260	Yellow	Violet	Red
CSI008-5R6□-S	5600	10/5/2	7.9	16	7.9	20	4.0	240	Green	Blue	Red
CSI008-6R8□-S	6800	10/5/2	7.9	18	7.9	40	4.9	200	Blue	Gray	Red
CSI008-8R2□-S	8200	10/5/2	7.9	18	7.9	25	6.0	170	Gray	Red	Red
CSI008-100□-S	10000	10/5/2	7.9	18	7.9	25	8.0	150	Brown	Black	Orange

• When ordering, please specify tolerance and packaging code. Ex : CSI008-3R3□-S

Tolerance : G = 2% , J = 5% , K = 10%

Packaging : Clear Tape and Reel (Standard)

• L, Q, RDC : HP4287A

• SRF : E4991A / HP8753D

• RDC : Digital Multimeter SC-7401

• Operating Temperature Range -40°C to 125°C

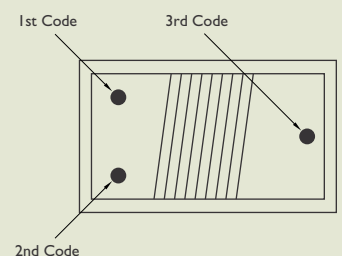

Color Coding



TAPE DIMENSIONS

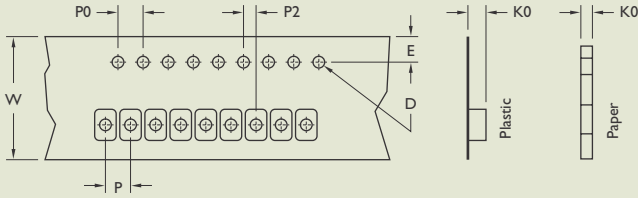

TAPE MATERIAL

Carrier Tape : Polystyrene

Cover Type : Polyethylene

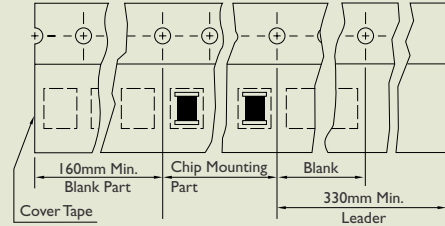

REEL DIMENSIONS

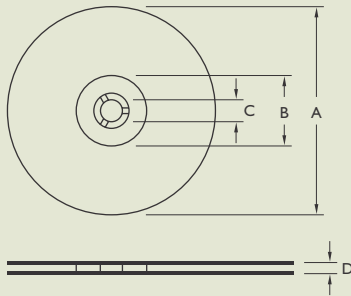

RECOMMENDED PATTERN

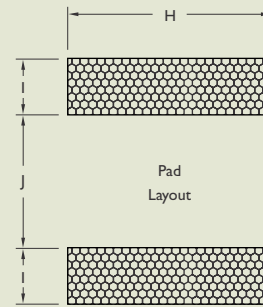

Dimensions : mm

TYPE	TAPE DIMENSIONS							REEL DIMENSIONS				RECOMMENDED PATTERN			QUANTITY /REEL	
	K0	D	E	W	P	P0	P2	A	B	C	D	UNIT	H	I		J
CS0603	1.15	1.83	0.23	8	4	4	2	178	60	12	1.5	in	0.040	0.025	0.025	4000
												mm	1.02	0.64	0.64	
CS0805	1.85	2.45	0.23	8	4	4	2	178	60	12	1.5	in	0.07	0.04	0.03	2000
												mm	1.78	1.02	0.76	
CS1008	2.70	2.95	0.23	8	4	4	2	178	60	12	1.5	in	0.10	0.04	0.05	2000
												mm	2.54	1.02	1.27	



TYPICAL ELECTRICAL CHARACTERISTICS

Test Instruments : E4991A Impedance / Material Analyzer

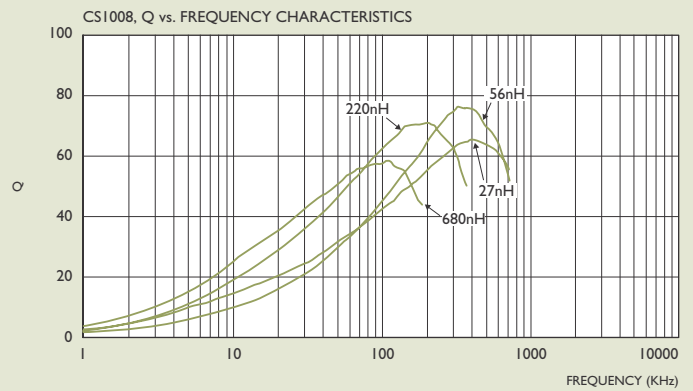
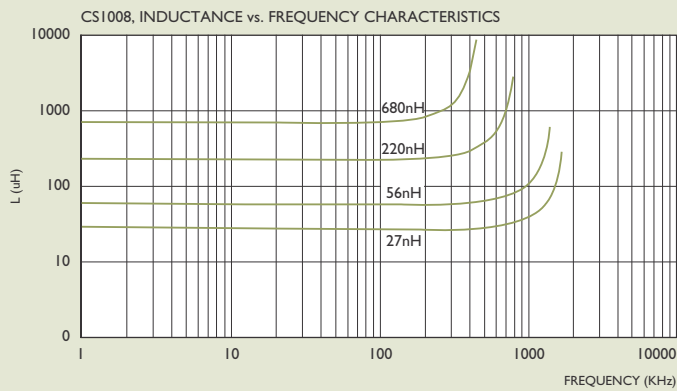
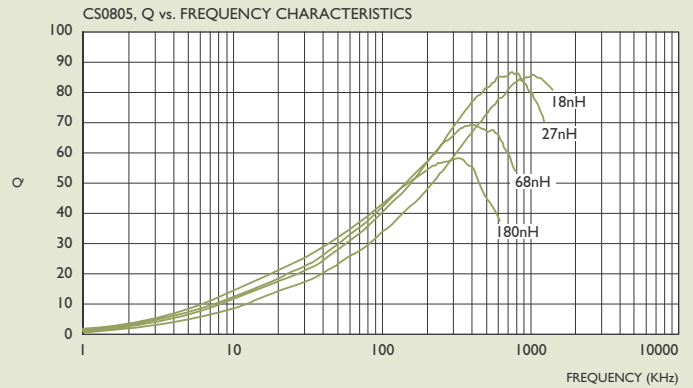
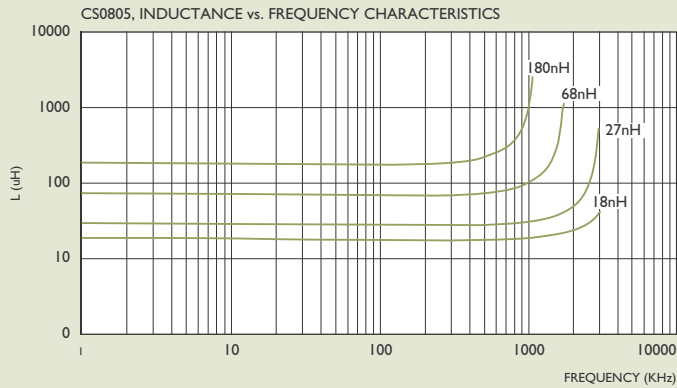
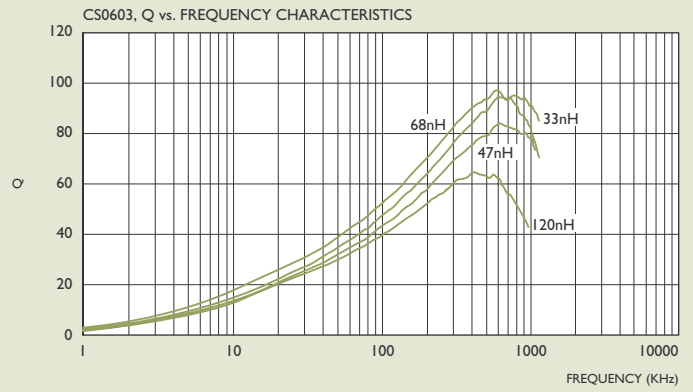
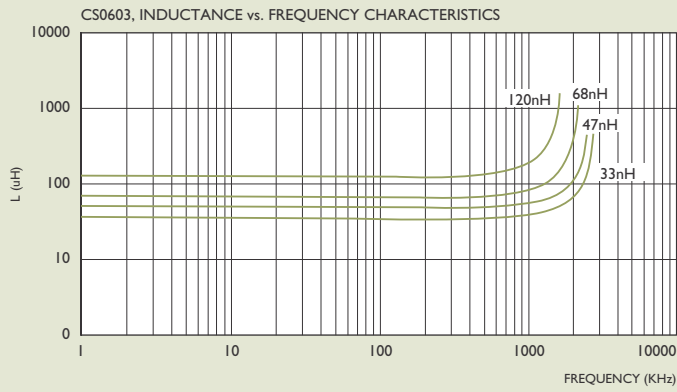



WOUND CHIP INDUCTORS LCN0603 SERIES

Ceramic body and wire wound construction provide highest SRFs available in 0603 size.

These ultra-compact inductors provided exceptional Q values, even at high frequencies.

Product Identification

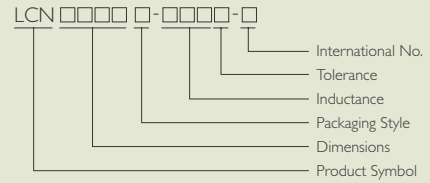
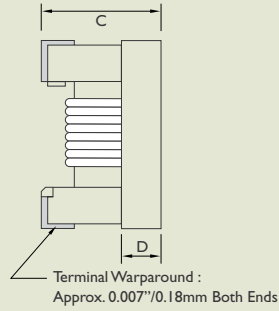
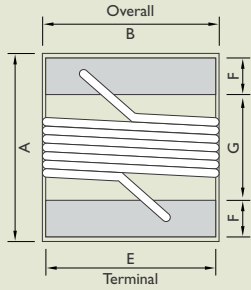

Dimensions : mm

UNIT	A Max.	B Max.	C Max.	D Ref.	E	F	G
in	0.071	0.044	0.040	0.015	0.030	0.013	0.034
mm	2.35	1.73	1.02	0.35	1.02	0.44	1.27

Test Instruments : E4991A Impedance / Material Analyzer

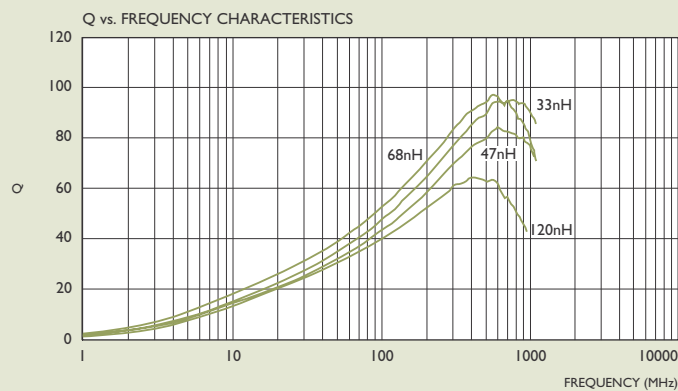
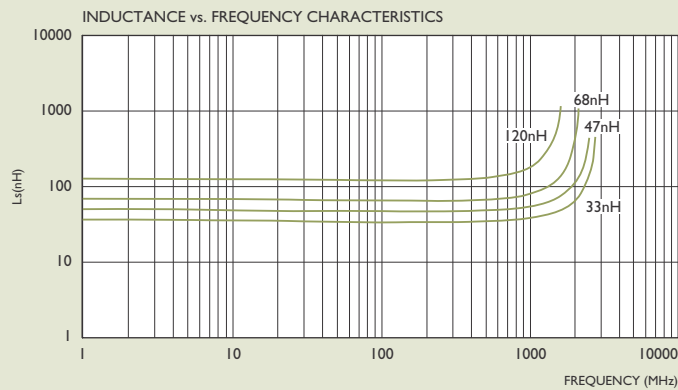



ELECTRICAL CHARACTERISTICS LCN0603 SERIES

PART NO.	INDUCTANCE at 250MHz (nH)	TOLERANCE (%)	Q Min.	SRF (MHz) Min.	DC RESISTANCE (Ω) Max.	RATED CURRENT (mA) Max.	900MHz		1.7 GHz		COLOR
							L TYPE	Q TYPE	L TYPE	Q TYPE	
LCN0603T-1N6□-S	1.6	10	24	12500	0.030	700	1.67	49	1.65	63	Red
LCN0603T-1N8□-S	1.8	10	16	12500	0.045	700	1.63	35	1.66	50	Black
LCN0603T-3N6□-S	3.6	10	22	5900	0.063	700	3.72	53	3.71	65	Red
LCN0603T-3N9□-S	3.9	10	22	6900	0.080	700	3.95	49	3.96	67	Brown
LCN0603T-4N3□-S	4.3	10	22	5900	0.063	700	4.32	50	4.33	70	Orange
LCN0603T-4N7□-S	4.7	10	20	5800	0.116	700	4.72	47	4.75	57	Violet
LCN0603T-5N1□-S	5.1	10	20	5700	0.140	700	4.93	47	4.95	56	Green
LCN0603T-6N3□-S	6.3	10	20	5700	0.140	700	5.5	47	6.1	60	White
LCN0603T-6N8□-S	6.8	10	27	5800	0.110	700	6.75	60	7.1	81	Red
LCN0603T-7N5□-S	7.5	10	28	4800	0.106	700	7.70	60	7.82	65	Brown
LCN0603T-8N2□-S	8.2	10	28	4700	0.109	700	8.30	60	8.50	60	White
LCN0603T-8N7□-S	8.7	5	28	4600	0.109	700	8.86	62	9.32	58	Yellow
LCN0603T-9N5□-S	9.5	5	28	5400	0.135	700	9.70	59	9.92	61	Blue
LCN0603T-10N□-S	10	5	31	4800	0.130	700	10	66	10.6	83	Orange
LCN0603T-11N□-S	11	5	33	4000	0.086	700	11	53	11.5	56	Gray
LCN0603T-12N□-S	12	5	35	4000	0.130	700	12.3	72	13.5	83	Yellow
LCN0603T-15N□-S	15	5	35	4000	0.170	700	15.4	64	16.8	89	Green
LCN0603T-16N□-S	16	5	34	3300	0.104	700	16.2	55	17.3	52	White
LCN0603T-18N□-S	18	5	35	3100	0.170	700	18.7	70	21.4	69	Blue
LCN0603T-22N□-S	22	5	38	3000	0.190	700	22.8	73	26.1	71	Violet
LCN0603T-24N□-S	24	5	37	2650	0.135	700	24.5	45	28.7	39	Black
LCN0603T-27N□-S	27	5	40	2800	0.220	600	29.2	74	34.6	65	Gray
LCN0603T-30N□-S	30	5	37	2250	0.144	600	31.4	47	39.9	28	Brown
LCN0603T-33N□-S	33	5	40	2300	0.220	600	36	67	49.5	42	White
LCN0603T-36N□-S	36	5	38	2080	0.250	600	39.4	47	52.7	24	Red
LCN0603T-39N□-S	39	5	40	2200	0.250	600	42.7	60	60.2	40	Black
LCN0603T-43N□-S	43	5	39	2000	0.280	600	47	44	64.9	21	Orange
LCN0603T-47N□-S	47 *	5	38	2000	0.280	600	52.2	62	77.2	35	Brown
LCN0603T-56N□-S	56 *	5	38	1900	0.310	600	62.5	56	97	26	Red
LCN0603T-68N□-S	68 *	5	37	1700	0.340	600	80.5	54	168	21	Orange
LCN0603T-72N□-S	72 **	5	34	1700	0.490	400	82	53	135	20	Yellow
LCN0603T-82N□-S	82 **	5	34	1700	0.540	400	96.2	54	177	21	Green
LCN0603T-R10□-S	100 ***	5	34	1400	0.580	400	124	49			Blue
LCN0603T-R11□-S	110 ***	5	32	1350	0.610	300	138	43			Violet
LCN0603T-R12□-S	120 **	5	32	1300	0.650	300	166	39			Gray
LCN0603T-R15□-S	150 **	5	28	990	0.920	280	250	25			White
LCN0603T-R18□-S	180 ***	5	25	990	1.250	240	305	22			Black
LCN0603T-R22□-S	220 ***	5	25	900	2.100	200	480	8			Brown
LCN0603T-R27□-S	270 ***	5	24	900	2.300	170	980	4			Red

Note : * at 200MHz ** at 150MHz *** at 100MHz

When ordering, please specify tolerance and packaging code.

Ex : LCN0603T-R12J-S Tolerance : G = $\pm 2\%$, J = 5%, K = 10%, M = 20%

Packaging : Clear Tape and Reel (Standard)

L, Q : HP4287A SRF : HP8753D / E4991A

RDC : Digital Multimeter SC-7401/4291A For 15°C Rise

Operating Temperature Range -40°C to 125°C



WOUND CHIP INDUCTORS LCN0805 SERIES

Ceramic body and wire wound construction provide highest SRFs available in 0805 size.

These ultra-compact inductors provided exceptional Q values, even at high frequencies.

Color Coding

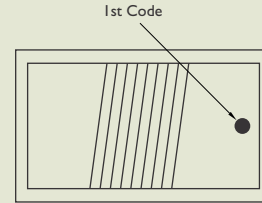
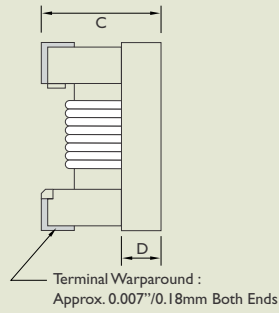
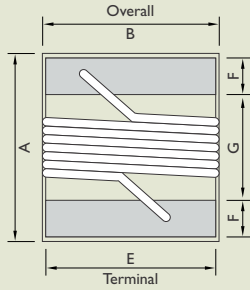

Dimensions : mm

UNIT	A Max.	B Max.	C Max.	D Ref.	E	F	G
in	0.09	0.068	0.06	0.02	0.05	0.02	0.04
mm	2.29	1.73	1.52	0.51	1.27	0.51	1.02

Test Instruments : E4991A Impedance / Material Analyzer

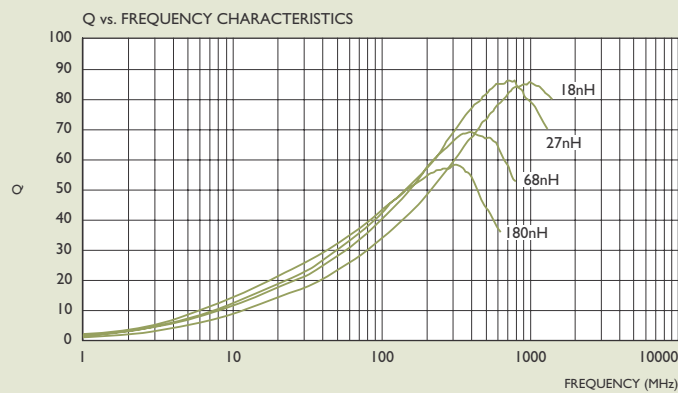
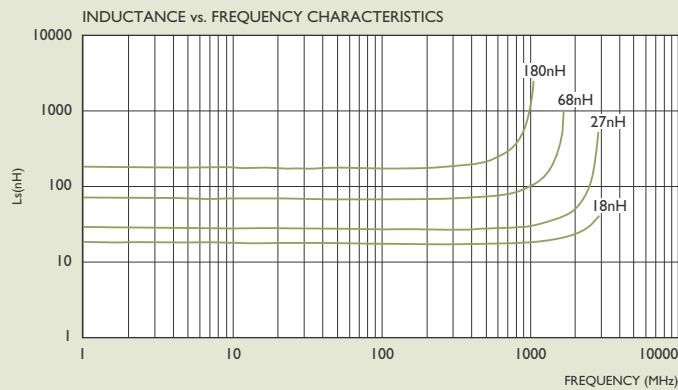



ELECTRICAL CHARACTERISTICS LCN0805 SERIES

PART NO.	INDUCTANCE at 250MHz (nH)	TOLERANCE (±%)	Q Min.	TEST FREQUENCY (MHz)	SRF (MHz) Min.	DC RESISTANCE (Ω) Max.	RATED CURRENT (mA) Max.	COLOR CODING
LCN0805T-2N8□-S	2.8	10	70	1500	7900	0.06	800	Gray
LCN0805T-3N0□-S	3.0	10	65	1500	7900	0.06	800	White
LCN0805T-3N3□-S	3.3	10	50	1500	7900	0.08	600	Black
LCN0805T-5N6□-S	5.6	10	65	1000	5500	0.08	600	Orange
LCN0805T-6N8□-S	6.8	10	50	1000	5500	0.11	600	Brown
LCN0805T-7N5□-S	7.5	10	50	1000	4500	0.14	600	Green
LCN0805T-8N2□-S	8.2	10	50	1000	4700	0.12	600	Red
LCN0805T-10N□-S	10	10	60	500	4200	0.10	600	Blue
LCN0805T-12N□-S	12	10	50	500	4000	0.15	600	Orange
LCN0805T-15N□-S	15	5	50	500	3400	0.17	600	Yellow
LCN0805T-18N□-S	18	5	50	500	3300	0.20	600	Green
LCN0805T-22N□-S	22	5	55	500	2600	0.22	500	Blue
LCN0805T-24N□-S	24	5	50	500	2000	0.22	500	Gray
LCN0805T-27N□-S	27	5	55	500	2500	0.25	500	Violet
LCN0805T-33N□-S	33	5	60	500	2050	0.27	500	Gray
LCN0805T-36N□-S	36	5	55	500	1700	0.27	500	Orange
LCN0805T-39N□-S	39	5	60	500	2000	0.29	500	White
LCN0805T-43N□-S	43 *	5	60	500	1650	0.34	500	Yellow
LCN0805T-47N□-S	47 *	5	60	500	1650	0.31	500	Black
LCN0805T-56N□-S	56 *	5	60	500	1550	0.34	500	Brown
LCN0805T-68N□-S	68 *	5	60	500	1450	0.38	500	Red
LCN0805T-82N□-S	82 **	5	65	500	1300	0.42	400	Orange
LCN0805T-91N□-S	91 **	5	65	500	1200	0.48	400	Black
LCN0805T-R10□-S	100 **	5	65	500	1200	0.46	400	Yellow
LCN0805T-R11□-S	110 **	5	50	250	1000	0.48	400	Brown
LCN0805T-R12□-S	120 **	5	50	250	1100	0.51	400	Green
LCN0805T-R15□-S	150 ***	5	50	250	920	0.56	400	Blue
LCN0805T-R18□-S	180 ***	5	50	250	870	0.64	400	Violet
LCN0805T-R20□-S	200 ***	5	50	250	860	0.68	400	Red
LCN0805T-R22□-S	220 ***	5	50	250	850	0.70	400	Gray
LCN0805T-R24□-S	240 ***	5	44	250	690	1.00	350	Red
LCN0805T-R25□-S	250 ***	5	45	250	660	1.20	350	Yellow
LCN0805T-R27□-S	270 ***	5	48	250	650	1.30	350	White
LCN0805T-R33□-S	330 ***	5	48	250	600	1.65	310	Black
LCN0805T-R39□-S	390 ***	5	25	250	400	1.80	290	Brown
LCN0805T-R47□-S	470 ****	5	33	100	400	2.00	250	Violet
LCN0805T-R56□-S	560 *****	5	20	50	200	2.10	230	Orange
LCN0805T-R68□-S	680 *****	5	18	50	130	2.30	190	Green
LCN0805T-R82□-S	820 *****	5	15	50	100	2.50	180	Blue

Note : * at 200MHz ** at 150MHz *** at 100MHz **** at 50MHz ***** at 25MHz

When ordering, please specify tolerance and packaging code.

Ex : LCN0805T-R10NJ-S

Tolerance : J = 5% , K = 10% , M = 20%

Packaging : Clear Tape and Reel (Standard)

L, Q, RDC : HP4287A

SRF : HP8753D / E4991A

Operating Temperature Range -40°C to +125°C



WOUND CHIP INDUCTORS LCN1008 SERIES

"LCN" series chip inductors have been designed especially for the needs of today's high frequency designer.

Their ceramic construction delivers the highest possible SRFs as well as excellent Q values.

The non-magnetic coil form also assures the utmost in thermal stability, predictability and batch consistency.

Color Coding

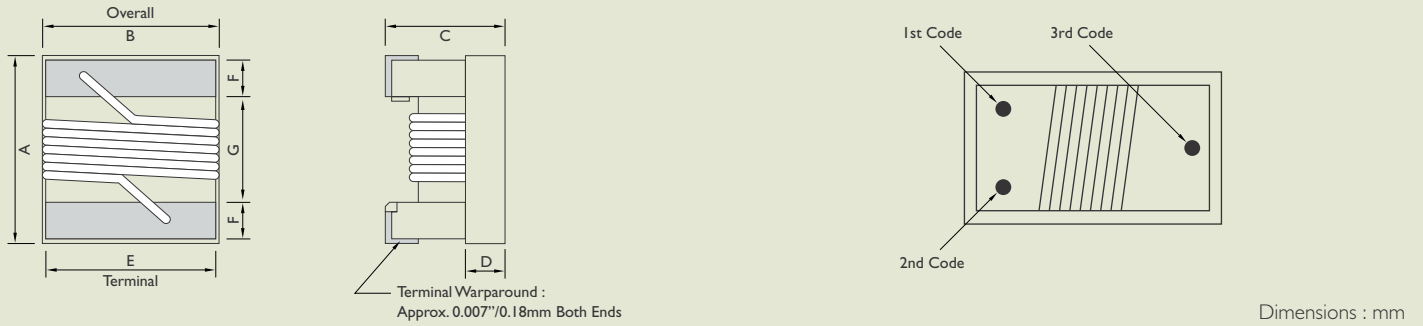

UNIT	A Max.	B Max.	C Max.	D Ref.	E	F	G
in	0.115	0.11	0.08	0.02	0.08	0.02	0.06
mm	2.92	2.79	2.10	0.51	2.03	0.51	1.52

Test Instruments : E4991A Impedance / Material Analyzer

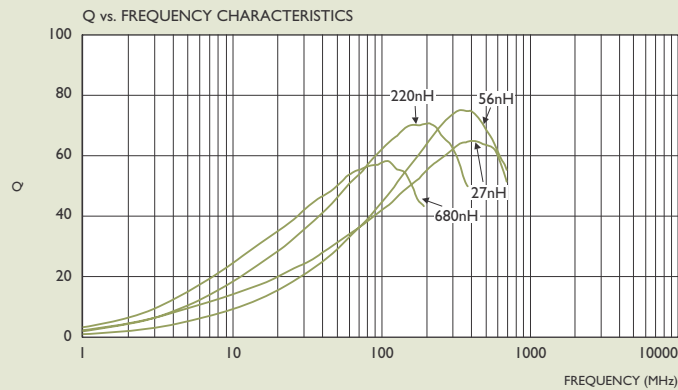
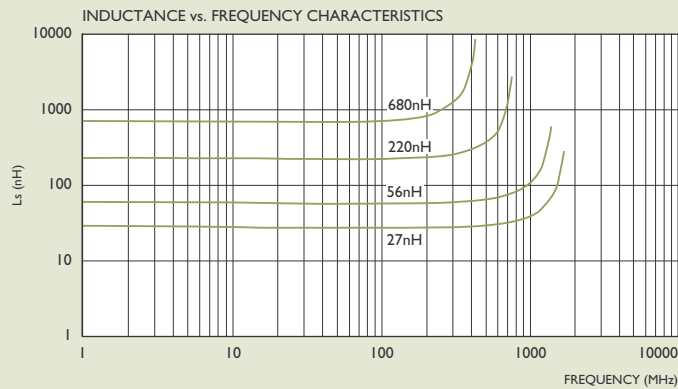



ELECTRICAL CHARACTERISTICS LCN1008 SERIES

PART NO.	INDUCTANCE at 50MHz (nH)	TOLERANCE (±%)	Q Min.	TEST FREQUENCY (MHz)	SRF (MHz) Min.	DC RESISTANCE (Ω) Max.	RATED CURRENT (mA) Max.	COLOR CODING		
								1 st	2 nd	3 rd
LCN1008T-10NK-S	10	10	50	500	4100	0.08	1000	Brown	Black	Black
LCN1008T-12NK-S	12	10	50	500	3300	0.09	1000	Brown	Red	Black
LCN1008T-15NK-S	15	10	50	500	2500	0.10	1000	Brown	Green	Black
LCN1008T-18NK-S	18	10	50	350	2500	0.11	1000	Brown	Gray	Black
LCN1008T-22NJ-S	22	5	55	350	2400	0.12	1000	Red	Red	Black
LCN1008T-27NJ-S	27	5	55	350	1600	0.13	1000	Red	Violet	Black
LCN1008T-33NJ-S	33	5	60	350	1600	0.14	1000	Orange	Orange	Black
LCN1008T-39NJ-S	39	5	60	350	1500	0.15	1000	Orange	White	Black
LCN1008T-47NJ-S	47	5	65	350	1500	0.16	1000	Yellow	Violet	Black
LCN1008T-56NJ-S	56	5	65	350	1300	0.18	1000	Green	Blue	Black
LCN1008T-68NJ-S	68	5	65	350	1300	0.20	1000	Blue	Gray	Black
LCN1008T-82NJ-S	82	5	60	350	1000	0.22	1000	Gray	Red	Black
LCN1008T-R10J-S	100 *	5	60	350	1000	0.56	650	Brown	Black	Brown
LCN1008T-R12J-S	120 *	5	60	350	950	0.63	650	Brown	Red	Brown
LCN1008T-R15J-S	150 *	5	45	100	850	0.70	580	Brown	Green	Brown
LCN1008T-R18J-S	180 *	5	45	100	750	0.77	620	Brown	Gray	Brown
LCN1008T-R22J-S	220 *	5	45	100	700	0.84	500	Red	Red	Brown
LCN1008T-R27J-S	270 *	5	45	100	600	0.91	500	Red	Violet	Brown
LCN1008T-R33J-S	330 *	5	45	100	570	1.05	450	Orange	Orange	Brown
LCN1008T-R39J-S	390 *	5	45	100	500	1.12	470	Orange	White	Brown
LCN1008T-R47J-S	470 *	5	45	100	450	1.19	470	Yellow	Violet	Brown
LCN1008T-R56J-S	560 *	5	45	100	415	1.33	400	Green	Blue	Brown
LCN1008T-R62J-S	620 *	5	45	100	375	1.40	300	Blue	Red	Brown
LCN1008T-R68J-S	680 *	5	45	100	375	1.47	400	Blue	Gray	Brown
LCN1008T-R75J-S	750 *	5	45	100	360	1.54	360	Violet	Green	Brown
LCN1008T-R82J-S	820 *	5	45	100	350	1.61	400	Gray	Red	Brown
LCN1008T-R91J-S	910 *	5	35	50	320	1.68	380	White	Brown	Brown
LCN1008T-1R0J-S	1000 *	5	35	50	220	1.75	370	Brown	Black	Red
LCN1008T-1R2J-S	1200 **	5	35	50	186	2.0	310	Brown	Red	Red
LCN1008T-1R5J-S	1500 **	5	28	50	200	2.3	330	Brown	Green	Red
LCN1008T-1R8J-S	1800 **	5	25	50	170	2.6	300	Brown	Gray	Red
LCN1008T-2R2J-S	2200 **	5	20	50	110	2.8	280	Red	Red	Red
LCN1008T-2R7J-S	2700 **	5	15	25	140	3.2	290	Red	Violet	Red
LCN1008T-3R3J-S	3300 **	5	15	25	100	3.4	290	Orange	Orange	Red
LCN1008T-3R9J-S	3900 **	5	15	25	100	3.6	260	Orange	White	Red
LCN1008T-4R7J-S	4700 **	5	13	25	90	4.0	260	Yellow	Violet	Red
LCN1008T-5R6J-S	5600 **	5	16	7.9	20	4.0	240	Green	Yellow	Red
LCN1008T-6R8J-S	6800 **	5	18	7.9	40	4.9	200	Yellow	Gray	Red
LCN1008T-8R2J-S	8200 **	5	18	7.9	25	6.0	170	Gray	Red	Red

Note : * at 25MHz ** at 7.9MHz

When ordering, please specify tolerance and packaging code.

Ex : LCN0805T-R10NJ-S

Tolerance : G = 2% , J = 5% , K = 10%

Packaging : Clear Tape and Reel (Standard)

L, Q : HP4287A SRF : HP8753D / E4991A

RDC : Digital Multimeter SC-7401

Operating Temperature Range -40°C to +125°C



COLOR CODING

LCN0603 & 0805 Series

Due to the small size of the chip inductor, the component will not be marked with three color dots.

Instead, there is only one color dot which represents an inductance value in nanohenries:

0603 SERIES

Color	nH
Black	1.8
Brown	3.9
Red	6.8
Orange	10
Yellow	12
Green	15
Blue	18
Violet	22
Gray	27
White	33
Black	39
Brown	47
Red	56
Orange	68
Yellow	72
Green	82
Blue	100
Violet	110
Gray	120

0805 SERIES

Color	nH
Black	3.3
Brown	6.8
Red	8.2
Orange	12
Yellow	15
Green	18
Blue	22
Violet	27
Gray	33
White	39
Black	47
Brown	56
Red	68
Orange	82
Yellow	100
Green	120
Blue	150
Violet	180
Gray	220
White	270
Black	330
Brown	390

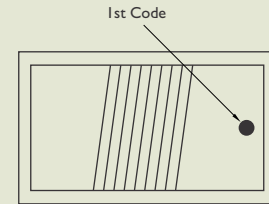

LCN1008 SERIES

These parts are marked with 3 color dots.

Each color dots show inductance in nanohenries.

0 = Black

1 = Brown

2 = Red

3 = Orange

4 = Yellow

5 = Green

6 = Blue

7 = Violet

8 = Gray

9 = White

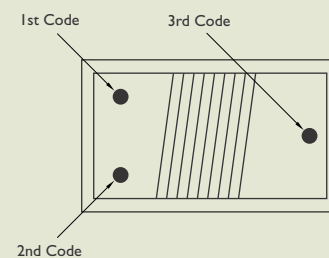



TAPE DIMENSIONS

Dimensions : mm

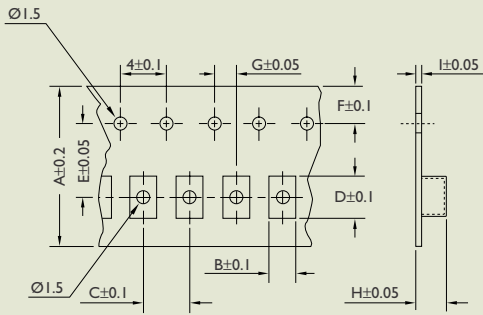

TAPE	A	B	C	D	E	F	G	H	I
LCN0603	8	1.1	4	1.75	3.5	1.75	2	1.15	0.25
LCN0805	8	1.88	4	2.38	3.5	1.75	2	1.48	0.2
LCN1008	8	2.73	4	2.88	3.5	1.75	2	2.33	0.2

TAPE MATERIAL

Carrier Tape : Polystyrene

Cover Type : Polyethylene

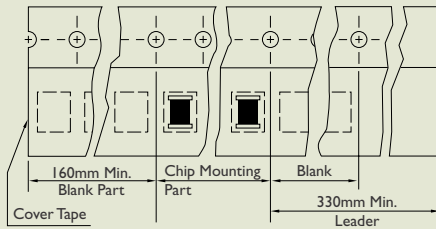

PACKAGING QUANTITY

Dimensions : mm

TYPE	QUANTITY/REEL
LCN0603	4000
LCN0805	2500
LCN1008	2000

REEL DIMENSIONS

Dimensions : mm

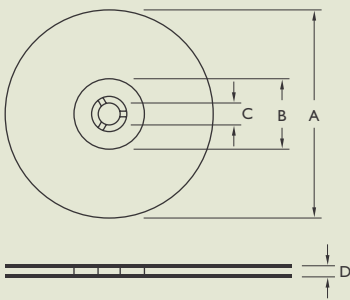

TAPE	REEL DIMENSIONS			
	A	B	C	D
LCN0603	178	60	13	9
LCN0805	178	60	13	9
LCN1008	178	60	13	9

RECOMMENDED PATTERN

Dimensions : mm

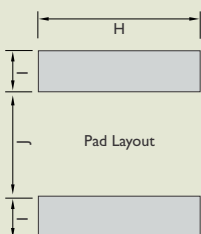

TYPE	UNIT	H	I	J
LCN0603	in	0.040	0.025	0.025
	mm	1.02	0.64	0.64
LCN0805	in	0.07	0.04	0.03
	mm	1.78	1.02	0.76
LCN1008	in	0.10	0.04	0.05
	mm	2.54	1.02	1.27



LCN SERIES RELIABILITY TEST

I-1 MECHANICAL PERFORMANCE

NO.	ITEM	SPECIFICATION	TEST CONDITIONS
I-1-1	Vibration	Appearance : No Damage L Change : within $\pm 10\%$ Q Change : within $\pm 30\%$	Test device shall be soldered on the substrate. Oscillation Frequency : 10 to 55 to 10Hz for 1Min. Amplitude : 1.5mm Time : 2Hrs. for each Axis (X, Y & Z), Total 6Hrs.
I-1-2	Resistance to Soldering Heat	Appearance : No Damage	Pre-heating : 150°C, 1Min. Solder Composition : Sn/Pb = 63/37 Solder Temperature : $260 \pm 5^\circ\text{C}$ Immersion Time : 10 ± 1 Sec.
I-1-3	Solderability	The electrodes shall be at least 90% covered with new solder coating.	Pre-heating : 150°C, 1Min. Solder Composition : Sn/Pb = 63/37 Solder Temperature : $230 \pm 5^\circ\text{C}$ Immersion Time : 4 ± 1 Sec.

I-2 ENVIRONMENTAL PERFORMANCE

NO.	ITEM	SPECIFICATION	TEST CONDITIONS															
I-2-1	Temperature Cycle	Appearance : No Damage L Change : within $\pm 10\%$ Q Change : within $\pm 30\%$	One Cycle <table border="1"> <thead> <tr> <th>Step</th> <th>Temperature (°C)</th> <th>Time (Min.)</th> </tr> </thead> <tbody> <tr> <td>1</td> <td>-25 ± 3</td> <td>30</td> </tr> <tr> <td>2</td> <td>25 ± 2</td> <td>3</td> </tr> <tr> <td>3</td> <td>85 ± 3</td> <td>30</td> </tr> <tr> <td>4</td> <td>25 ± 2</td> <td>3</td> </tr> </tbody> </table> Total : 100 Cycles Measured after Exposure in the Room Condition for 24Hrs.	Step	Temperature (°C)	Time (Min.)	1	-25 ± 3	30	2	25 ± 2	3	3	85 ± 3	30	4	25 ± 2	3
Step	Temperature (°C)	Time (Min.)																
1	-25 ± 3	30																
2	25 ± 2	3																
3	85 ± 3	30																
4	25 ± 2	3																
I-2-2	Humidity Resistance		Temperature : $40 \pm 2^\circ\text{C}$ Relative Humidity : 90 ~ 95% Time : 1000Hrs. Measured after Exposure in the Room Condition for 24Hrs.															
I-2-3	High Temperature Resistance		Temperature : $85 \pm 3^\circ\text{C}$ Relative Humidity : 20% Applied Current : Rated Current Time : 1000Hrs. Measured after Exposure in the Room Condition for 24Hrs.															
I-2-4	Low Temperature Resistance		Temperature : $-25 \pm 3^\circ\text{C}$ Relative Humidity : 0% Time : 1000Hrs. Measured after Exposure in the Room Condition for 24Hrs.															

DIP Power Inductors

PMC Series

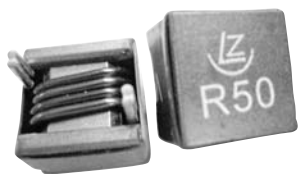

Features

- Magnetic shielded construction for high density board assembly
- High performance excellent DC current characteristics
- Large energy storage capacity
- Up to 40 amps continuous
- Custom designs available

PRODUCT IDENTIFICATION

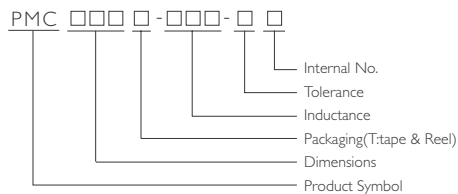

SHAPE AND DIMENSIONS

PMC129

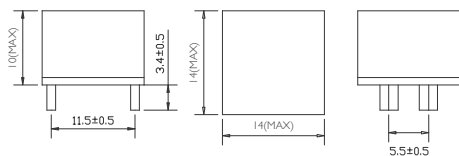

PMC127

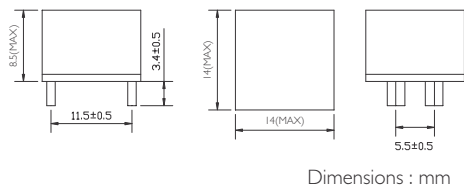

ELECTRICAL CHARACTERISTICS PMC SERIES

PART NO.	INDUCTANCE at (μH)	TOLERANCE (±%)	TEST FREQUENCY (KHZ)	SER (KHZ) MIN.	DC RESISTANCE (mΩ)MAX	RATED CURRENT (A)MIN
PMC129B-R30M-S	0.30	20%	100		0.8	60
PMC129B-R50M-S	0.50	20%	100		1.0	40
PMC129B-R60M-S	0.60	20%	100		1.0	40
PMC129B-R90M-S	0.90	20%	100		1.8	30
PMC129B-1R2M-S	1.20	20%	100		2.0	30
PMC129B-1R5M-S	1.50	20%	100		2.2	25
PMC129B-2R2M-S	2.20	20%	100		3.0	20
PMC129B-3R3M-S	3.30	20%	100		3.0	15
PMC129B-4R7M-S	4.70	20%	100		5.0	15
PMC127B-R60M-S	0.60	20%	100		1.0	30
PMC127B-1R0M-S	1.00	20%	100		2.0	30
PMC127B-1R5M-S	1.50	20%	100		2.0	25
PMC127B-2R2M-S	2.20	20%	100		3.0	20
PMC127B-3R3M-S	3.30	20%	100		4.5	20

Note: * at 25MHZ ** at 7.9MHZ

When ordering please specify tolerance and packaging code.

Ex : PMC129- R60M-S Tolerance: M±20%, L± 15%, K± 10% Packaging: Clear Tape and Reel (Standard)

L Q :HP4287A SRF :HP8753D/E4991A RDC: Digital Multimeter SC-740I

Operating Temperature °C Range -40°C to +125°C

Lay OUT

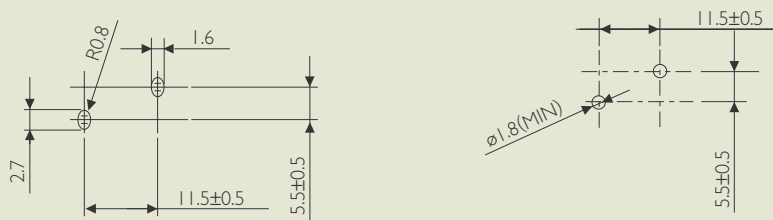

SMT Power Inductors

SPMC Series

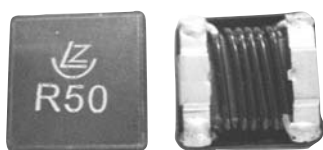

PRODUCT IDENTIFICATION

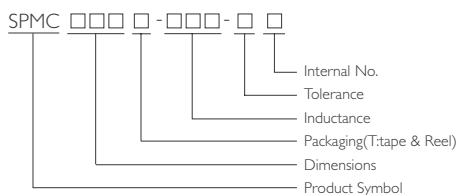

SHAPE AND DIMENSIONS

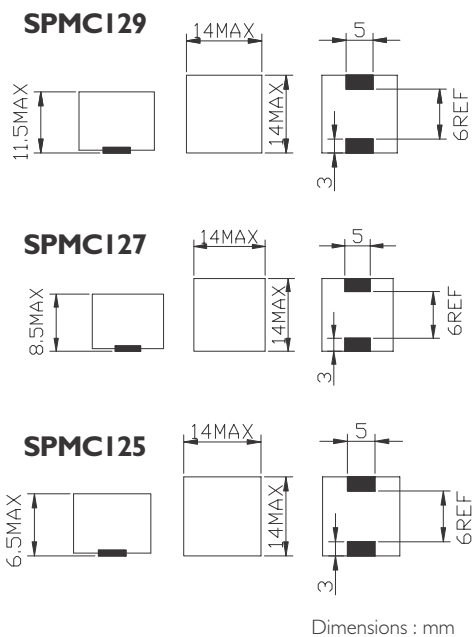

Features

- Magnetic shielded construction for high density board assembly
- High performance excellent DC current characteristics
- Large energy storage capacity
- Up to 40 amps continuous
- Custom designs available

ELECTRICAL CHARACTERISTICS SPMC SERIES

PART NO.	INDUCTANCE at (μH)	TOLERANCE (±%)	TEST FREQUENCY (KHZ)	SER (KHZ) MIN.	DC RESISTANCE (mΩ)MAX	RATED CURRENT (A)MIN
SPMC129T-R47M-S	0.47	20%	100		5.0	40
SPMC129T-R50M-S	0.50	20%	100		3.0	40
SPMC129T-1R0M-S	1.00	20%	100		2.8	30
SPMC129T-1R2M-S	1.20	20%	100		2.0	30
SPMC129T-1R5M-S	1.50	20%	100		2.0	25
SPMC129T-4R7M-S	1.70	20%	100		1.0	18
SPMC127T-R50M-S	0.50	20%	100		1.5	35
SPMC127T-R60M-S	0.60	20%	100		1.2	30
SPMC127T-1R0M-S	1.00	20%	100		2.0	30
SPMC127T-1R5M-S	1.50	20%	100		3.3	20
SPMC127T-4R7M-S	4.70	20%	100		8.0	15
SPMC125T-R50M-S	0.50	20%	100		1.8	30
SPMC125T-R60M-S	0.60	20%	100		1.8	30
SPMC125T-R80M-S	0.80	20%	100		2.0	30

Note: * at 25MHZ ** at 7.9MHZ

When ordering please specify tolerance and packaging code.

Ex : P129- R60M-S Tolerance: M±20%, L± 15%, K± 10% Packaging: Clear Tape and Reel (Standard)

L Q :HP4287A SRF :HP8753D/E4991A RDC: Digital Multimeter SC-7401

Operating Temperature °C Range -40°C to +125°C

DIP Power Inductors

MBPL Series



PRODUCT IDENTIFICATION

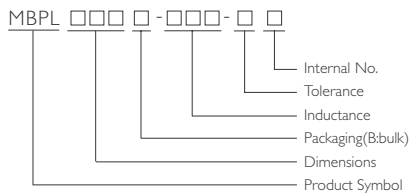

SHAPE AND DIMENSIONS

MBPL1319

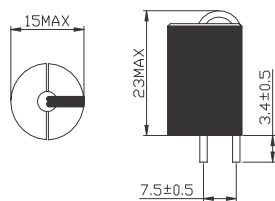

MBPL1220

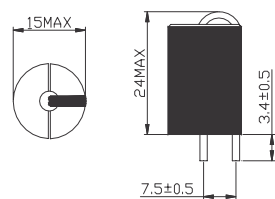

MBPL1217

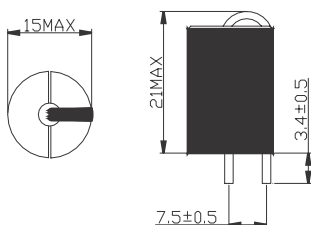

Dimensions : mm

Features

- Magnetic shielded construction for high density board assembly
- High performance excellent DC current characteristics
- Large energy storage capacity
- Up to 40 amps continuous
- Custom designs available

ELECTRICAL CHARACTERISTICS MBPL SERIES

PART NO.	INDUCTANCE at (μH)	TOLERANCE (±%)	TEST FREQUENCY (KHZ)	SER (KHZ) MIN.	DC RESISTANCE (mΩ)MAX	RATED CURRENT (A)MIN
MBPL1319B-R30M-S	0.30	20%	100		0.5	60
MBPL1319B-R60M-S	0.60	20%	100		1.0	60
MBPL1319B-R90M-S	0.90	20%	100		1.0	40
MBPL1319B-1R2M-S	1.20	20%	100		1.0	35
MBPL1220B-1R2M-S	1.20	20%	100		1.8	30
MBPL1220B-1R5M-S	1.50	20%	100		1.8	40
MBPL1217B-R30M-S	0.30	20%	100		0.7	45
MBPL1217B-R60M-S	0.60	20%	100		1.5	40
MBPL1217B-R90M-S	0.90	20%	100		1.5	30

Note: * at 25MHZ ** at 7.9MHZ

When ordering please specify tolerance and packaging code.

Ex : PMC129- R60M-S Tolerance: M±20%, L± 15%, K± 10% Packaging: Clear Tape and Reel (Standard)

L Q :HP4287A SRF :HP8753D/E4991A RDC: Digital Multimeter SC-7401

Operating Temperature °C Range -40°C to +125°C



TAPE DIMENSIONS

Dimensions : mm

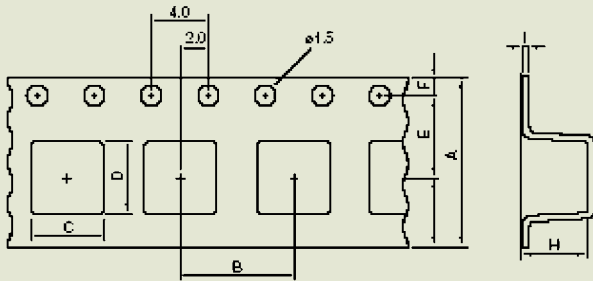

TAPE MATERIAL

Carrier Tape : Polystyrene

Cover Type : Polyethylene

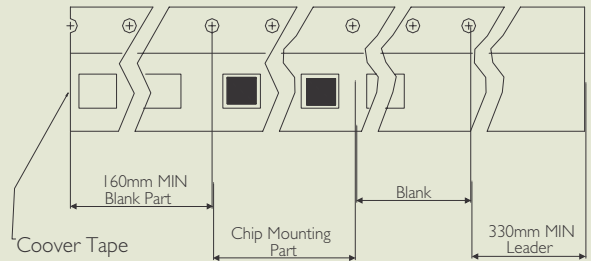

REEL DIMENSIONS

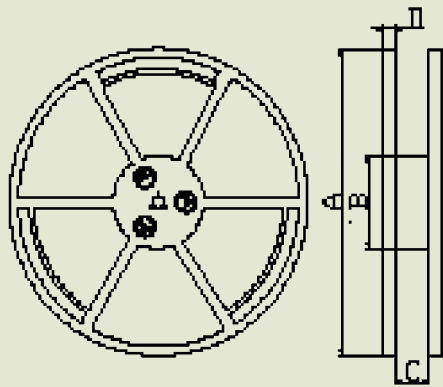

RECOMMENDED PATTERN

Land Pattern

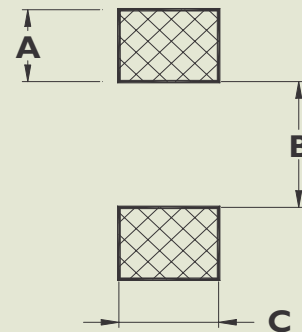

Dimensions : mm

TYPE	TAPE DIMENSIONS						REEL DIMENSIONS			RECOMMENDED PATTERN			QUANTITY /REEL
	A	B	C	D	E	H	A	B	C	A	B	C	
PMCI29	32	20	13.9	13.9	14.2	11.5	330	100	32.5	4	6	6.2	250
PMCI27	32	20	13.9	13.9	14.2	9	330	100	32.5	4	6	6.2	250
PMCI25	32	20	13.9	13.9	14.2	7	330	100	32.5	4	6	6.2	300



PMC SERIES RELIABILITY TEST

I-1 MECHANICAL PERFORMANCE

NO.	ITEM	SPECIFICATION	TEST CONDITIONS
I-1-1	Vibration	Appearance :No Damage L Change :within±10% Q Change :within±30% RDC:within Specificadion	Test device shall solderd on the substrate Oscillation frequency:10 to 50 to 10HZ for IMin Amplitude : 1.5mm Time :2Hrs,for each Axis (X,Y&Z),Total 6Hrs
I-1-2	Resistance to Soldering Heat	Appearance :No Damage	Pre-heating: 150°C , IMin. Solder Composition: Sn/Pb=63/37 Solder Temperature: 260±5°C Immersion Time: 10± ISec.
I-1-3	Solderability	The electrodes shall be at least 90% covered with new solder coating.	Pre-heating: 150°C , IMin. Solder Composition: Sn/Pb=63/37 Solder Temperature: 230±5°C Immersion Time: 4± ISec.

I-2 ENVIRONMENTAL PERFORMANCE

NO	ITEM	SPECIFICATION	TEST CONDITIONS															
I-2-1	Temperature Shock	Appearance: No Damage L Change: within ± 10% L Change: within ± 30% RDC: within Speciflcation	10 Cycles (Air to Air) I Cycles shall Consist of: 30Min.Exposure to -55°C 30Min.Exposure to -125°C 15Sec.Max.Transition between Temperatures Measured after Exposure in the Room Condition for 24Hrs.															
I-2-2	Temperature Cycle		One Cycle <table border="1"> <thead> <tr> <th>Step</th> <th>Temperature(°C)</th> <th>Time (Min.)</th> </tr> </thead> <tbody> <tr> <td>1</td> <td>-25±3</td> <td>30</td> </tr> <tr> <td>2</td> <td>25±2</td> <td>3</td> </tr> <tr> <td>3</td> <td>85±3</td> <td>30</td> </tr> <tr> <td>4</td> <td>25±2</td> <td>3</td> </tr> </tbody> </table> Total: 100Cycles Measured after Exposure in the Room Condition for 24Hrs.	Step	Temperature(°C)	Time (Min.)	1	-25±3	30	2	25±2	3	3	85±3	30	4	25±2	3
Step	Temperature(°C)	Time (Min.)																
1	-25±3	30																
2	25±2	3																
3	85±3	30																
4	25±2	3																
I-2-3	Humidity Resistance		Temperature: 40±2°C Relative Humidity: 90~95% Time: 1000Hrs. Measured after Exposure in the Room Condition for 24Hrs.															
I-2-4	High Temperature Resistance		Temperature: 85±3°C Relative Humidity: 20% Applied Current: Rated Current Time: 1000Hrs. Measured after Exposure in the Room Condition for 24Hrs.															
I-2-5	Low Temperature Resistance		Temperature: -25±3°C Relative Humidity: 0% Time: 1000Hrs. Measured after Exposure in the Room Condition for 24Hrs.															

Mini Power Inductors

GAB0312 Series

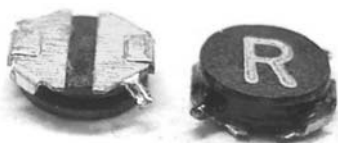

Features

- Low profile 1.2mm max.
- Maximum current rating of 1.4Amps.
- Density design, small size, and low cost.

Applications

- DC /DC converter
- Camcorder
- LCD TV
- MP3 - player
- Digital camera
- G.P.S
- Portable CDR-W
- PDA (desktop)

PRODUCT IDENTIFICATION

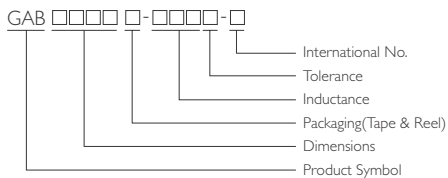

TYPICAL ELECTRICAL CHARACTERISTICS CURVE

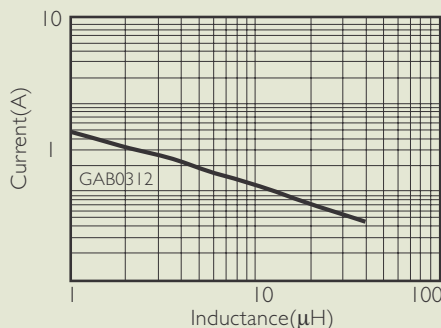

TEST INSTRUMENT: HP 4285A, Zentech 301A
INDUCTANCE-CURRENT (REFERENCE)

ELECTRICAL CHARACTERISTICS

P/N	Inductance L(µH) ¹	DCR (Ω) ±20%	IDC (A) MAX. ²	Marking
GAB0312T-1R0N-S	1.0±30%	0.08	1.40	A
GAB0312T-1R8N-S	1.8±30%	0.11	1.10	C
GAB0312T-2R2N-S	2.2±30%	0.12	1.00	D
GAB0312T-2R7N-S	2.7±30%	0.15	0.95	E
GAB0312T-4R7N-S	4.7±30%	0.28	0.75	H
GAB0312T-5R6N-S	5.6±30%	0.31	0.68	I
GAB0312T-6R8N-S	6.8±30%	0.36	0.62	K
GAB0312T-7R5N-S	7.5±30%	0.39	0.60	L
GAB0312T-100M-S	10±20%	0.43	0.53	M
GAB0312T-150M-S	15±20%	0.72	0.44	O
GAB0312T-220M-S	22±20%	1.18	0.33	R
GAB0312T-330M-S	33±20%	1.90	0.26	T
GAB0312T-470M-S	47±20%	2.45	0.23	V
GAB0312T-680M-S	68±20%	4.20	0.17	X

1. Test Frequency 100KHZ 0.1Vrms.
2. DC Current at which the Inductance Drops 30%(typ) from its value without Current.
3. Operating Temperature Range -40°C to 85°C
4. Tolerance : M : ±20% , N : ±30%
5. Packaging : Clear Tape and Reel (Standard)

SHAPE AND DIMENSIONS

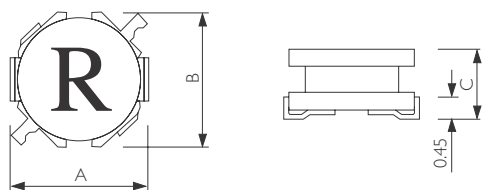

TYPE	A	B	C
GAB0312	3.2±0.3	3.2±0.3	1.2MAX

Dimensions : mm

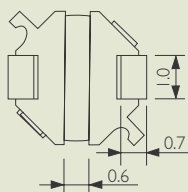

Parts/reel:
7" 1500pcs

Tape width:
12mm

LAND PATTERNS PCB

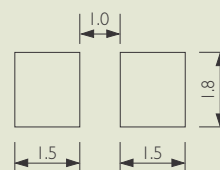

Mini Power Inductors

NDA Series

(NDA0715)



Features

- Excellent property with high saturation for surface mounting
- Magnetically shielded & low radiation.
- Large rated current 2.5A max.
- low profile less than 1.5mm.

Applications

- DC-DC converter
- LCD monitor
- Digital video and still cameras.
- Digital camera.
- Harddisk drivers and others.

PRODUCT IDENTIFICATION

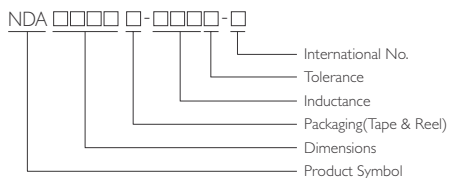

ELECTRICAL CHARACTERISTICS

P/N	Inductance L(μ H) $\pm 20^1$	DCR (Ω) MAX.	IDC (A) MAX. ²
NDA0715T-1R6□-S	1.60	0.045	2.50
NDA0715T-2R2□-S	2.20	0.065	2.00
NDA0715T-2R6□-S	2.60	0.075	1.80
NDA0715T-3R0□-S	3.00	0.085	1.70
NDA0715T-3R3□-S	3.30	0.096	1.60
NDA0715T-3R6□-S	3.60	0.110	1.50
NDA0715T-4R7□-S	4.70	0.130	1.30
NDA0715T-470□-S	47.0	0.650	0.45

1. Test Frequency 100KHZ / 0.1Vrms.
2. DC current at which the Inductance drops 20%(typ) from its value without current.
3. Operating Temperature Range -40°C to 85°C
4. Tolerance : M : 20% , N : 30%
5. Packaging : ClearTape and Reel (Standard)

SHAPE AND DIMENSIONS

Dimensions : mm

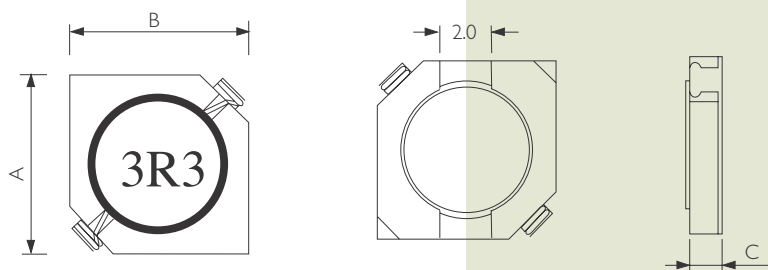

LAND PATTERNS PCB

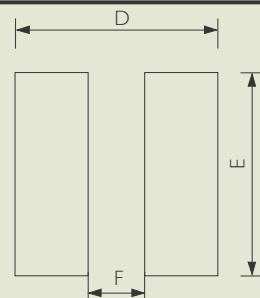

TYPE	A	B	C	D	E	F
NDA0715	7.0 \pm 0.2	7.0 \pm 0.2	1.5MAX	7.3	7.3	2.0

Mini Power Inductors

NDA Series

(NDA1015)



Features

- Excellent property with high saturation for surface mounting
- Magnetically shielded & low radiation.
- Large rated current 3.0A max.
- low profile less than 1.5mm.

Applications

- DC-DC converter
- LCD monitor
- Digital video and still cameras.
- Digital camera.
- Harddisk drivers and others.

PRODUCT IDENTIFICATION

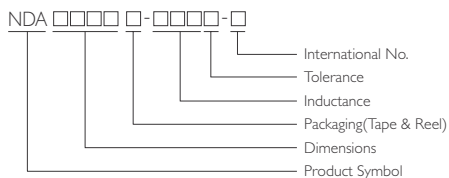

ELECTRICAL CHARACTERISTICS

P/N	Inductance L(μH)±20 ¹	DCR (Ω) MAX.	IDC (A) MAX. ²
NDA0715T-1R6□-S	1.60	0.045	2.50
NDA0715T-2R2□-S	2.20	0.065	2.00
NDA0715T-2R6□-S	2.60	0.075	1.80
NDA0715T-3R0□-S	3.00	0.085	1.70
NDA0715T-3R3□-S	3.30	0.096	1.60
NDA0715T-3R6□-S	3.60	0.110	1.50
NDA0715T-4R7□-S	4.70	0.130	1.30
NDA0715T-470□-S	47.0	0.650	0.45

1. Test Frequency 100KHZ / 0.1Vrms.
2. DC current at which the Inductance drops 20%(typ) from its value without current.
3. Operating Temperature Range -40°C to 85°C
4. Tolerance : M : 20% , N : 30%
5. Packaging : ClearTape and Reel (Standard)

SHAPE AND DIMENSIONS

Dimensions : mm

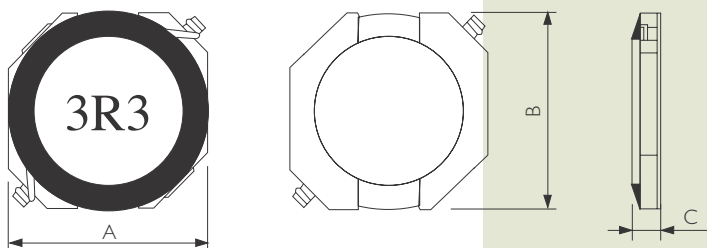

TYPE	A	B	C	D	E	F
NDA1015	10.3MAX	10.3MAX	1.5MAX	10.4	10.4	3.0

LAND PATTERNS PCB

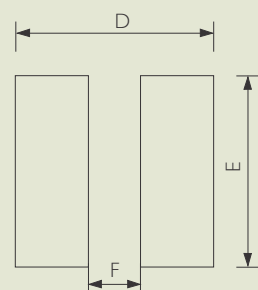

Mini Power Inductors

NAN Series

(NAN0610)

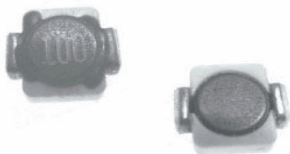

Features

- Very low profile.
- Constructed enclosed in a rugged to provide optimum pick and place operations.
- High inductance & high current ultra low profile power inductors.

Applications

- DC to DC converter
- LCD
- Mobile telephone

PRODUCT IDENTIFICATION

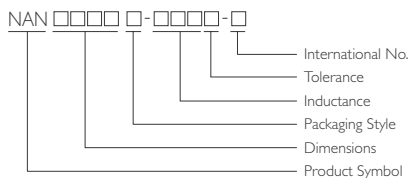

ELECTRICAL CHARACTERISTICS

TYPE	Inductance L(μH) ¹	DCR (Ω) MAX.	IDC (mA) MAX. ²
NAN0610T-1R2M-S	1.20	0.08	2100
NAN0610T-1R5M-S	1.50	0.10	1900
NAN0610T-2R2M-S	2.20	0.12	1600
NAN0610T-3R3M-S	3.30	0.16	1300
NAN0610T-4R7M-S	4.70	0.20	1100
NAN0610T-6R8M-S	6.80	0.32	900
NAN0610T-100M-S	10.0	0.41	800
NAN0610T-150M-S	15.0	0.55	650
NAN0610T-220M-S	22.0	0.85	500
NAN0610T-330M-S	33.0	1.30	400
NAN0610T-470M-S	47.0	1.80	350
NAN0610T-680M-S	68.0	2.50	300
NAN0610T-101M-S	100	3.50	250
NAN0610T-151M-S	150	5.00	180
NAN0610T-221M-S	220	7.00	160
NAN0610T-331M-S	330	15.0	130

1. Test Frequency 100KHZ / 0.1Vrms.
2. DC current at which the Inductance drops 10%(typ) from its value without current.
3. Operating Temperature Range -40°C to 85°C
4. Electrical specification at 25°C
5. Inductance : M : ±20%

SHAPE AND DIMENSIONS

Dimensions : mm

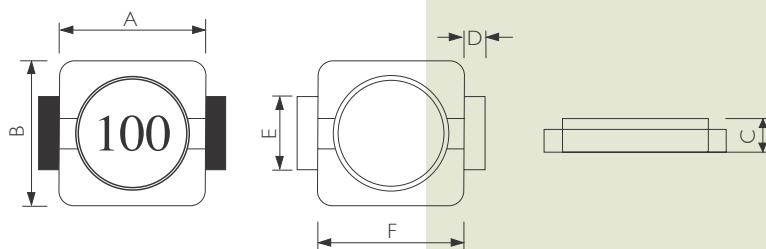

LAND PATTERNS PCB

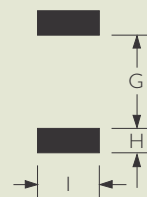

TYPE	A	B	C	D	E	F	G	H	I
NAN0610	6.5MAX	5.3±0.3	1.0MAX	0.9	3.0	4.5	4.0	1.0	2.3

Mini Power Inductors

NAN Series

(NAN0612)

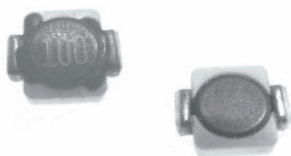

Features

- Very low profile.
- Constructed enclosed in a rugged to provide optimum pick and place operations.
- High inductance & high current ultra low profile power inductors.

Applications

- DC to DC converter
- LCD
- Mobile telephone

PRODUCT IDENTIFICATION

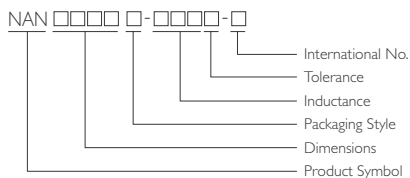

ELECTRICAL CHARACTERISTICS

TYPE	Inductance L(μH) ¹	DCR (Ω) MAX.	IDC (mA) MAX. ²
NAN0612T-1R2M-S	1.20	0.060	1800
NAN0612T-2R2M-S	2.20	0.125	1200
NAN0612T-3R3M-S	3.30	0.155	960.0
NAN0612T-4R7M-S	4.70	0.206	900.0
NAN0612T-6R8M-S	6.80	0.240	800.0
NAN0612T-100M-S	10.0	0.370	700.0
NAN0612T-150M-S	15.0	0.460	600.0
NAN0612T-180M-S	18.0	0.580	560.0
NAN0612T-220M-S	22.0	0.668	500.0
NAN0612T-270M-S	27.0	0.950	450.0
NAN0612T-330M-S	33.0	1.100	420.0
NAN0612T-390M-S	39.0	1.280	380.0
NAN0612T-470M-S	47.0	1.380	340.0
NAN0612T-560M-S	56.0	1.700	300.0
NAN0612T-680M-S	68.0	2.100	280.0
NAN0612T-820M-S	82.0	2.700	260.0
NAN0612T-101M-S	100.0	3.100	235.0

1. Test Frequency 100KHZ / 0.1Vrms.
2. DC current at which the Inductance drops 10%(typ) from its value without current.
3. Operating Temperature Range -40°C to 85°C
4. Electrical specification at 25°C
5. Inductance : M : ±20%

SHAPE AND DIMENSIONS

Dimensions : mm

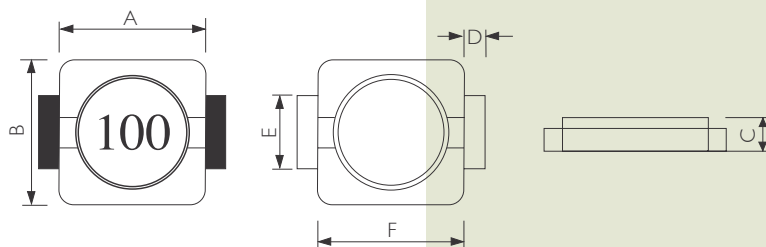

LAND PATTERNS PCB



TYPE	A	B	C	D	E	F	G	H	I
NAN0612	6.6	5.3±0.3	1.2	0.9	3.0	4.5	4.0	1.0	2.3

Mini Power Inductors

NAN Series

(NAN0620)

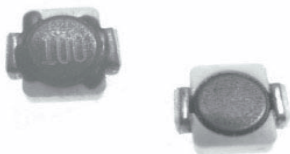

Features

- Very low profile.
- Constructed enclosed in a rugged to provide optimum pick and place operations.
- High inductance & high current ultra low profile power inductors.

Applications

- DC to DC converter
- LCD
- Mobile telephone

PRODUCT IDENTIFICATION

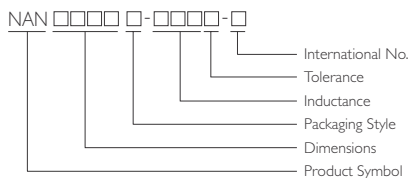

ELECTRICAL CHARACTERISTICS

TYPE	Inductance L(μ H) ¹	DCR (Ω) MAX.	IDC (mA) MAX. ²
NAN0620T-1R0M-S	1.00	0.04	2500
NAN0620T-1R5M-S	1.50	0.06	2200
NAN0620T-2R2M-S	2.20	0.07	1800
NAN0620T-3R3M-S	3.30	0.11	1400
NAN0620T-4R7M-S	4.70	0.12	1200
NAN0620T-6R8M-S	6.80	0.19	1100
NAN0620T-100M-S	10.0	0.30	1000
NAN0620T-150M-S	15.0	0.40	800
NAN0620T-220M-S	22.0	0.54	600
NAN0620T-330M-S	33.0	0.74	500
NAN0620T-470M-S	47.0	1.10	450
NAN0620T-680M-S	68.0	1.60	350
NAN0620T-101M-S	100	2.30	300
NAN0620T-151M-S	150	3.20	250
NAN0620T-221M-S	220	5.70	200
NAN0620T-331M-S	330	8.20	160
NAN0620T-471M-S	470	10.8	140
NAN0620T-681M-S	680	17.2	120
NAN0620T-102M-S	100.0	22.6	80

1. Test Frequency 100KHZ / 0.1Vrms.

2. DC current at which the Inductance drops 10%(typ) from its value without current.

3. Operating Temperature Range -40°C to 85°C

4. Electrical specification at 25°C

5. Inductance : M : $\pm 20\%$

SHAPE AND DIMENSIONS

Dimensions : mm

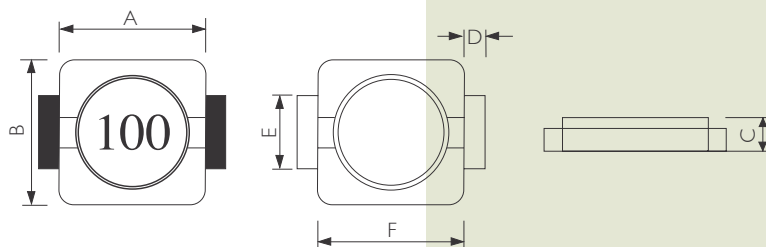

LAND PATTERNS PCB

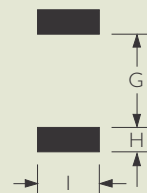

TYPE	A	B	C	D	E	F	G	H	I
NAN0620	6.5MAX	5.3 \pm 0.3	2.0MAX	0.9	3.0	4.5	4.0	1.0	2.3

SMD Power Inductors

NAS Series

(NAS0615)



Features

- Magnetically shielded and low radiation
- Very low DCR & better Q factor
- Flat bottom for reliable surface mounting
- Density design, small size, and low cost

Applications

- Mobile telephone.
- Step-up or step-down converters.
- Flash memory.

PRODUCT IDENTIFICATION

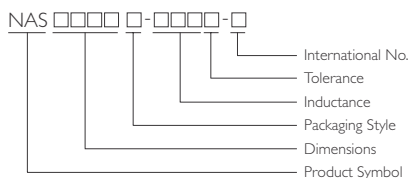

ELECTRICAL CHARACTERISTICS

TYPE	Inductance L(μH)±20 ¹	DCR (Ω) MAX.	IDC (A) MAX. ²
NAS0615T-1R6M-S	1.6	0.045	2.5
NAS0615T-2R2M-S	2.2	0.065	2.0
NAS0615T-2R6M-S	2.6	0.075	1.8
NAS0615T-3R0M-S	3.0	0.085	1.7
NAS0615T-3R3M-S	3.3	0.096	1.6
NAS0615T-3R6M-S	3.6	0.110	1.5
NAS0615T-4R7M-S	4.7	0.130	2.0

1. Test Frequency 100KHZ / 0.1Vrms.
2. Inductance drops 20%(typ) at rated Isat.
3. Operating Temperature Range -40°C to 85°C
4. Inductance : M : ±20%

SHAPE AND DIMENSIONS

Dimensions : mm

LAND PATTERNS PCB

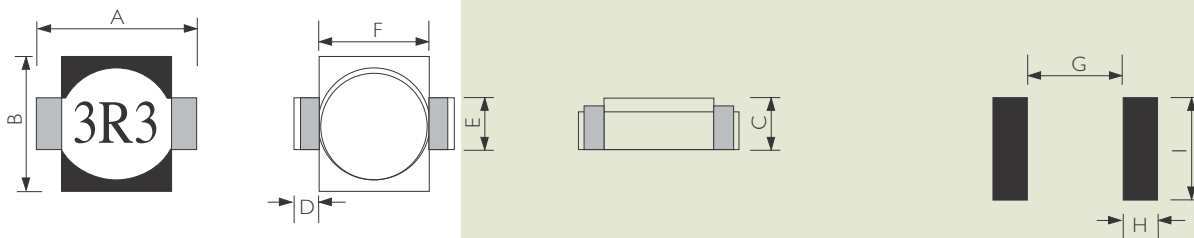

TYPE	A	B	C	D	E	F	G	H	I
NAS0615	6.50MAX	5.3±0.3	1.5MAX	0.9	2.6	4.5	4.06	1.40	3.56

SMD Power Inductors

NAS Series

(NAS0620)



Features

- Magnetically shielded and low radiation
- Very low DCR & better Q factor
- Flat bottom for reliable surface mounting
- Density design, small size, and low cost

Applications

- Mobile telephone.
- Step-up or step-down converters.
- Flash memory.

PRODUCT IDENTIFICATION

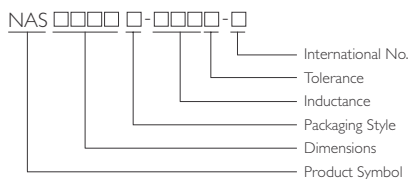

ELECTRICAL CHARACTERISTICS

TYPE	L(μ H) $\pm 20\%$ ¹	Q MIN	DCR (Ω) max	SRF typ(MHz)	IDC (A) MAX. ²
NAS0620T-1R0M-S	1.00	30 @200KHZ	0.040	250	3.00
NAS0620T-1R5M-S	1.50	30 @200KHZ	0.045	125	2.80
NAS0620T-2R2M-S	2.20	40 @200KHZ	0.05	120	1.80
NAS0620T-3R2M-S	3.30	40 @200KHZ	0.055	120	1.60
NAS0620T-4R7M-S	4.70	40 @200KHZ	0.060	105	1.40
NAS0620T-6R8M-S	6.80	40 @200KHZ	0.065	50	1.20
NAS0620T-100M-S	10.0	40 @200KHZ	0.075	38	1.00
NAS0620T-150M-S	15.0	40 @200KHZ	0.090	33	0.80
NAS0620T-220M-S	22.0	40 @200KHZ	0.110	25	0.70
NAS0620T-330M-S	33.0	40 @200KHZ	0.190	20	0.60
NAS0620T-470M-S	47.0	40 @200KHZ	0.230	20	0.50
NAS0620T-680M-S	68.0	40 @200KHZ	0.290	15	0.40
NAS0620T-101M-S	100	40 @200KHZ	0.480	10	0.30
NAS0620T-151M-S	150	40 @200KHZ	0.590	9	0.26
NAS0620T-221M-S	220	40 @200KHZ	0.770	6	0.22
NAS0620T-331M-S	330	40 @200KHZ	1.400	5	0.20
NAS0620T-471M-S	470	40 @200KHZ	1.800	4	0.19
NAS0620T-681M-S	680	40 @200KHZ	2.200	3	0.18
NAS0620T-102M-S	1000	40 @200KHZ	3.400	2	0.15
NAS0620T-152M-S	1500	50 @200KHZ	4.200	2	0.12
NAS0620T-222M-S	2200	50 @200KHZ	8.500	2	0.10
NAS0620T-332M-S	3300	50 @200KHZ	11.00	1	0.08
NAS0620T-472M-S	4700	50 @200KHZ	13.90	1	0.06
NAS0620T-682M-S	6800	50 @200KHZ	25.00	1	0.04
NAS0620T-103M-S	10000	50 @200KHZ	32.80	0.8	0.02

1. Inductance tested at 0.1Vrms, 100KHZ..

2. 30°C Temperature rise.

3. Operating Temperature Range -40°C to 85°C

4. Electrical specification at 25°C

5. Inductance : M : $\pm 20\%$

SHAPE AND DIMENSIONS

Dimensions : mm

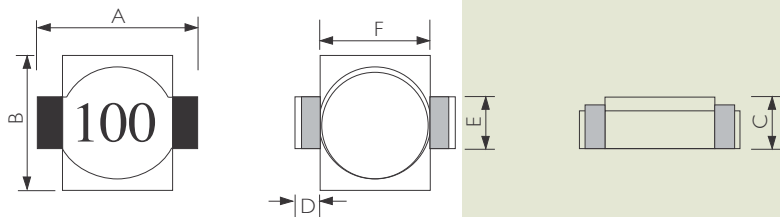

LAND PATTERNS PCB

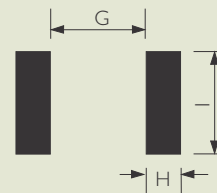

TYPE	A	B	C	D	E	F	G	H	I
NAS0620	6.50MAX	5.3 \pm 0.3	2.0MAX	0.9	2.6	4.5	4.06	1.40	3.56

SMD Power Inductors

NAS Series

(NAS0620BL)

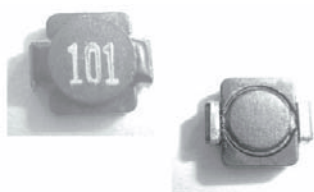

Features

- Magnetically shielded and low radiation
- Very low DCR & better Q factor
- Flat bottom for reliable surface mounting
- Density design, small size, and low cost

Applications

- Mobile telephone.
- Step-up or step-down converters.
- Flash memory.

PRODUCT IDENTIFICATION

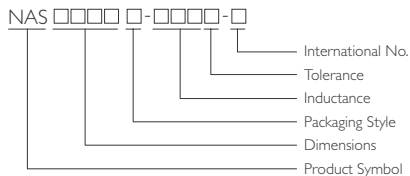

ELECTRICAL CHARACTERISTICS

TYPE	L(μH)±20% ¹	DCR (Ω) max	Insulation core-winding(MΩ)	SRF typ(MHz)	IDC (A) MAX. ²
NAS0620BLT-101M-S	0.10	0.95	>10	12	220
NAS0620BLT-151M-S	0.15	1.40	>10	10	200
NAS0620BLT-221M-S	0.22	1.70	>10	8	180
NAS0620BLT-331M-S	0.33	2.20	>10	6	160
NAS0620BLT-471M-S	0.47	3.80	>10	5	140
NAS0620BLT-681M-S	0.68	4.90	>10	4	120
NAS0620BLT-102M-S	1.00	9.00	>10	2	100
NAS0620BLT-152M-S	1.50	11.0	>10	1	80
NAS0620BLT-222M-S	2.20	19.0	>10	1	50
NAS0620BLT-332M-S	3.30	24.0	>10	1	40
NAS0620BLT-472M-S	4.70	30.0	>10	1	30
NAS0620BLT-682M-S	6.80	56.0	>10	0.9	20
NAS0620BLT-103M-S	10.0	74.0	>10	0.9	10

1. Inductance tested at 0.1Vrms, 100KHZ.
2. 30°C Temperature rise.
3. Operating Temperature Range -40°C to 85°C
4. Electrical specification at 25°C
5. Inductance : M : ±20%

SHAPE AND DIMENSIONS

Dimensions : mm

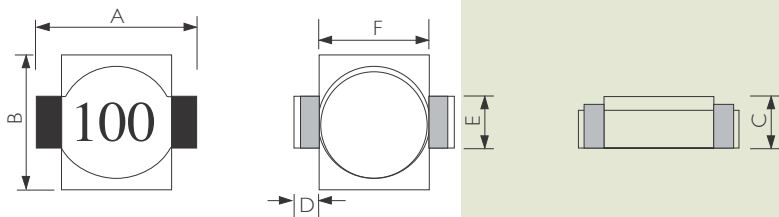

LAND PATTERNS PCB

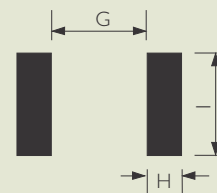

TYPE	A	B	C	D	E	F	G	H	I
NAS0620BL	6.50MAX	5.3±0.3	2.0MAX	0.9	2.6	4.5	4.06	1.40	3.56

SMD Power Inductors

NAS Series

(NAS0630)



Features

- Magnetically shielded and low radiation
- Very low DCR & better Q factor
- Flat bottom for reliable surface mounting
- Density design, small size, and low cost

Applications

- Mobile telephone.
- Step-up or step-down converters.
- Flash memory.

PRODUCT IDENTIFICATION

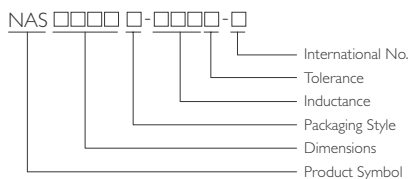

ELECTRICAL CHARACTERISTICS

TYPE	L(μ H) $\pm 20\%$ ¹	Q MIN	DCR (Ω) max	SRF typ(MHz)	IDC (A) MAX. ²
NAS0630T-1R0M-S	1.00	20 @200KHZ	0.042	250	3.00
NAS0630T-1R5M-S	1.50	30 @200KHZ	0.045	125	2.80
NAS0630T-2R2M-S	2.20	40 @200KHZ	0.050	120	1.80
NAS0630T-3R2M-S	3.30	40 @200KHZ	0.055	120	1.60
NAS0630T-4R7M-S	4.70	40 @200KHZ	0.060	105	1.40
NAS0630T-6R8M-S	6.80	40 @200KHZ	0.065	50	1.20
NAS0630T-100M-S	10.0	40 @200KHZ	0.075	38	1.00
NAS0630T-150M-S	15.0	40 @100KHZ	0.090	33	0.80
NAS0630T-220M-S	22.0	40 @100KHZ	0.110	25	0.70
NAS0630T-330M-S	33.0	40 @100KHZ	0.190	20	0.60
NAS0630T-470M-S	47.0	40 @100KHZ	0.230	20	0.50
NAS0630T-680M-S	68.0	40 @100KHZ	0.290	15	0.40
NAS0630T-101M-S	100	40 @100KHZ	0.480	10	0.30
NAS0630T-151M-S	150	40 @100KHZ	0.590	9	0.26
NAS0630T-221M-S	220	40 @100KHZ	0.770	6	0.22
NAS0630T-331M-S	330	40 @100KHZ	1.400	5	0.20
NAS0620T-471M-S	470	40 @100KHZ	1.800	4	0.19
NAS0630T-681M-S	680	40 @100KHZ	2.200	3	0.18
NAS0630T-102M-S	1000	40 @100KHZ	3.400	2	0.15
NAS0630T-152M-S	1500	50 @100KHZ	4.200	2	0.12
NAS0630T-222M-S	2200	50 @100KHZ	8.500	2	0.10
NAS0630T-332M-S	3300	50 @100KHZ	11.00	1	0.08
NAS0630T-472M-S	4700	50 @100KHZ	13.90	1	0.06
NAS0630T-682M-S	6800	50 @100KHZ	25.00	1	0.04
NAS0630T-103M-S	10000	50 @100KHZ	32.80	0.8	0.02

1. Inductance tested at 0.1Vrms, 100KHZ..

2. 30°C Temperature rise.

3. Operating Temperature Range -40°C to 85°C

4. Electrical specification at 25°C

5. Inductance : M : $\pm 20\%$

SHAPE AND DIMENSIONS

Dimensions : mm

LAND PATTERNS PCB

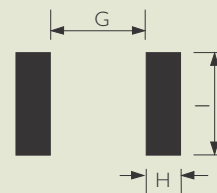
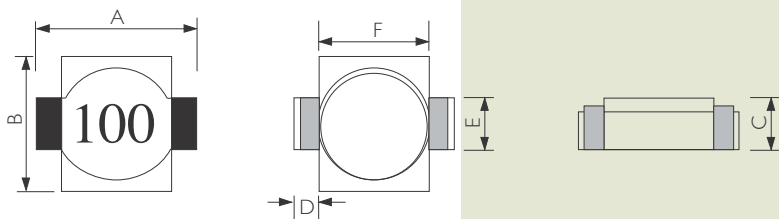

TYPE	A	B	C	D	E	F	G	H	I
NAS0630	6.50MAX	5.3 ± 0.3	3.0MAX	0.9	2.6	4.5	4.0	1.40	3.56

SMT Power Inductors

SCD Series



Features

- High saturation for surface mounting

Various high power surface mountable type inductors are superior to high saturation. These are also magnetic shielding type for consideration against radiation.

Application

- VRT, OA equipment, LCD television set, notebook computer, portable communications equipment, DC/DC converters, etc.

PRODUCT IDENTIFICATION

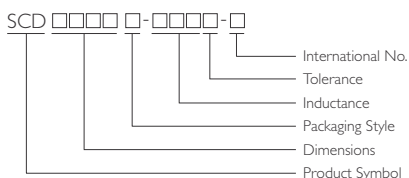

- Packing : T : Tape and Reel
- Tolerance : K±10%;M±20%
- Note : YAGEO will start to release SCD Series inductor with lead-free terminals that meet SONY SS-00259's criterial for lead-free product in Q2 of 2004, and YAGEO Internal No will changed to "N" as identification. Ex. SCD0403T-1R0N

SCDR1005B
(10μH ~ 470μH)

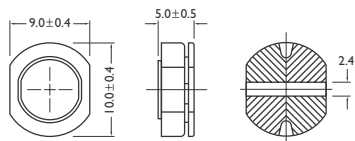

SHAPES AND DIMENSIONS

Dimensions : mm

TYPE	DIMENSION				
SCD0403 (1μH ~ 68μH)					
Dimensions in mm	2.2μH~1500μH	1.0μH~1000μH	1.0μH~1000μH	1.0μH~1000μH	1.0μH~1000μH
Dim.	SCD 03015	SCD 03021	SCD 0501	SCD 0502	SCD 03015
A	3.3±0.3	3.3±0.3	5.8±0.3	5.8±0.3	5.8±0.3
B	3.0±0.3	3.0±0.3	5.2±0.3	5.2±0.3	5.2±0.3
C	1.5±0.3	2.1±0.3	2.2Max.	2.5±0.3	3±0.3
D	1.0±TYP.	1.0±TYP.	2.0±TYP.	2.0±TYP.	2.0±TYP.
SCD0504 (10μH ~ 220μH)					
Dimensions in mm	2.2μH~1500μH	1.0μH~1000μH	1.0μH~1000μH	1.0μH~1000μH	1.0μH~1000μH
Dim.	SCD 03015	SCD 03021	SCD 0501	SCD 0502	SCD 03015
A	3.3±0.3	3.3±0.3	5.8±0.3	5.8±0.3	5.8±0.3
B	3.0±0.3	3.0±0.3	5.2±0.3	5.2±0.3	5.2±0.3
C	1.5±0.3	2.1±0.3	2.2Max.	2.5±0.3	3±0.3
D	1.0±TYP.	1.0±TYP.	2.0±TYP.	2.0±TYP.	2.0±TYP.
SCD0703 (10μH ~ 330μH)					
Dimensions in mm	2.2μH~1500μH	1.0μH~1000μH	1.0μH~1000μH	1.0μH~1000μH	1.0μH~1000μH
Dim.	SCD 03015	SCD 03021	SCD 0501	SCD 0502	SCD 03015
A	3.3±0.3	3.3±0.3	5.8±0.3	5.8±0.3	5.8±0.3
B	3.0±0.3	3.0±0.3	5.2±0.3	5.2±0.3	5.2±0.3
C	1.5±0.3	2.1±0.3	2.2Max.	2.5±0.3	3±0.3
D	1.0±TYP.	1.0±TYP.	2.0±TYP.	2.0±TYP.	2.0±TYP.
SCD0705 (10μH ~ 470μH)					
Dimensions in mm	2.2μH~1500μH	1.0μH~1000μH	1.0μH~1000μH	1.0μH~1000μH	1.0μH~1000μH
Dim.	SCD 03015	SCD 03021	SCD 0501	SCD 0502	SCD 03015
A	3.3±0.3	3.3±0.3	5.8±0.3	5.8±0.3	5.8±0.3
B	3.0±0.3	3.0±0.3	5.2±0.3	5.2±0.3	5.2±0.3
C	1.5±0.3	2.1±0.3	2.2Max.	2.5±0.3	3±0.3
D	1.0±TYP.	1.0±TYP.	2.0±TYP.	2.0±TYP.	2.0±TYP.
SCD1004 (10μH ~ 560μH)					
Dimensions in mm	2.2μH~1500μH	1.0μH~1000μH	1.0μH~1000μH	1.0μH~1000μH	1.0μH~1000μH
Dim.	SCD 03015	SCD 03021	SCD 0501	SCD 0502	SCD 03015
A	3.3±0.3	3.3±0.3	5.8±0.3	5.8±0.3	5.8±0.3
B	3.0±0.3	3.0±0.3	5.2±0.3	5.2±0.3	5.2±0.3
C	1.5±0.3	2.1±0.3	2.2Max.	2.5±0.3	3±0.3
D	1.0±TYP.	1.0±TYP.	2.0±TYP.	2.0±TYP.	2.0±TYP.
SCD1005 (10μH ~ 820μH)					
Dimensions in mm	2.2μH~1500μH	1.0μH~1000μH	1.0μH~1000μH	1.0μH~1000μH	1.0μH~1000μH
Dim.	SCD 03015	SCD 03021	SCD 0501	SCD 0502	SCD 03015
A	3.3±0.3	3.3±0.3	5.8±0.3	5.8±0.3	5.8±0.3
B	3.0±0.3	3.0±0.3	5.2±0.3	5.2±0.3	5.2±0.3
C	1.5±0.3	2.1±0.3	2.2Max.	2.5±0.3	3±0.3
D	1.0±TYP.	1.0±TYP.	2.0±TYP.	2.0±TYP.	2.0±TYP.



SCD STANDARD SPECIFICATIONS

Electrical Characteristics

Standard Specifications

Stamp	Inductance (μH)	Rated D.C. Current (A) Max.											
		SCD 03015	SCD 03021	SCD 0403	SCD 0501	SCD 0502	SCD 0503	SCD 0504	SCD 0703	SCD 0705	SCD 1004	SCD 1005	SCDR 1005B
1R0	1.0		2.080	3.80	4.00	4.50	4.50			3.70			
1R2	1.2					4.20							
1R4	1.4		1.860	3.30	3.60	4.00				3.70			
1R5	1.5					4.10							
1R8	1.8		1.800	2.91	3.00	3.30	3.70			3.70			
2R2	2.2	0.79	1.390	2.60	2.65	2.94	3.50						
2R7	2.7		1.320	2.43	2.20	2.50	3.20			3.70			
3R3	3.3		1.250	2.15	2.11	2.35	2.80						
3R9	3.9		1.200	1.98	2.00	2.20	2.60			3.70			
4R7	4.7	0.65	1.130	1.70	1.80	2.00	2.50			3.50		2.60	
5R6	5.6		0.910	1.60	1.60	1.80	2.40			3.30			
6R8	6.8		0.850	1.41	1.50	1.70	2.20			3.10		4.33	
8R2	8.2		0.820	1.26	1.30	1.40	2.00			2.70			
100	10	0.45	0.740	1.15	1.10	1.20	1.80	1.44	1.44	2.30	2.38	2.60	2.06
120	12		0.640	1.05	1.05	1.18	1.75	1.40	1.39	2.00	2.13	2.45	1.94
150	15	0.30	0.600	0.92	1.00	1.15	1.70	1.30	1.24	1.80	1.87	2.27	1.72
180	18		0.540	0.84	0.95	1.10	1.60	1.23	1.12	1.60	1.73	2.15	1.58
220	22	0.25	0.500	0.76	0.90	1.00	1.50	1.11	1.07	1.50	1.60	1.95	1.42
270	27		0.430	0.71	0.77	0.86	1.40	0.97	0.94	1.30	1.44	1.76	1.32
330	33	0.20	0.400	0.64	0.68	0.76	1.10	0.88	0.85	1.20	1.26	1.50	1.16
390	39		0.370	0.59	0.67	0.75	1.00	0.80	0.74	1.10	1.20	1.37	1.10
470	47	0.17	0.360	0.54	0.66	0.73	0.90	0.72	0.68	1.10	1.10	1.28	1.00
500	50		0.330		0.61								
560	56		0.310	0.50	0.50	0.55	0.85	0.68	0.64	0.94	1.01	1.17	0.93
680	68	0.13	0.300	0.467	0.47	0.52	0.80	0.61	0.59	0.85	0.91	1.11	0.85
750	75		0.290		0.46								
820	82		0.280		0.45	0.50	0.65	0.58	0.54	0.78	0.85	1.00	0.79
101	100	0.10	0.250	0.40	0.36	0.40	0.60	0.52	0.51	0.72	0.74	0.97	0.72
121	120		0.200		0.32	0.36	0.58	0.48	0.49	0.66	0.69	0.89	0.63
151	150		0.190		0.270	0.30	0.43	0.40	0.40	0.58	0.61	0.78	0.55
181	180		0.170		0.230	0.26	0.41	0.38	0.36	0.51	0.56	0.72	0.50
221	220		0.160		0.220	0.25	0.38	0.35	0.31	0.49	0.53	0.66	0.47
271	270		0.140		0.190	0.21	0.35	0.29	0.29	0.42	0.45	0.57	0.41
301	300		0.135		0.180								
331	330		0.130		0.160	0.18	0.28	0.28	0.28	0.40	0.42	0.52	0.37
391	390		0.120		0.150	0.16	0.26	0.26		0.36	0.38	0.48	0.35
471	470		0.084		0.135	0.15	0.20	0.12		0.34	0.35	0.42	0.33
561	560		0.080		0.130	0.14	0.19	0.10			0.32	0.33	
681	680		0.080		0.120	0.13	0.18	0.08				0.28	
821	820		0.070		0.063	0.07	0.15	0.05				0.24	
102	1000		0.060		0.045	0.05	0.13	0.03					
122	1200	0.05											
152	1500	0.03											

Tolerance Of Inductors

- SCD03015 1.0 ~ 100 μH $\pm 20\%$ (M)
- SCD03021 1.0 ~ 1000 μH $\pm 20\%$ (M)
- SCD0403 1.0 ~ 27 μH $\pm 20\%$ (M) 33 ~ 68 μH $\pm 10\%$ (K)
- SCD0501 1.0 ~ 27 μH $\pm 20\%$ (M) 33 ~ 1000 μH $\pm 10\%$ (K)
- SCD0502 1.0 ~ 27 μH $\pm 20\%$ (M) 33 ~ 1000 μH $\pm 10\%$ (K)
- SCD0504 1.0 ~ 27 μH $\pm 20\%$ (M) 33 ~ 47 μH $\pm 15\%$ (K) 56 ~ 220 μH $\pm 10\%$ (K)
- SCD0703 10 ~ 47 μH $\pm 20\%$ (M) 56 ~ 330 μH $\pm 10\%$ (K)
- SCD0705 10 ~ 470 μH $\pm 10\%$ (K)
- SCD1004 10 ~ 47 μH $\pm 20\%$ (M) 56 ~ 560 μH $\pm 10\%$ (K)
- SCD1005 10 ~ 39 μH $\pm 20\%$ (M) 47 ~ 820 μH $\pm 10\%$ (K)
- SCDR1005B 10 ~ 27 μH $\pm 20\%$ (M) 33 ~ 82 μH $\pm 15\%$

※ This indicates the value of current when the inductance is 10% lower than its initial value at D.C superposition or D.C current when at $\Delta t = 40^\circ$ whichever is lower



SCD STANDARD SPECIFICATIONS

Electrical Characteristics

Standard Specifications

Stamp	Inductance (μ H)	D.C.R (Ω) Max.											
		SCD 03015	SCD 03021	SCD 0403	SCD 0501	SCD 0502	SCD 0503	SCD 0504	SCD 0703	SCD 0705	SCD 1004	SCD 1005	SCDR 1005B
1R0	1.0		0.07	0.033	0.034	0.03	0.03			0.02			
1R2	1.2						0.03						
1R4	1.4		0.09	0.038	0.048	0.04				0.02			
1R5	1.5						0.03						
1R8	1.8		0.11	0.042	0.062	0.05	0.03			0.02			
2R2	2.2	0.10 \pm 30%	0.13	0.047	0.064	0.06	0.03						
2R7	2.7		0.14	0.052	0.078	0.07	0.04			0.02			
3R3	3.3		0.17	0.058	0.097	0.08	0.05						
3R9	3.9		0.19	0.076	0.105	0.09	0.06			0.03			
4R7	4.7	0.15 \pm 30%	0.21	0.094	0.134	0.14	0.07			0.04		0.040	
5R6	5.6		0.22	0.101	0.170	0.15	0.08			0.04			
6R8	6.8		0.25	0.117	0.187	0.16	0.09			0.04		0.037	
8R2	8.2		0.28	0.132	0.225	0.17	0.10			0.05			
100	10	0.30 \pm 30%	0.32	0.182	0.255	0.18	0.12	0.10	0.08	0.07	0.05	0.060	0.06
120	12		0.35	0.210	0.292	0.20	0.13	0.12	0.09	0.08	0.06	0.070	0.07
150	15	0.58 \pm 30%	0.40	0.235	0.360	0.22	0.15	0.14	0.10	0.09	0.07	0.080	0.07
180	18		0.48	0.338	0.430	0.25	0.18	0.15	0.11	0.10	0.08	0.090	0.08
220	22	0.71 \pm 30%	0.58	0.378	0.492	0.35	0.22	0.18	0.13	0.11	0.09	0.100	0.08
270	27		0.65	0.522	0.603	0.45	0.26	0.20	0.15	0.12	0.10	0.110	0.10
330	33	1.10 \pm 30%	0.80	0.540	0.796	0.56	0.33	0.23	0.17	0.13	0.12	0.120	0.11
390	39		0.90	0.587	0.897	0.69	0.42	0.32	0.22	0.16	0.15	0.140	0.12
470	47	1.30 \pm 30%	1.19	0.844	1.020	0.72	0.50	0.37	0.25	0.18	0.17	0.170	0.14
500	50		1.22		1.040								
560	56		1.27	0.937	1.164	0.84	0.55	0.42	0.28	0.24	0.20	0.190	0.19
680	68	2.20 \pm 30%	1.73	1.117	1.220	0.90	0.65	0.46	0.33	0.28	0.22	0.220	0.21
750	75		1.90		1.340								
820	82		1.99		1.570	1.20	0.80	0.60	0.41	0.37	0.25	0.25	0.28
101	100	3.50 \pm 30%	2.52	2.000	1.800	1.30	0.90	0.70	0.48	0.43	0.34	0.35	0.34
121	120		2.90		2.000	1.38	1.00	0.93	0.54	0.47	0.40	0.40	0.37
151	150		3.36		2.80	1.81	1.30	1.10	0.75	0.64	0.54	0.47	0.51
181	180		5.10		3.15	1.95	1.50	1.38	1.02	0.71	0.62	0.63	0.57
221	220		5.80		4.40	3.00	2.00	1.57	1.20	0.96	0.72	0.73	0.78
271	270		7.80		6.40	3.20	2.50	1.85	1.31	1.11	0.95	0.97	0.87
301	300		8.10		6.75								
331	330		9.24		7.20	3.82	3.20	2.00	1.50	1.26	1.10	1.15	1.20
391	390		10.14		8.40	4.68	3.50	2.60		1.77	1.24	1.30	1.34
461	460		11.15		12.0								
471	470		11.48		12.4	5.10	4.20	3.00		1.96	1.53	1.48	1.50
61	560		19.49		13.0	8.50	4.50	4.19			1.90	1.90	
681	680		22.00		17.0	10.0	6.50	4.44				2.25	
821	820		23.98		19.5	12.0	7.50	5.12				2.55	
102	1000		28.80		24.0	18.0	8.00	10.00					
122	1200	38 \pm 30%											
152	1500	55 \pm 30%											

■ Test Freq.(L): SCD03015: (1MHz/1V)

SCD03021/0403/0501/0502/0503 : 1.0 ~ 8.2H(7.96MHz/1V), 10 ~ 82H (2.52MHz/1V), 100 ~1000H (1kHz/1V) .

SCD0504/0703/0705/1004 :1.0 ~ 8.2H(7.96M Hz/1V), 10 ~ 82H (2.52MHz/1V), 100 ~ 1000H (1kHz/1V) .

SCD1005 :1.0 ~ 8.2H(7.96M Hz/1V), 10 ~ 82H (2.52MHz/1V), 100 ~ 1000H (1kHz/1V) .

SCDR105B :1.0 ~ 8.2H(2.52M Hz/0.25V), 10 ~ 82H (1KHz/0.25V)

■ Test Instrument: L: HP 4192A

DCR : CHEN HWA 502BC

Rated D.C. Current : HP4284+42 841A or CH1061 +CH301A



GENERAL CHARACTERISTICS

Operating Temperature	-30 ~ +100°C (Contain Heading Coil)			
Appearance Inspection	No External Defects by Visual Inspection			
Terminal Strength	After soldering , between copper plate and terminals of coil , push in tow directions of X,Y with standing as blow conditions. Terminal should not peel off. (Refer to figure at right)			
	10.0N	10 Sec.	SCD0403	SCD0504
	15.0N	10 Sec.	SCD0703	SCD0705
	20.0N	10 Sec.	SCD1004	SCD1005
Heat Endurance of Reflow Soldering	Refer to Below Figure			
Insulating Resistance	Over 100MΩ at 100V D.C. between wire and core.			
Dielectric Strength	No dielectric breakdown at 100V D.C. for 1 minute between wire and core.			
Temperature Characteristics	Inductance coefficient (0 ~ 2,000) × 10 ⁻⁶ /°C (-25 ~ +80°C)			
Humidity Characteristics	Inductance deviation within ±5.0% , after 96 hours in 90 ~ 95% relative humidity at 40 ± 2°C and 1 hour drying under normal condition.			
Vibration Resistance	Inductance deviation within ±5.0% , after vibration for 1 hour. In each of three orientations at sweep vibration (10 ~ 55 ~ 10Hz) with 1.5 mm p-p amplitude.			

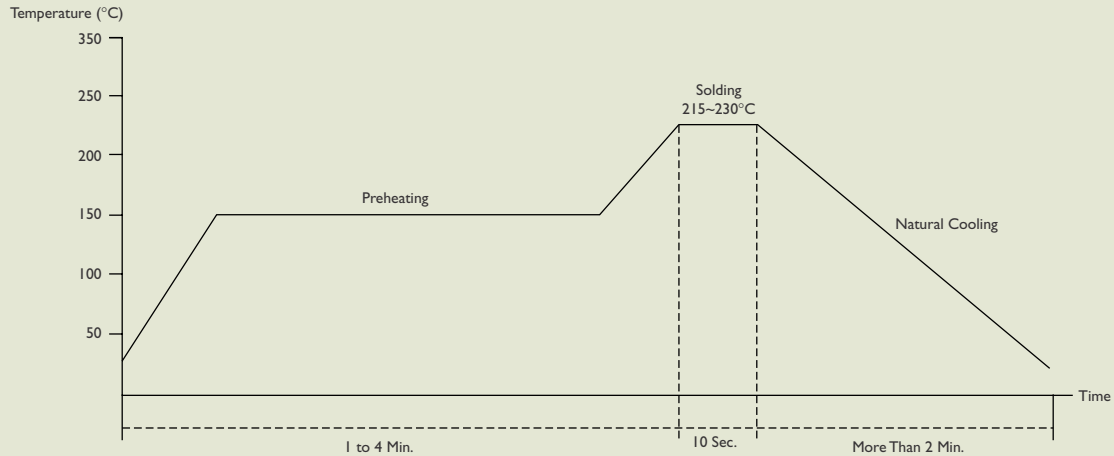
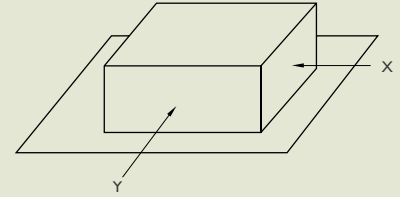



SMD Unshielded Power Inductors - SCD Series

Packaging Specifications

Tape Material

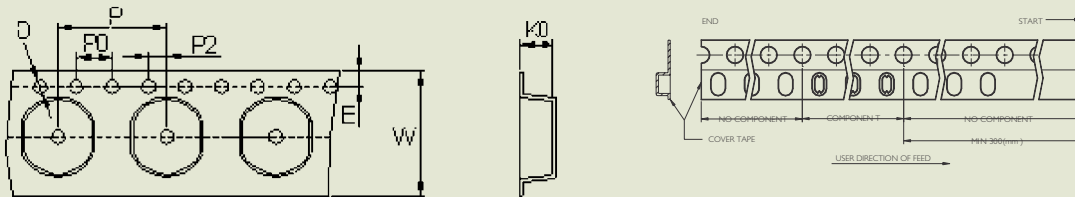

Reel Dimensions

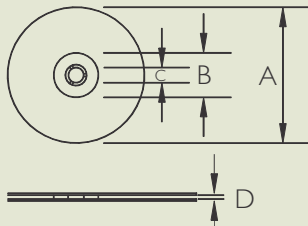

Dimensions in mm

Dimensions : mm

TYPE	TAPE DIMENSIONS							RECOMMENDED PATTERN		REEL DIMENSIONS				QUANTITY PCS/REEL
	K0	D	E	W	P	P0	P2	A	B	A	B	C	D	
SCD0301	1.2	1.50	1.75	12	8	4	2			330	100	13	13.4	5000
SCD03015	1.80	1.55	1.75	12	8	4	2	4.5	1.0	330	100	13	13.4	3000
SCD03021	2.50	1.55	1.75	12	8	4	2	4.5	1.0	330	100	13	13.4	3000
SCD0403	3.1	1.55	1.75	12	8	4	2	5.5	1.2	330	100	13	13.4	2000
SCD0501	2.35	1.55	1.75	12	8	4	2	6.8	2.0	330	100	13	13.4	2000
SCD0502	3.00	1.55	1.75	12	8	4	2	6.8	2.0	330	100	13	13.4	2000
SCD0503	3.30	1.55	1.75	12	8	4	2	6.8	2.0	330	100	13	13.4	2000
SCD0504	4.8	1.55	1.75	16	8	4	2	6.8	1.3	330	100	13	17.4	1500
SCD0703	3.8	1.55	1.75	16	12	4	2	8.8	2.1	330	100	13	17.4	1000
SCD0705	5.2	1.55	1.75	16	12	4	2	8.8	2.1	330	100	13	17.4	700
SCD1004	5.8	1.55	1.75	24	12	4	2	11	2.1	330	100	13	24.4	700
SCD1005	5.8	1.55	1.75	24	12	4	2	11	2.1	330	100	13	24.4	700
SCDR105B	5.8	1.55	1.75	24	12	4	2	10	2.5	330	100	13	24.4	500



TYPICAL ELECTRICAL CHARACTERISTICS

Curves of SCD Series

Test Instruments : HP4291A Impedance / Material Analyzer

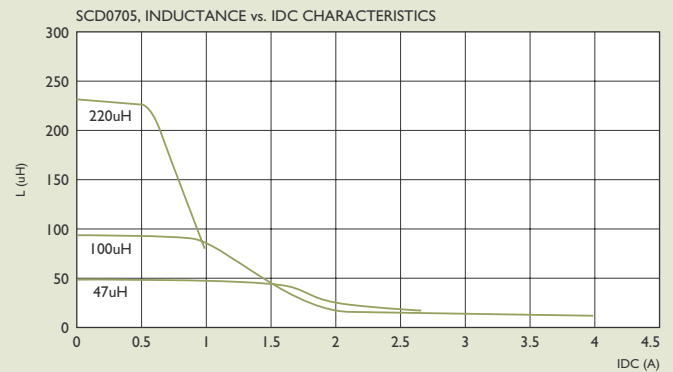
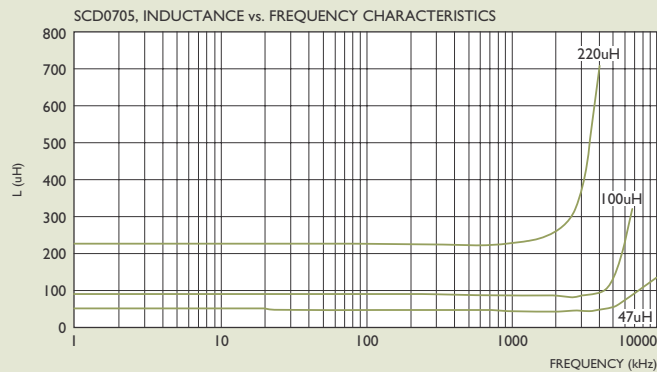
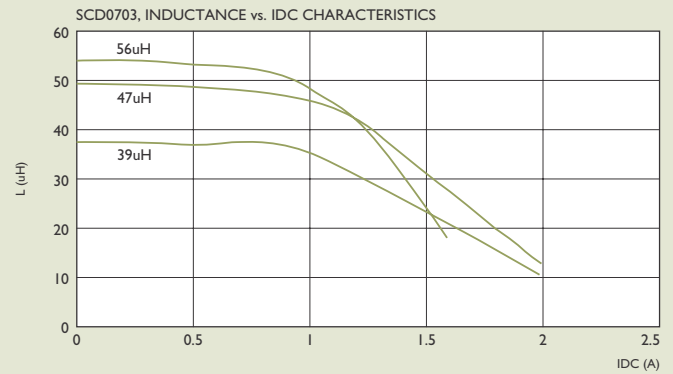
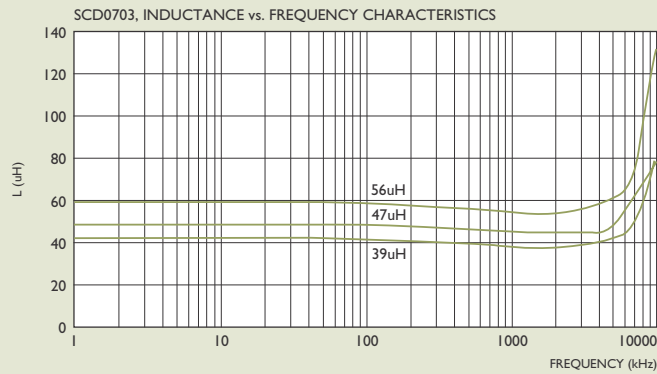
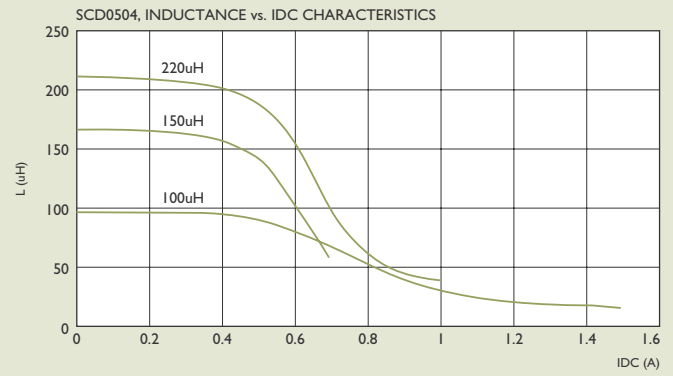
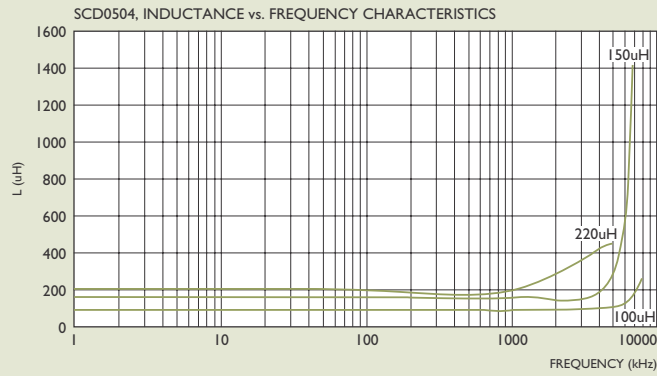
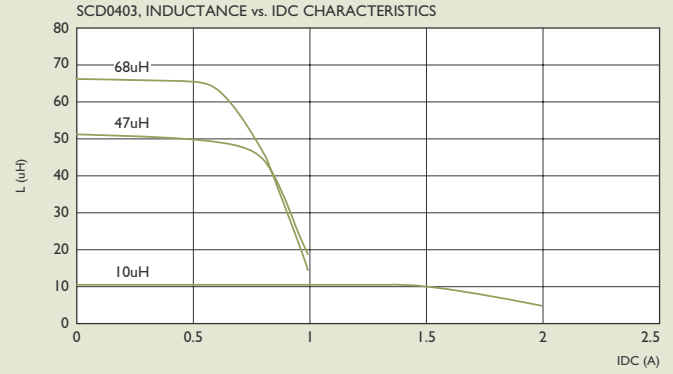
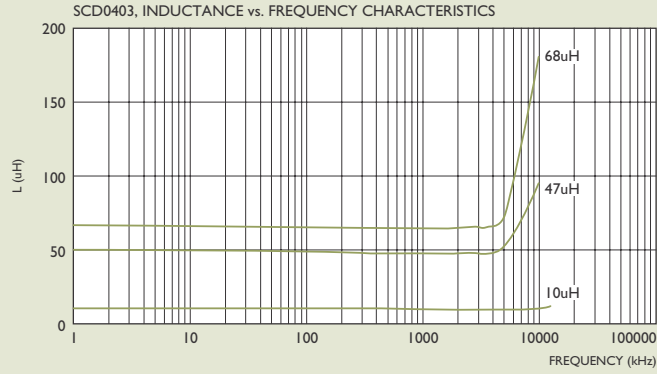



TYPICAL ELECTRICAL CHARACTERISTICS

Curves of SCD Series

Test Instruments : HP4291A Impedance / Material Analyzer

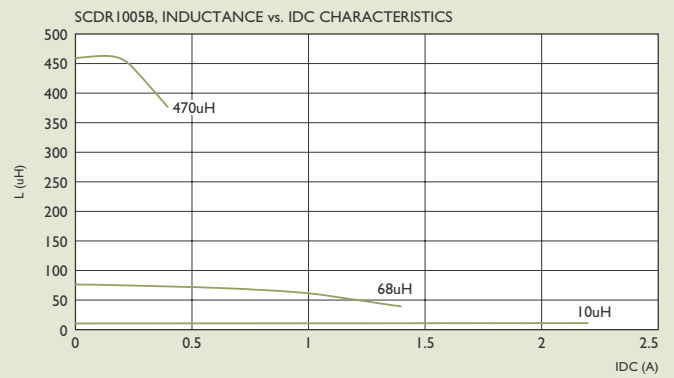
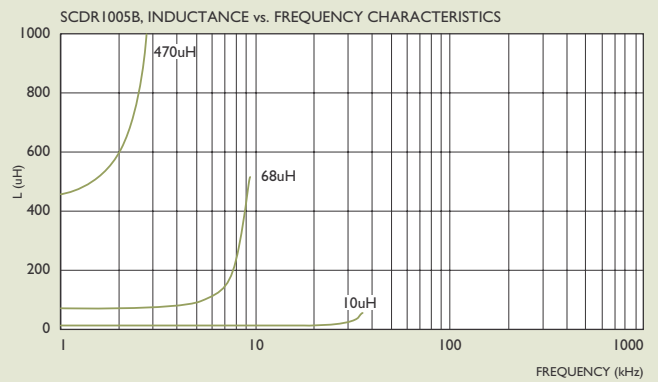
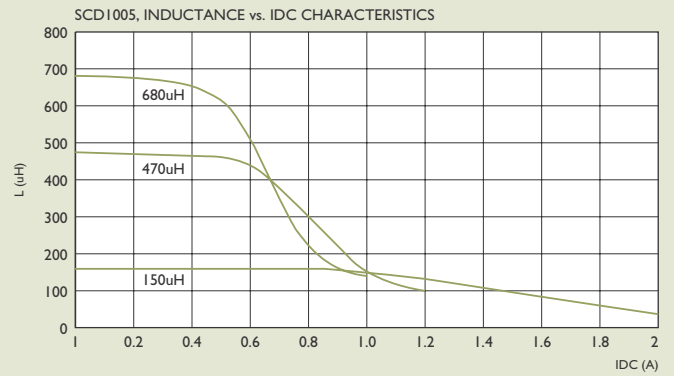
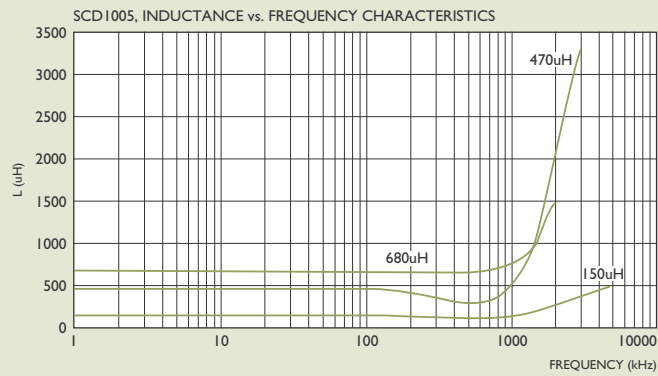
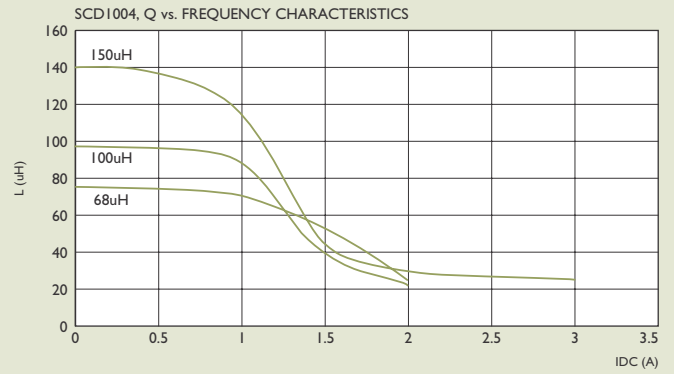
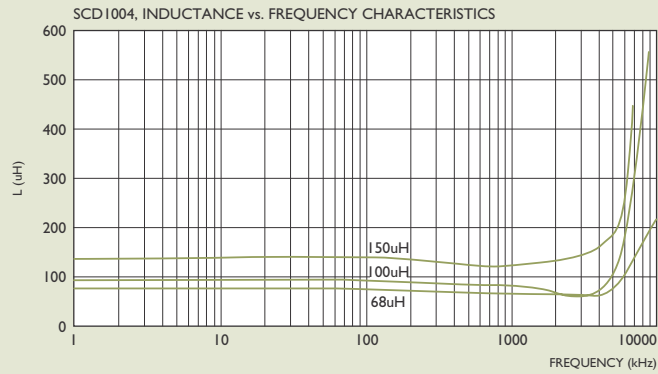



SCD SERIES RELIABILITY TEST

I-1 MECHANICAL PERFORMANCE

NO.	ITEM	SPECIFICATION	TEST CONDITIONS
I-1-1	Vibration	Appearance : No Damage L Change : within $\pm 10\%$ Q Change : within $\pm 30\%$ RDC : within Specification	Test device shall be soldered on the substrate. Oscillation Frequency : 10 to 55 to 10Hz for 1Min. Amplitude : 1.5mm Time : 2Hrs. for each Axis (X,Y & Z), Total 6Hrs.
I-1-2	Resistance to Soldering Heat	Appearance : No Damage	Pre-heating : 150°C, 1Min. Solder Composition : Sn/Pb = 63/37 Solder Temperature : 260 \pm 5°C Immersion Time : 10 \pm 1Sec.
I-1-3	Solderability	The electrodes shall be at least 90% covered with new solder coating.	Pre-heating : 150°C, 1Min. Solder Composition : Sn/Pb = 63/37 Solder Temperature : 230 \pm 5°C Immersion Time : 4 \pm 1Sec.

I-2 ENVIRONMENTAL PERFORMANCE

NO.	ITEM	SPECIFICATION	TEST CONDITIONS															
I-2-1	Temperature Shock	Appearance : No Damage L Change : within $\pm 10\%$ L Change : within $\pm 30\%$ RDC : within Specification	10 Cycles (Air to Air) Cycles shall Consist of : 30Min. Exposure to -55°C 30Min. Exposure to -125°C 15Sec. Max. Transition between Temperatures Measured after Exposure in the Room Condition for 24Hrs.															
I-2-2	Temperature Cycle		One Cycle <table border="1"><thead><tr><th>Step</th><th>Temperature (°C)</th><th>Time (Min.)</th></tr></thead><tbody><tr><td>1</td><td>-25 \pm 3</td><td>30</td></tr><tr><td>2</td><td>25 \pm 2</td><td>3</td></tr><tr><td>3</td><td>85 \pm 3</td><td>30</td></tr><tr><td>4</td><td>25 \pm 2</td><td>3</td></tr></tbody></table> Total : 100 Cycles Measured after Exposure in the Room Condition for 24Hrs.	Step	Temperature (°C)	Time (Min.)	1	-25 \pm 3	30	2	25 \pm 2	3	3	85 \pm 3	30	4	25 \pm 2	3
Step	Temperature (°C)	Time (Min.)																
1	-25 \pm 3	30																
2	25 \pm 2	3																
3	85 \pm 3	30																
4	25 \pm 2	3																
I-2-3	Humidity Resistance		Temperature : 40 \pm 2°C Relative Humidity : 90 ~ 95% Time : 1000Hrs. Measured after Exposure in the Room Condition for 24Hrs.															
I-2-4	High Temperature Resistance		Temperature : 85 \pm 3°C Relative Humidity : 20% Applied Current : Rated Current Time : 1000Hrs. Measured after Exposure in the Room Condition for 24Hrs.															
I-2-5	Low Temperature Resistance		Temperature : -25 \pm 3°C Relative Humidity : 0% Time : 1000Hrs. Measured after Exposure in the Room Condition for 24Hrs.															

SCDS Series

SMT Power Inductors

CONFIGURATION AND DIMENSIONS

Dimensions : mm

TYPE	SHAPES AND DIMENSION		
SCDS62T (3.3μH ~ 330μH)			
SCDS64T (10μH ~ 1000μH)			
SCDS73 (10μH ~ 1.0mH)			
SCDS74 (10μH ~ 1.0mH)			
SCDS104R (1.5μH ~ 330μH)			
SCDS125 (10μH ~ 1.0mH)			
SCDS127 (10μH ~ 47mH)			



OUTLINE

SMT power inductors are formed by directly connected ferrite electrode with magnetic shielding.

- T : Packing : Tape and Reel
- HP : Low DCR
- LD : High Power
- Tolerance : K=±10% ; M=±20% ; T=±30%
- CEC Internal No. B: Silver plated terminals (3D12~6D38); S: Base type terminals (2D11~2D18HP & 62T&127)
- Note : YAGEO will start to release SCD Series inductor with lead-free terminals that meet SONY SS-00259's criterion for lead-free product in Q2 of 2004, and YAGEO Internal No will be changed to "N" as identification.

PRODUCT IDENTIFICATION

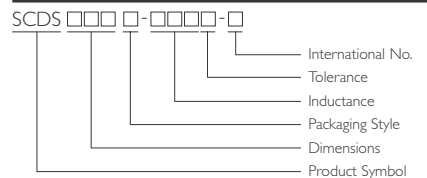

Features

- Available in magnetically shielded.
- Low DC resistance.
- Suitable for large currents.
- Ideal for a variety of DC - DC converter inductor applications.
- Available on tape and reel for auto surface mounting.

Applications

- Power supply for VTRs.
- OA equipment.
- LCD televisions.
- Notebook PCs.
- Portable communication equipment.
- DC / DC converters, etc.

SCDS124

(3.9μH ~ 330mH)

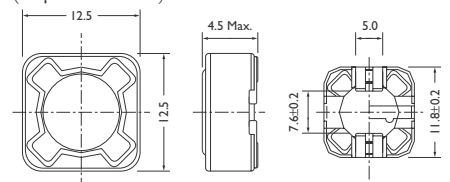



STANDARD SPECIFICATIONS

Stamp	Inductance (μH)	D.C.R.(m Ω)Max.								Rated Current(A)Max.							
		SCDS 62T	SCDS 64T	SCDS 73	SCDS 74	SCDS 104R	SCDS 124	SCDS 125	SCDS 127	SCDS 62	SCDS 64	SCDS 73	SCDS 74	SCDS 104R	SCDS 124	SCDS 125	SCDS 127
1R0	1.0																
1R2	1.2								7.0								9.80
1R5	1.5					8.1								10.0			
1R8	1.8																
2R2	2.2																
2R4	2.4								11.5								8.00
2R5	2.5					10								7.5			
2R7	2.7																
3R0	3.0																
3R3	3.3	68								1.94							
3R5	3.5								13.5								7.50
3R8	3.8					13								6.0			
3R9	3.9						15								6.50		
4R1	4.1																
4R2	4.2																
4R7	4.7	80						18		15.8	1.63				5.70		6.80
5R0	5.0																
5R2	5.2					22								5.5			
5R3	5.3																
5R4	5.4																
5R5	5.5	96									1.40						
5R6	5.6																
6R0	6.0																
6R1	6.1								17.6								6.60
6R2	6.2																
6R8	6.8	100					23				1.33				4.90		
7R0	7.0					27											
7R3	7.3																
7R4	7.4																
7R6	7.6								20.0								5.90
8R2	8.2	100								1.14							
8R6	8.6																
8R7	8.7																
8R9	8.9																
100	10	150	120	72	49	35	28	25	21.6	1.10	1.35	1.68	1.84	4.4	4.50	4.00	5.40
120	12	200	130	98	58		38	27	24.3	1.00	1.22	1.52	1.71		4.00	3.50	4.90
150	15	230	180	130	81	50	50	30	27.0	0.90	1.11	1.33	1.47	3.6	3.20	3.30	4.50
180	18	270	240	140	91		57	34	39.2	0.80	1.02	1.20	1.31		3.10	3.00	3.90
220	22	340	270	190	110	73	66	36	43.2	0.74	0.91	1.07	1.23	2.9	2.90	2.80	3.60
270	27	380	300	210	150		80	51	45.9	0.66	0.82	0.96	1.12		2.80	2.30	3.40
330	33	450	330	240	170	93	97	57	64.8	0.59	0.74	0.91	0.96	2.3	2.70	2.10	3.00
390	39	490	370	320	230		132	68	72.9	0.54	0.69	0.77	0.91		2.10	2.00	2.75
470	47	690	520	360	260	128	150	75	100	0.50	0.62	0.76	0.88	2.1	1.90	1.80	2.50
560	56	780	560	470	350		190	110	110	0.46	0.58	0.68	0.75		1.80	1.70	2.35
680	68	1070	630	520	380	213	220	120	140	0.42	0.51	0.61	0.69	1.5	1.50	1.50	2.10
820	82	1210	710	690	430		260	140	160	0.38	0.46	0.57	0.61		1.30	1.40	1.95
101	100	1390	1030	790	610	304	308	160	220	0.34	0.42	0.50	0.60	1.35	1.20	1.30	1.70
121	120	1900	1150	890	660		380	170	250	0.31	0.38	0.49	0.52		1.10	1.10	1.60
151	150	2180	1680	1270	880	506	530	230	280	0.28	0.35	0.43	0.46	1.15	0.95	1.00	1.42
181	180	2770	1870	1450	980		620	290	350	0.26	0.32	0.39	0.42		0.85	0.90	1.30
221	220	3120	2080	1650	1170	756	700	400	390	0.23	0.29	0.35	0.36	0.92	0.80	0.80	1.16
271	270	4380	2370	2310	1640		876	460	560	0.22	0.26	0.32	0.34		0.60	0.75	1.06
331	330	4940	2670	2620	1860	1.09	990	510	640	0.19	0.23	0.28	0.32	0.70	0.50	0.68	0.95
391	390		2940	2940	2850			690	700		0.22	0.26	0.29			0.65	0.88
471	470		3930	4180	3010			770	980		0.20	0.24	0.26			0.58	0.79

• Test Freq.(L): SCDS62: 3.3 ~ 8.2 μH (7.96MHz/1V), 10~82 μH (2.52MHz/1V), 100 ~ 330 μH (1KHz/1V)
SCDS64/73/74/125/127: (1KHz/1V)

• Other type Rated current : The rate current indicastes the current when the inductance decreases to 65%. Over of it's nominal value or D.C.current when the temperature rising $\Delta t = 40^{\circ}\text{C}$ lower, whichever is lower.

• Test Instrument :L : HP4192A LF IMPEDANCE ANALYZER
RDC : CHEN HWA 502BC
Rated current: HP4284+42841A or Ch1061+CH301A

Tolerance Of Inductors

- SCDS62 3.3~330 $\mu\text{H} \pm 20\%$ (M)
- SCDS64 10~1000 $\mu\text{H} \pm 20\%$ (M)
- SCDS73 10~1000 $\mu\text{H} \pm 20\%$ (M)
- SCDS74 10~1000 $\mu\text{H} \pm 20\%$ (M)
- SCDS104R 1.5~330 $\mu\text{H} \pm 30\%$ (T)
- SCDS124 3.9~330 $\mu\text{H} \pm 20\%$ (M)
- SCDS125 1.0~1000 $\mu\text{H} \pm 20\%$ (M)
- SCDS127 1.2~7.6 $\mu\text{H}^{+40,-20}\%$ (N)



TAPE DIMENSIONS

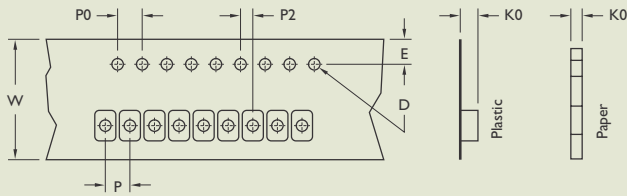

TAPE MATERIAL

Carrier Tape : Polystyrene

Cover Type : Polyethylene

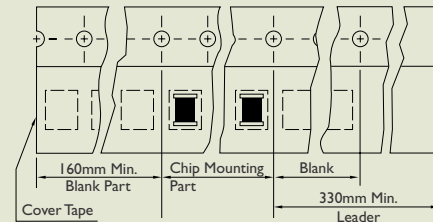

REEL DIMENSIONS

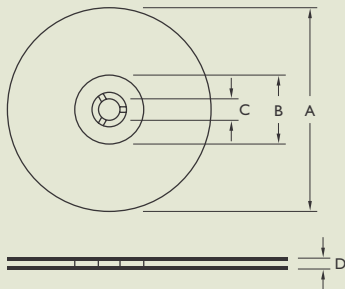

RECOMMENDED PATTERN

Land Pattern

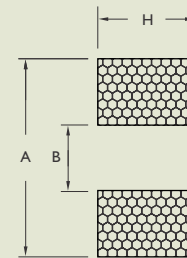

Dimensions : mm

TYPE	TAPE DIMENSIONS							RECOMMENDED PATTERN			REEL DIMENSIONS				QUANTITY
	K0	D	E	W	P	P0	P2	A	B	C	A	B	C	D	PCS/REEL
SCDS62T	3.4	1.55	1.75	16	12	4	2	8.1	4	2.5	330	100	13	17.4	1500
SCDS64T	4.9	1.55	1.75	16	12	4	2	8.1	4	2.5	330	100	13	17.4	1000
SCDS73T	3.6	1.55	1.75	16	12	4	2	8.4	4.4	2.2	330	100	13	17.4	1600
SCDS74T	5.0	1.55	1.75	16	12	4	2	8.4	4.4	2.2	330	100	13	17.4	1000
SCDS124T	5.1	1.55	1.75	24	16	4	2	13	7	5.4	330	100	13	24.4	500
SCDS125T	6.7	1.55	1.75	24	16	4	2	13	7	5.4	330	100	13	24.4	600
SCDS127T	8.7	1.55	1.75	24	16	4	2	13	7	5.4	330	100	13	24.4	500



TYPICAL ELECTRICAL CHARACTERISTICS

Curves of SCD Series

Test Instruments : HP4291A Impedance / Material Analyzer

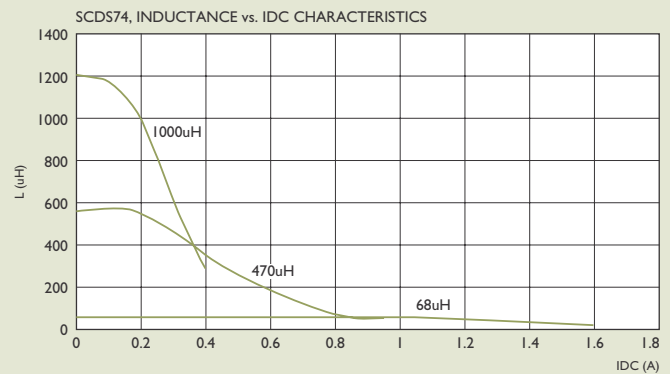
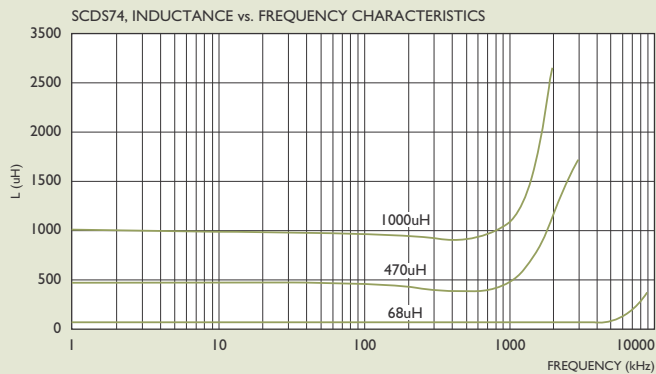
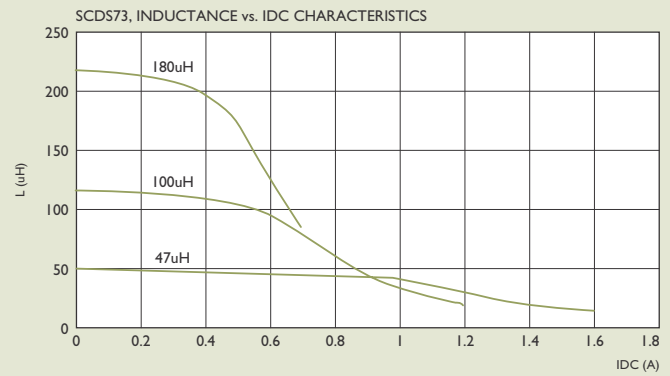
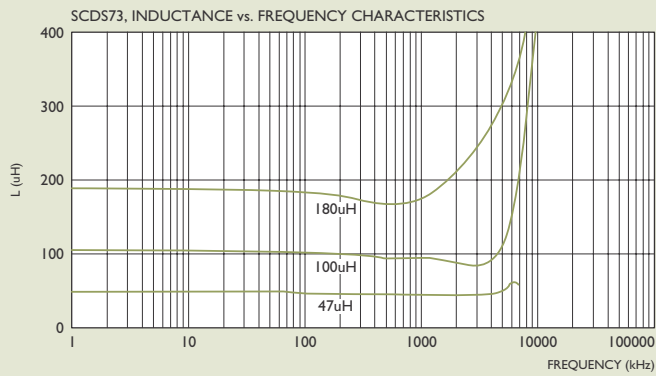
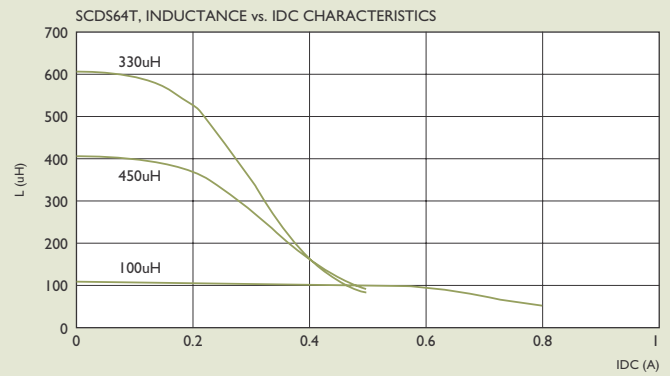
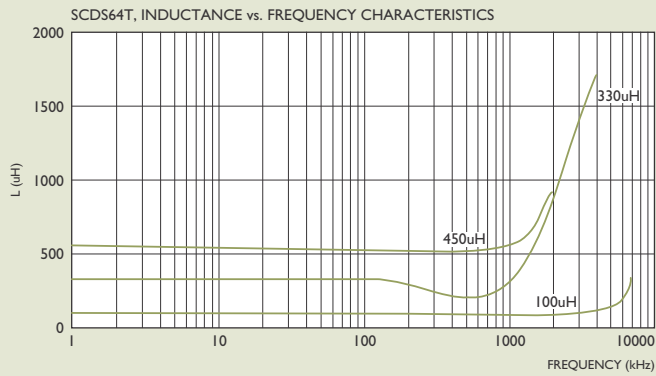
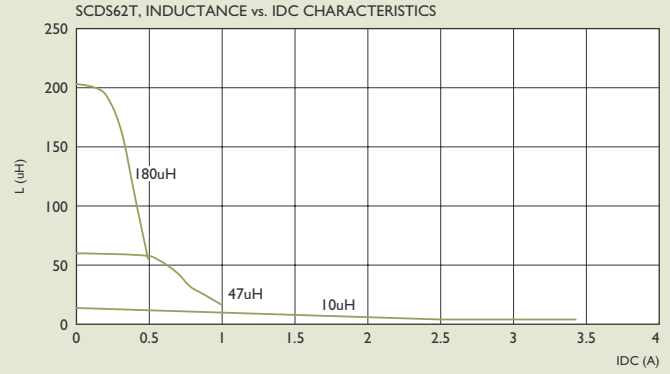
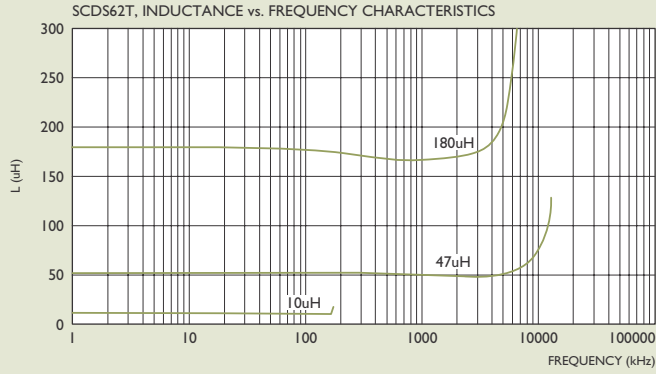



TYPICAL ELECTRICAL CHARACTERISTICS

TCurves of SCD Series

Test Instruments : HP4291A Impedance / Material Analyzer

SCDS104R-220MS, INDUCTANCE vs. FREQUENCY CHARACTERISTICS

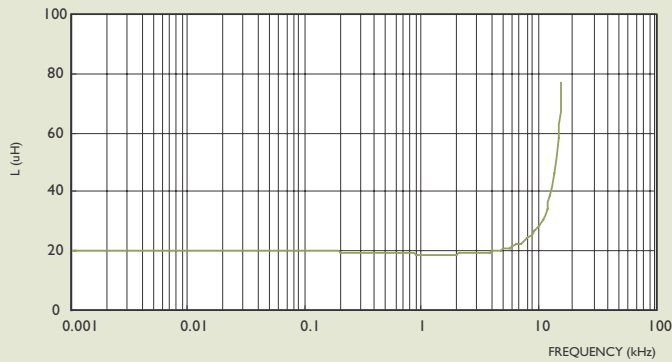

SCDS104R-220M-S

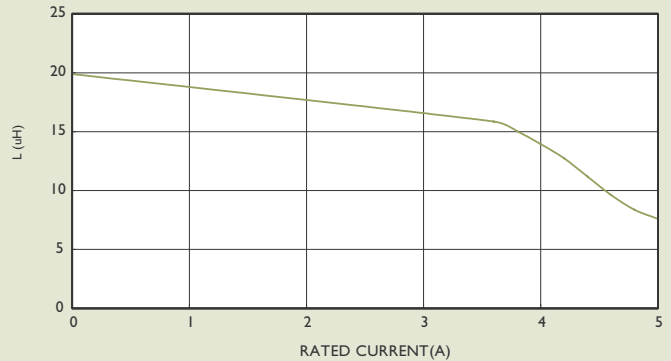

SCDS124, INDUCTANCE vs. FREQUENCY CHARACTERISTICS

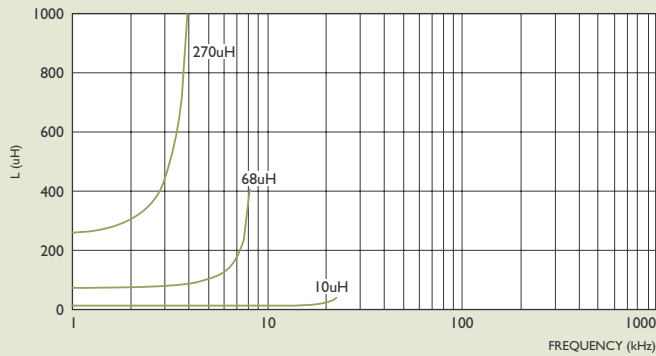

SCDS124, INDUCTANCE vs. IDC CHARACTERISTICS

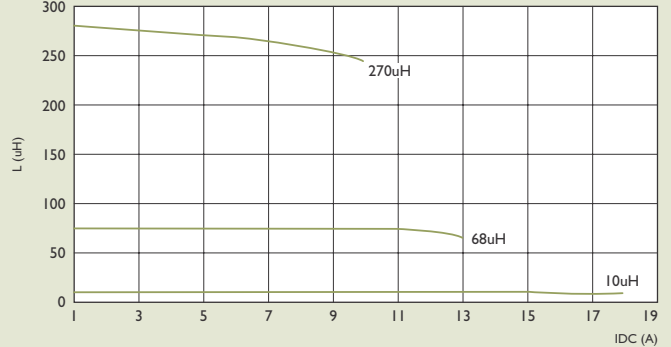

SCDS125, INDUCTANCE vs. FREQUENCY CHARACTERISTICS

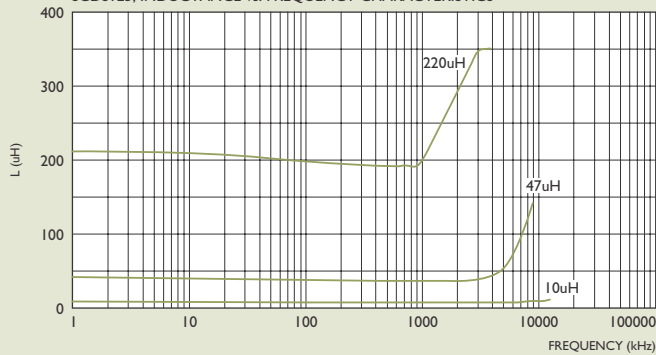

SCDS125, INDUCTANCE vs. IDC CHARACTERISTICS

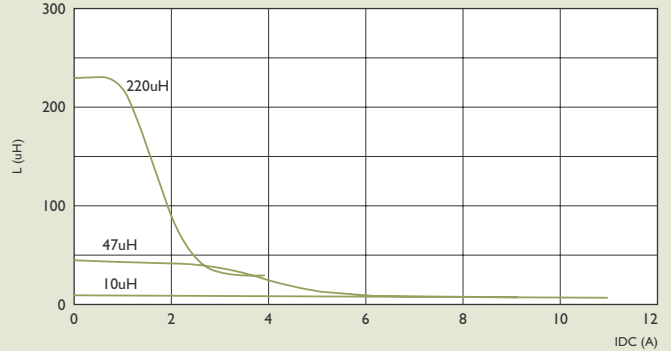

SCDS127, INDUCTANCE vs. FREQUENCY CHARACTERISTICS

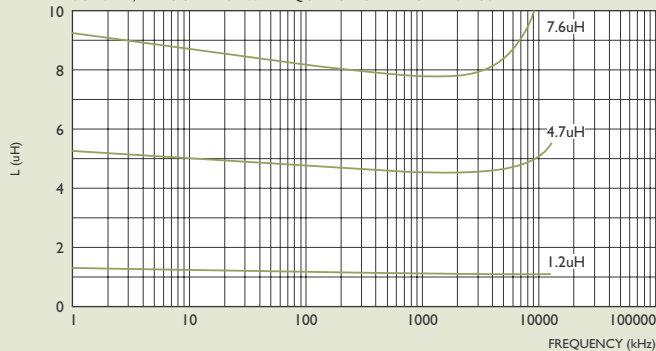

SCDS127, INDUCTANCE vs. IDC CHARACTERISTICS

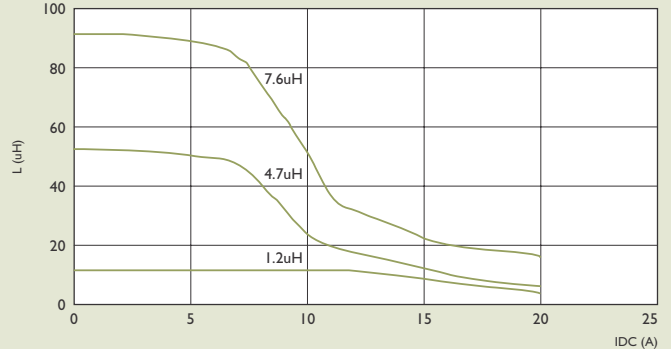



TYPICAL ELECTRICAL CHARACTERISTICS

Test Instruments : HP4291A Impedance / Material Analyzer

Packaging Specifications

SCDS 2D11 ~ 6D38

Tape Dimensions

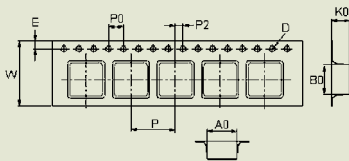

Tape Material

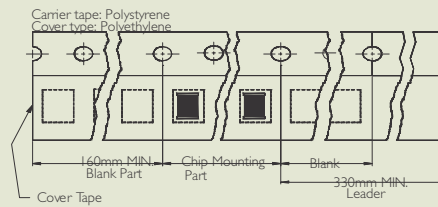

Reel Dimensions

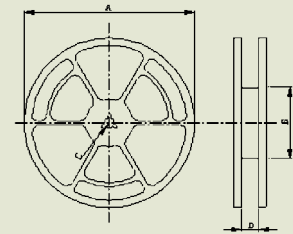

Dimensions in mm

TYPE	Tape Dimensions									Reel Dimensions				Quantity PCS / REEL	Recommended Pattern	
	A0	B0	K0	D	E	W	P	P0	P2	A	B	C	D		A	B
SCDS 2D11	3.3	3.3	1.3	1.5	1.75	12	8	4	2	178	60	13	13.2	1500	1.3	1.7
SCDS 2D14	3.3	3.3	1.6	1.5	1.75	12	8	4	2	178	60	13	13.2	1000	1.3	1.7
SCDS2D18LD	3.3	3.3	1.9	1.5	1.75	12	8	4	2	178	60	13	13.2	1000	1.3	1.7
SCDS 2D18HP	3.3	3.3	1.9	1.5	1.75	12	8	4	2	178	60	13	13.2	1000	1.3	1.7
SCDS 3D12	4.2	4.2	1.25	1.5	1.75	12	8	4	2	330	100	13	13.4	5000	4.6	1.6
SCDS 3D16	4.3	4.3	2.1	1.5	1.75	12	8	4	2	178	60	13	13.2	1000	1.4	2.4
SCDS 4D18	5.3	5.3	2.4	1.5	1.75	12	8	4	2	330	100	13	13.4	2000	1.9	1.5
SCDS 4D28	5.3	5.3	3.4	1.5	1.75	12	8	4	2	330	100	13	13.4	2000	1.9	1.5
SCDS 5D18	6.2	6.2	2.2	1.5	1.75	12	8	4	2	330	100	13	13.4	2000	2.15	2.0
SCDS 5D28	6.2	6.2	3.2	1.5	1.75	12	8	4	2	330	100	13	13.4	2000	2.15	2.0
SCDS 6D28	7.2	7.2	3.2	1.5	1.75	16	12	4	2	330	100	13	17.4	1500	2.65	2.0
SCDS 6D38	7.1	7.1	4.1	1.5	1.75	16	12	4	2	330	100	13	17.4	1000	2.65	2.0

Shielded SMD
Power Inductors

SCDS Series



PRODUCT IDENTIFICATION

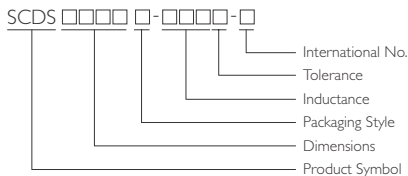

- T : Packing : Tape and Reel
- HP : Low DCR
- LD : High Power
- Tolerance : K=±10% M=±20% T=±30%
- CEC Internal No.: B: Silver plated terminals (3D12~6D38); S: Base type terminals (2D11~2D18HP & 62T&127)
- Note : YAGEO will start to release SCD Series inductor with lead-free terminals that meet SONY SS-00259's criterial for lead-free product in Q2 of 2004, and YAGEO Internal No will changed to "N" as identification.

SHAPES AND DIMENSIONS

Dimensions : mm

SCDS2D11/2D14/2D18LD/2D18HP

Shapes and Dimensions

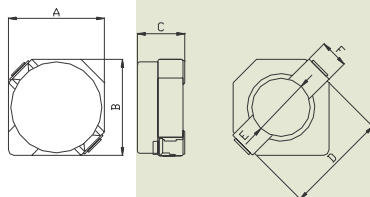

Dimensions in mm

TYPE	A	B	C	D	E	F
SCDS2D11	3.2 ⁺⁰	3.2 ⁺⁰	1.2 ⁺⁰	3.3	2.1	1.0
SCDS2D14	3.2 ⁺⁰	3.2 ⁺⁰	1.55 ⁺⁰	3.3	2.1	1.0
SCDS2D18LD	3.2 ⁺⁰	3.2 ⁺⁰	2.0 ⁺⁰	3.3	2.1	1.0
SCDS2D18HP	3.2 ⁺⁰	3.2 ⁺⁰	2.0 ⁺⁰	3.3	2.1	1.0

Recommended Pattern

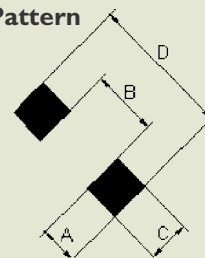

Dimensions in mm

TYPE	A	B	C	D
SCDS 2D11	1.3	1.7	1.3	4.3
SCDS 2D14	1.3	1.7	1.3	4.3
SCDS 2D18LD	1.3	1.7	1.3	4.3
SCDS 2D18HP	1.3	1.7	1.3	4.3

APPLICATIONS

- Power Supply for VTRs
- OA Equipment
- LCD Televisions
- Notebook PCs
- Portable Communication Equipment
- DC / DC Converters, etc.

FEATURES

- Available in Magnetically Dhielded
- Low DC Resistance
- Suitable for Large Currents
- Ideal for a Variety of DC – DC Converter Inductor Applications
- Available on Tape and Reel for Auto Surface Mounting



SHAPES AND DIMENSIONS

Dimensions : mm

SCDS 3D12

Shapes and Dimensions

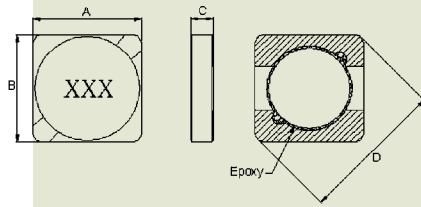

Recommended Pattern

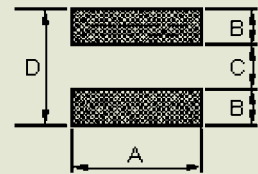

Dimensions in mm

TYPE	A	B	C	D
SCDS3D12	3.9 ± 0.2	3.9 ± 0.2	1.2 Max	6.2 Max

Dimensions in mm

TYPE	A	B	C	D
SCDS3D12	4.6	1.6	1.4	4.6

SCDS 3D16

Shapes and Dimensions

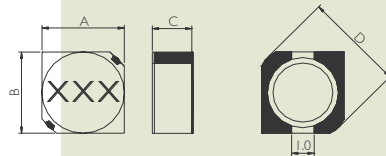

Recommended Pattern

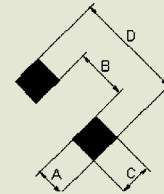

Dimensions in mm

TAPE	A	B	C	D
SCDS3D16	4 Max.	4 Max.	1.8 Max.	5.2 Max.

Dimensions in mm Recommended Pattern

TYPE	A	B	C	D
SCDS3D16	1.4	2.4	1.5	5.2

SCDS 4D18~6D38

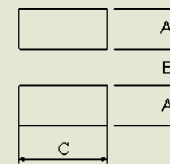
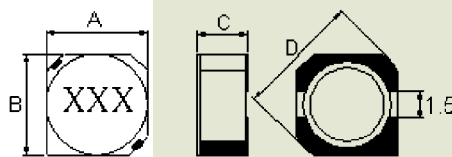

Dimensions in mm

TAPE	A	B	C	D
SCDS4D18	4.7 ± 0.3	4.7 ± 0.3	2.0 Max	6.9 Max
SCDS4D28	4.7 ± 0.3	4.7 ± 0.3	3.0 Max	6.9 Max

Dimensions in mm

TYPE	A	B	C
SCDS 4D18	1.9	1.5	5.3
SCDS 4D28	1.9	1.5	5.3

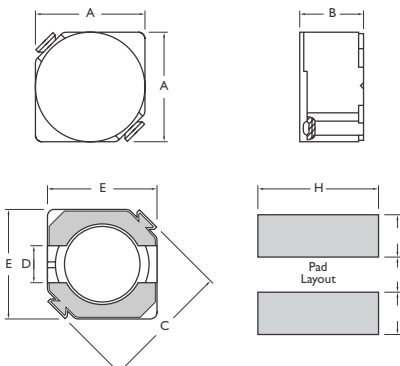

ITEM	A	B	C	D	E	H	I	J
5D18	5.7 ± 0.3	3.0 Max.	8.2 Max.	1.5	5.7±0.3	6.3	2.15	2.0
5D28	5.7 ± 0.3	3.0 Max.	8.2 Max.	1.5	5.7±0.3	6.3	2.15	2.0
6D28	6.7 ± 0.3	3.0 Max.	9.5 Max.	1.5	6.7±0.3	7.3	2.65	2.0
6D38	7.0 ± 0.0	4.0 Max.	9.5 Max.	1.5	7.0±0.0	7.3	2.65	2.0



TYPICAL ELECTRICAL CHARACTERISTICS

Curves of SCD Series

Test Instruments : HP4291A Impedance / Material Analyzer

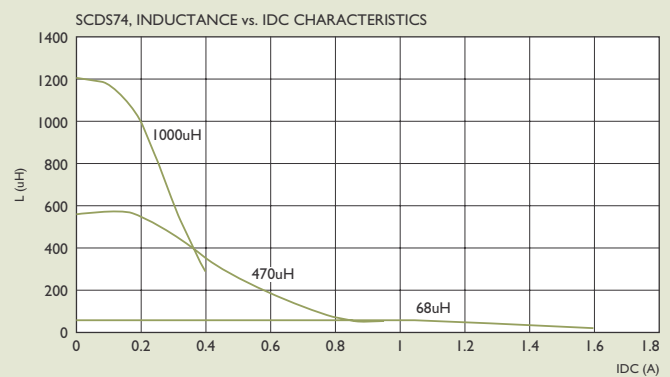
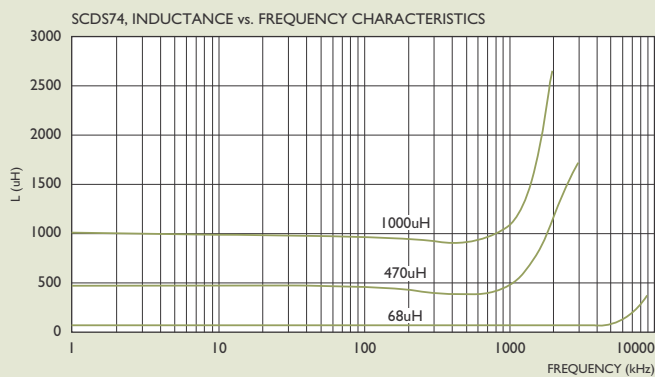
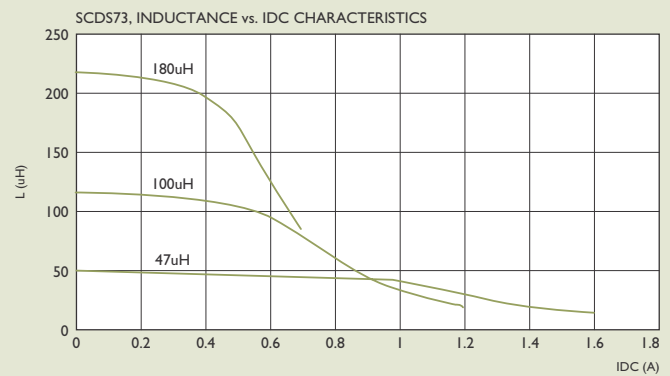
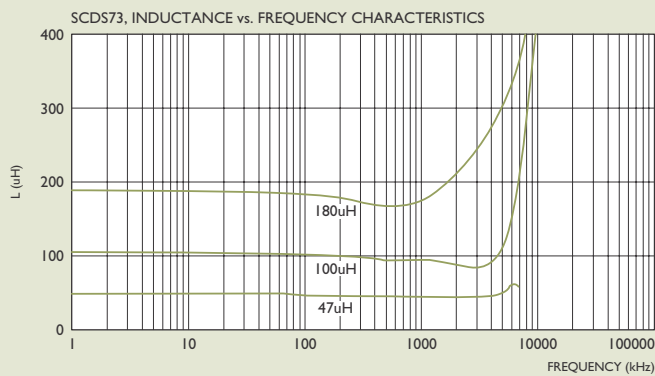
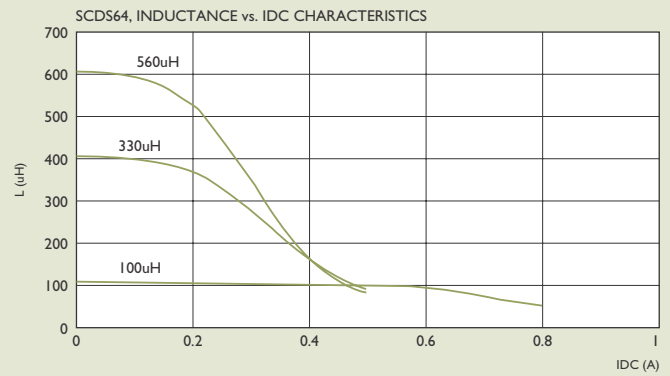
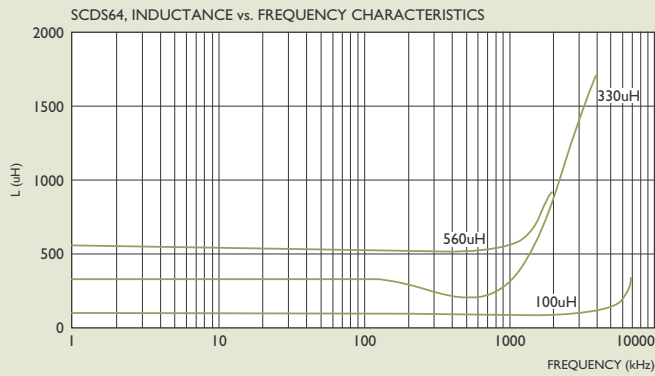
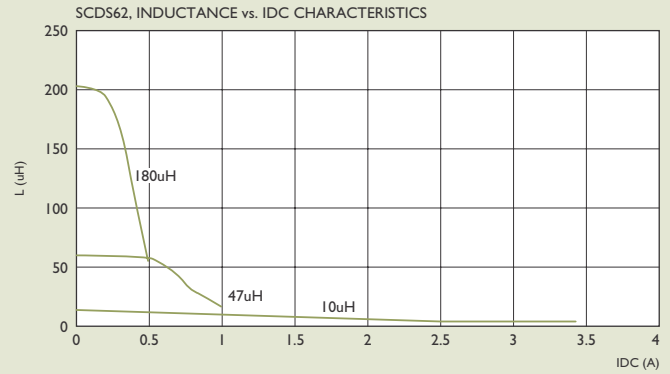
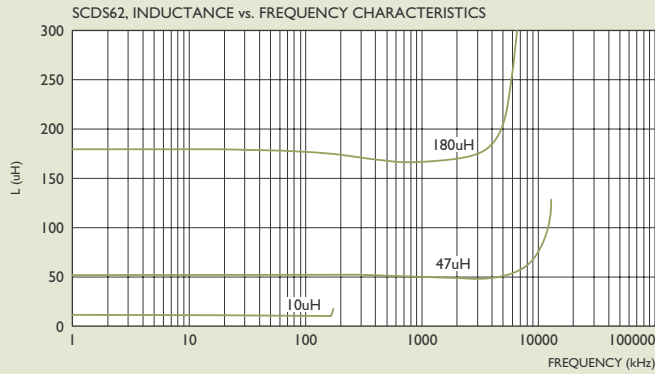



TYPICAL ELECTRICAL CHARACTERISTICS

Curves of SCD Series

Test Instruments : HP4291A Impedance / Material Analyzer

SCDS104R-220MS, INDUCTANCE vs. FREQUENCY CHARACTERISTICS

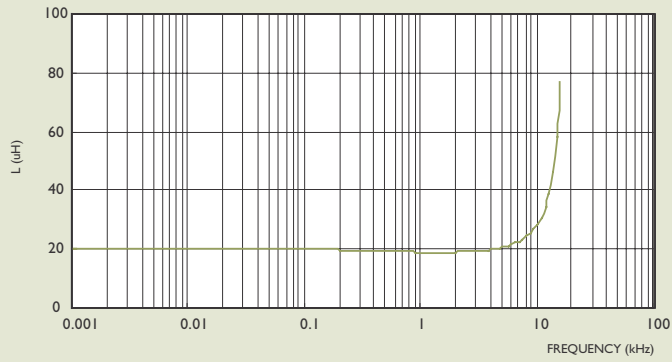

SCDS104R-220M-S

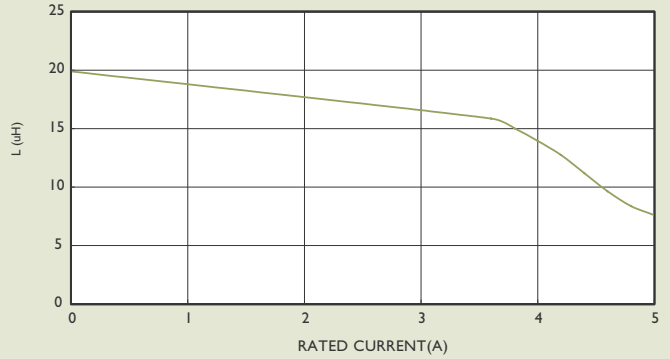

SCDS124, INDUCTANCE vs. FREQUENCY CHARACTERISTICS

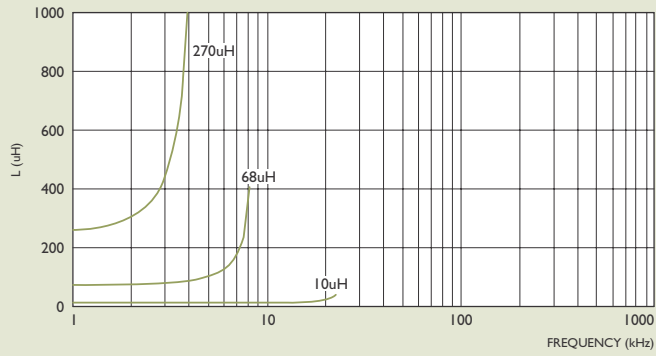

SCDS124, INDUCTANCE vs. IDC CHARACTERISTICS

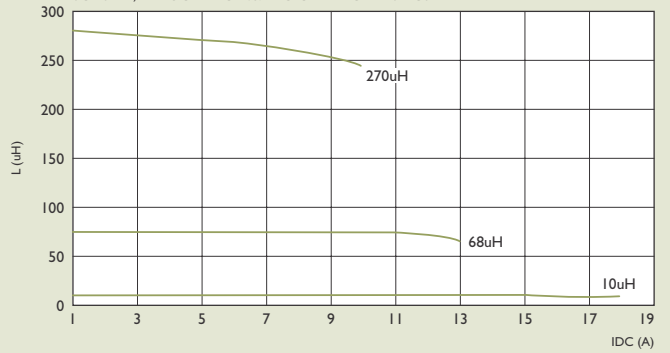

SCDS125, INDUCTANCE vs. FREQUENCY CHARACTERISTICS

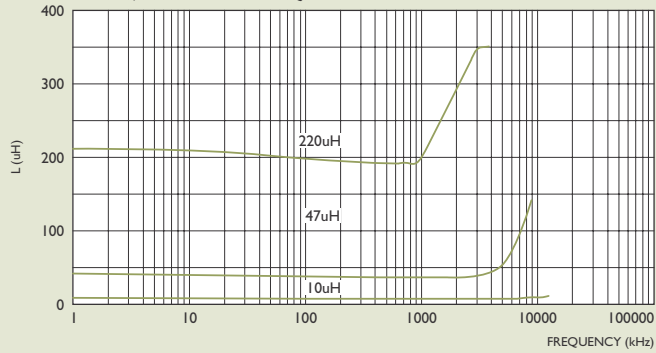

SCDS125, INDUCTANCE vs. IDC CHARACTERISTICS

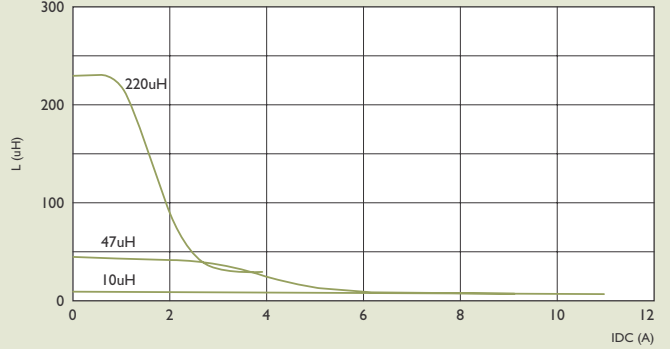

SCDS127, INDUCTANCE vs. FREQUENCY CHARACTERISTICS

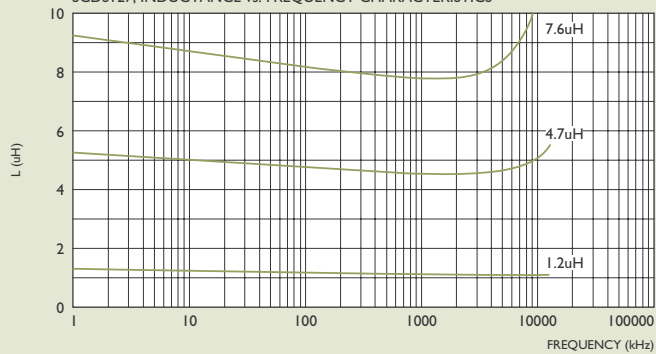

SCDS127, INDUCTANCE vs. IDC CHARACTERISTICS

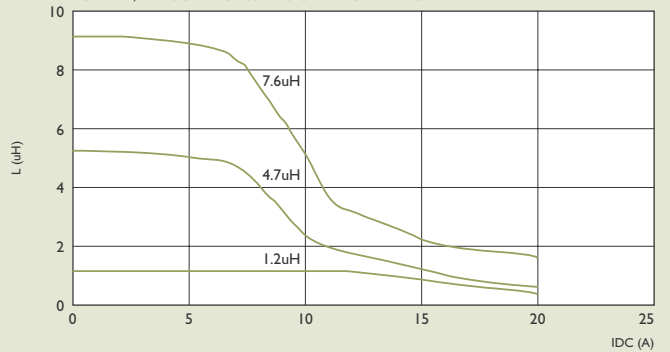



SCDS SERIES RELIABILITY TEST

I-1 MECHANICAL PERFORMANCE

NO.	ITEM	SPECIFICATION	TEST CONDITIONS
I-1-1	Vibration	Appearance : No Damage L Change : within $\pm 10\%$ Q Change : within $\pm 30\%$ RDC : within Specification	Test device shall be soldered on the substrate. Oscillation Frequency : 10 to 55 to 10Hz for 1Min. Amplitude : 1.5mm Time : 2Hrs. for each Axis (X,Y & Z), Total 6Hrs.
I-1-2	Resistance to Soldering Heat	Appearance : No Damage	Pre-heating : 150°C, 1Min. Solder Composition : Sn/Pb = 63/37 Solder Temperature : 260 \pm 5°C Immersion Time : 10 \pm 1Sec.
I-1-3	Solderability	The electrodes shall be at least 90% covered with new solder coating.	Pre-heating : 150°C, 1Min. Solder Composition : Sn/Pb = 63/37 Solder Temperature : 230 \pm 5°C Immersion Time : 4 \pm 1Sec.

I-2 ENVIRONMENTAL PERFORMANCE

NO.	ITEM	SPECIFICATION	TEST CONDITIONS															
I-2-1	Temperature Shock	Appearance : No Damage L Change : within $\pm 10\%$ L Change : within $\pm 30\%$ RDC : within Specification	10 Cycles (Air to Air) Cycles shall Consist of : 30Min. Exposure to -55°C 30Min. Exposure to -125°C 15Sec. Max. Transition between Temperatures Measured after Exposure in the Room Condition for 24Hrs.															
I-2-2	Temperature Cycle		One Cycle <table border="1"><thead><tr><th>Step</th><th>Temperature (°C)</th><th>Time (Min.)</th></tr></thead><tbody><tr><td>1</td><td>-25 \pm 3</td><td>30</td></tr><tr><td>2</td><td>25 \pm 2</td><td>3</td></tr><tr><td>3</td><td>85 \pm 3</td><td>30</td></tr><tr><td>4</td><td>25 \pm 2</td><td>3</td></tr></tbody></table> Total : 100 Cycles Measured after Exposure in the Room Condition for 24Hrs.	Step	Temperature (°C)	Time (Min.)	1	-25 \pm 3	30	2	25 \pm 2	3	3	85 \pm 3	30	4	25 \pm 2	3
Step	Temperature (°C)	Time (Min.)																
1	-25 \pm 3	30																
2	25 \pm 2	3																
3	85 \pm 3	30																
4	25 \pm 2	3																
I-2-3	Humidity Resistance		Temperature : 40 \pm 2°C Relative Humidity : 90 ~ 95% Time : 1000Hrs. Measured after Exposure in the Room Condition for 24Hrs.															
I-2-4	High Temperature Resistance		Temperature : 85 \pm 3°C Relative Humidity : 20% Applied Current : Rated Current Time : 1000Hrs. Measured after Exposure in the Room Condition for 24Hrs.															
I-2-5	Low Temperature Resistance		Temperature : -25 \pm 3°C Relative Humidity : 0% Time : 1000Hrs. Measured after Exposure in the Room Condition for 24Hrs.															

SMD Unshielded Power Inductors

SCMD Series



PRODUCT IDENTIFICATION

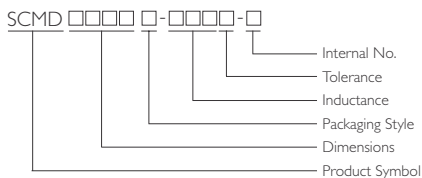

- Packaging: T: Tape and Reel
- Tolerance: M±20%
- Note: YAGEO will start to release SCMD Series inductors with lead-free terminals that meet SONY SS-00259's criteria for lead-free product in Q2 of 2004, and YAGEO Internal No. will be changed to "N" as identification. Ex.: SCMD4D06T-2R2

SHAPES AND DIMENSIONS

SCMD 4D06 & 4D08

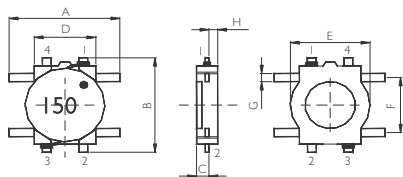

SCMD 4D11 & 4D13

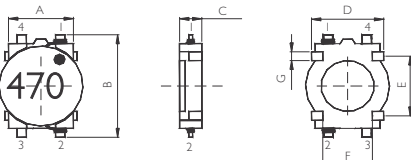

SCMD 5D11 & 5D13

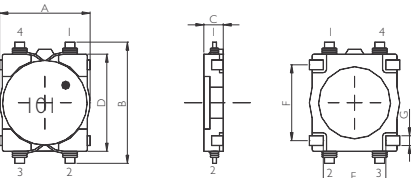

SCMD Series

Low DC Resistance & For Large Current Applications

Applications

- power supply for VTRs.
- OA equipment.
- LCD televisions.
- Notebook PCs.
- Portable communication equipment.
- DC / DC converters, etc.

Features

- Available in magnetically shielded.
- Low DC resistance.
- Suitable for large currents.
- Ideal for a variety of DC - Dc converter inductor applications.
- Available on tape and reel for auto surface mounting

Recommended Pattern

SCMD 4D06 & 4D08

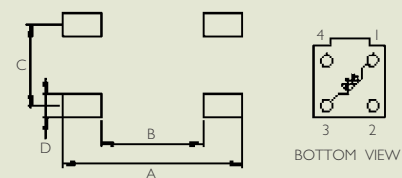

SCMD 4D11 & 4D13

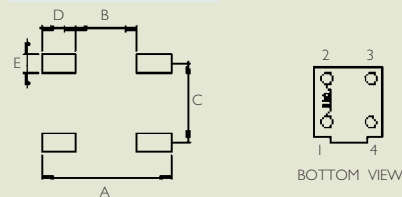

SCMD 5D11

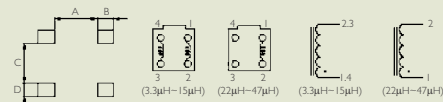

SCMD 5D13

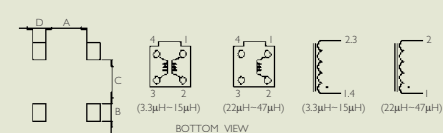

SHAPES AND DIMENSIONS

Dimensions : mm

TYPE	A	B	C	D	E	F	G	H	Recommended Pattern					
	Max	Max	Max						TYPE	A	B	C	D	E
SCMD4D06	6.3	5.8	0.8	3.5	4.1	3.2	0.5	0.4	SCMD4D06	7	4	3.2	0.9	
SCMD4D08	6.3	5.8	1.0	3.5	4.1	3.2	0.5	0.4	SCMD4D08	7	4	3.2	0.9	
SCMD4D11	4.4	5.8	1.25	3.7	3.2	2.9	0.5		SCMD4D11	5.3	2.5	3.2	1.4	0.8
SCMD4D13	4.4	5.8	1.45	3.7	3.2	2.9	0.5		SCMD4D13	5.3	2.5	3.2	1.4	0.8
SCMD5D11	5.8	7.4	1.2	6.0	4.2	4.5	0.6		SCMD5D11	3.6	1.4	3.4	1.1	
SCMD5D13	5.8	7.4	1.5	6.0	4.2	4.5	0.6		SCMD5D13	3.6	1.4	3.6	1.1	

Recommended Pattern

Dimensions : mm



STANDARD SPECIFICATIONS

Stamp	Inductance (μ H)	D.C.R(Ω) Max.						Rated D.C. Current(A)					
		SCMD 4D06	SCMD 4D08	SCMD 4D11	SCMD 4D13	SCMD 5D11	SCMD 5D13	SCMD 4D06	SCMD 4D08	SCMD 4D11	SCMD 4D13	SCMD 5D11	SCMD 5D13
2R2	2.2	0.116		0.116				0.95		0.95			
3R3	3.3	0.174	0.160	0.174	0.160	0.109	0.081	0.77	0.85	0.77	0.85	0.94	1.25
4R7	4.7	0.216	0.194	0.216	0.194	0.156	0.106	0.75	0.80	0.75	0.80	0.80	1.20
6R8	6.8	0.296	0.276	0.296	0.276	0.216	0.144	0.62	0.65	0.62	0.65	0.65	0.90
100	10	0.457	0.335	0.457	0.335	0.275	0.187	0.50	0.57	0.50	0.57	0.54	0.85
150	15	0.676	0.508	0.676	0.508	0.438	0.300	0.40	0.45	0.40	0.45	0.40	0.57
220	22	1.066	0.766	1.066	0.766	0.663	0.431	0.30	0.37	0.30	0.37	0.36	0.54
330	33	1.647	1.162	1.647	1.162	0.975	0.637	0.24	0.28	0.24	0.28	0.32	0.28
470	47	2.843	1.658	2.843	1.658	1.38	0.875	0.18	0.22	0.18	0.22	0.26	0.35
680	68		2.534		2.534	1.70			0.18		0.18	0.23	
101	100		3.800		3.800	2.80			0.17		0.17	0.20	
151	150				5.362						0.13		

• Measuring Frequency (L) : 100KHz

• Tolerance of Inductance: $\pm 20\%$ (M)

• Rated D.C Current (SCMD4D06/4D08/4D11/4D13/5D11)

This indicates the value of current when the inductance is 10% lower than its initial value at D.C superposition or D.C current when at $\Delta t=40^{\circ}\text{C}$ whichever is lower.

• Rated D.C Current (SCMD5D13)

This indicates the value of current when the inductance is 65% more than its nominal value and the temperature is rising at $\Delta t=40^{\circ}\text{C}$ lower at D.C superposition.

• Test Equipment:

L: HP4192. LF Impedance Analyzer or HP4284A.

DCR: CHEN HWA 502

Rared dc Current: HP4284A+HP42841A

SDS0402 Series

SMD Power Inductors

Features

- Smallest size and high performance
- High energy storage and very low resistance.



Applications

- Notebook computers, step-up and step-down converters.
- Flash memory programmers, etc...

PRODUCT IDENTIFICATION

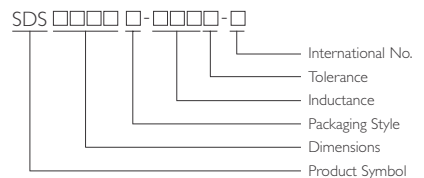

- Packaging: T: Tape and Reel
- Tolerance: $M \pm 20\%$
- Note: YAGEO will start to release SDS Series inductors with lead-free terminals which meet SONY SS-00259's criteria for lead-free product in Q2 of 2004, and YAGEO International No. will be changed to "N" as identification. Ex.: SDS0402BL-101M-N.

SHAPE AND DIMENSIONS

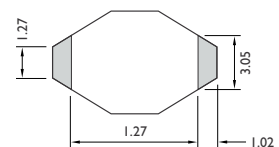
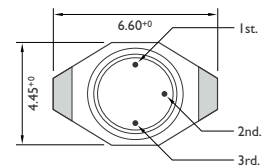

Dimensions : mm

These shielded ultra-miniature inductors can help designers achieving significantly longer battery life in handheld communication devices and other portable products.

The SDS0402 Series offers the highest efficiency, smallest size and lowest cost of any comparable part. DC resistance is 10% to 60% lower than other inductors, with greatest efficiency improvements seen at inductance values from 100 to 10,000 μ H.

These magnetically shielded inductors are designed with a flat top and constructed of heat resistant materials to ensure trouble-free assembly and reflow operations.

ELECTRICAL CHARACTERISTICS

PART NO.	INDUCTANCE (μ H \pm 20%) *	Q Min.	Q FREQUENCY (KHz)	DC RESISTANCE (Ω ⁺⁰) Max.	SRF (MHz)	CURRENT (A) Max. **
SDS0402T-1R0M-S	1.0	30	200	0.040	200	3.0
SDS0402T-1R5M-S	1.5	30	200	0.045	100	2.8
SDS0402T-2R2M-S	2.2	40	200	0.050	90	1.8
SDS0402T-3R3M-S	3.3	40	200	0.060	90	1.6
SDS0402T-4R7M-S	4.7	40	200	0.065	80	1.4
SDS0402T-6R8M-S	6.8	40	200	0.070	40	1.2
SDS0402T-100M-S	10	40	200	0.075	30	1.0
SDS0402T-150M-S	15	40	100	0.090	25	0.80
SDS0402T-220M-S	22	40	100	0.110	20	0.70
SDS0402T-330M-S	33	40	100	0.190	15	0.60
SDS0402T-470M-S	47	40	100	0.230	15	0.50
SDS0402T-680M-S	68	40	100	0.290	10	0.40
SDS0402T-101M-S	100	40	100	0.480	8	0.30
SDS0402T-151M-S	150	40	100	0.590	7	0.26
SDS0402T-221M-S	220	40	100	0.770	4	0.22
SDS0402T-331M-S	330	40	100	1.4	4	0.20
SDS0402T-471M-S	470	40	100	1.8	3	0.19
SDS0402T-681M-S	680	40	100	2.2	2	0.18
SDS0402T-102M-S	1000	40	100	3.4	1	0.15
SDS0402T-152M-S	1500	50	100	4.2	1	0.12
SDS0402T-222M-S	2200	50	100	8.5	1	0.10
SDS0402T-332M-S	3300	50	100	11	0.5	0.08
SDS0402T-472M-S	4700	50	100	13.9	0.5	0.06
SDS0402T-682M-S	6800	50	100	25	0.5	0.04
SDS0402T-103M-S	10000	50	100	32.8	0.4	0.02

* Inductance Tested at 0.1 Vrms, 100KHz

** 30°C Temperature Rise

Operating Temperature Range -40°C to +85°C

Shielded SMD Power Inductors

SDS0402BL Series

Features

- Smallest size and high performance
- High energy storage and very low resistance.



PRODUCT IDENTIFICATION

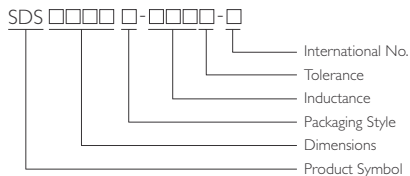

- Packaging: T: Tape and Reel
- Tolerance: M±20%
- Note: YAGEO will start to release SDS Series inductors with lead-free terminals which meet SONY SS-00259's criteria for lead-free product in Q2 of 2004, and YAGEO International No. will be changed to "N" as identification. Ex.: SDS0402BL-101M-N.

SHAPE AND DIMENSIONS

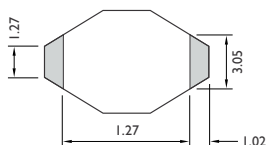
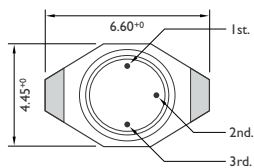

Dimensions : mm

Applications

- Notebook computers, step-up and step-down converters.
- Flash memory programmers, etc...

These shielded ultra-miniature inductors can help designers achieving significantly longer battery life in handheld communication devices and other portable products.

The SDS0402BL Series offers the highest efficiency, smallest size and lowest cost of any comparable part. DC resistance is 10% to 60% lower than other inductors, with greatest efficiency improvements seen at inductance values from 100 to 10,000 μ H.

These magnetically shielded inductors are designed with a flat top and constructed of heat resistant materials to ensure trouble-free assembly and reflow operations.

ELECTRICAL CHARACTERISTICS

PART NO.	INDUCTANCE (mH) *	TOLERANCE (±%)	DC RESISTANCE (Ω^{*6}) Max.	INSULATION CORE-WINDING (M Ω)	SRF (MHz)	CURRENT (mA) Max. **
SDS0402BL-101M-S	0.10	20	0.95	> 10	12	220
SDS0402BL-151M-S	0.15	20	1.4	> 10	10	200
SDS0402BL-221M-S	0.22	20	1.7	> 10	8	180
SDS0402BL-331M-S	0.33	20	2.2	> 10	6	160
SDS0402BL-471M-S	0.47	20	3.8	> 10	5	140
SDS0402BL-681M-S	0.68	20	4.9	> 10	4	120
SDS0402BL-102M-S	1.0	20	9	> 10	2	100
SDS0402BL-152M-S	1.5	20	11	> 10	1	80
SDS0402BL-222M-S	2.2	20	19	> 10	1	50
SDS0402BL-332M-S	3.3	20	24	> 10	1	40
SDS0402BL-472M-S	4.7	20	30	> 10	1	30
SDS0402BL-682M-S	6.8	20	56	> 10	0.9	20
SDS0402BL-103M-S	10.0	20	74	> 10	0.8	10

* Inductance Tested at 0.1 Vrms, 100KHz

** 30°C Temperature Rise

Operating Temperature Range -40°C to +85°C

Electrical Specifications at 25°C

SDS0804 Series

SMD Power Inductors

Features

- Smallest size and high performance
- High energy storage and very low resistance.



PRODUCT IDENTIFICATION

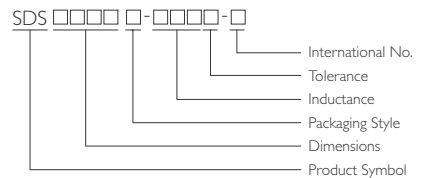

- Packaging: T: Tape and Reel
- Tolerance: $M \pm 20\%$
- Note: YAGEO will start to release SDS Series inductors with lead-free terminals which meet SONY SS-00259's criteria for lead-free product in Q2 of 2004, and YAGEO International No. will be changed to "N" as identification. Ex.: SDS0402BL-101M-N.

SHAPE AND DIMENSIONS

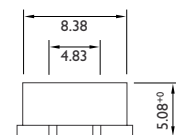
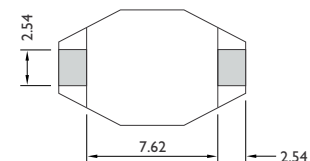
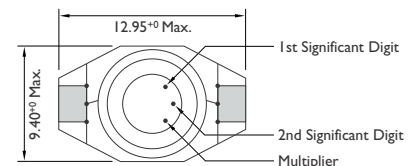

Dimensions : mm

These shielded ultra-miniature inductors can help designers achieving significantly longer battery life in handheld communication devices and other portable products.

These magnetically shielded inductors are designed with a flat top and constructed of heat resistant materials to ensure trouble-free assembly and reflow operations.

Applications

- Notebook computers, step-up and step-down converters.
- Flash memory programmers, etc...

ELECTRICAL CHARACTERISTICS

PART NO.	INDUCTANCE ($\mu\text{H} \pm 20\%$) *	DC RESISTANCE (Ω) Max.	Isat ** (A) Min.	Irms *** (A)	SRF (MHz)
SDS0804T-1R0M-S	1.0	0.021	5.6	5.0	110
SDS0804T-1R5M-S	1.5	0.022	5.2	4.5	90
SDS0804T-2R2M-S	2.2	0.032	5.0	3.8	60
SDS0804T-3R3M-S	3.3	0.039	3.9	3.3	55
SDS0804T-4R7M-S	4.7	0.054	3.2	2.7	30
SDS0804T-6R8M-S	6.8	0.075	2.8	2.2	30
SDS0804T-100M-S	10	0.101	2.4	2.0	28
SDS0804T-150M-S	15	0.150	2.0	1.5	20
SDS0804T-220M-S	22	0.207	1.6	1.3	15
SDS0804T-330M-S	33	0.334	1.4	1.1	12
SDS0804T-470M-S	47	0.472	1.0	0.8	10

* Inductance Tested at 0.1 Vrms, 100KHz

** Inductance Drop = 10% Typ. at Rated Isat.

*** 40° Rise Typ. at Irms.

Operating Temperature Range -40°C to +85°C

SMD Power Inductors

SDSI 306 Series

Features

- Smallest size and high performance
- High energy storage and very low resistance.



PRODUCT IDENTIFICATION

SDS □□□□ □-□□□□-□

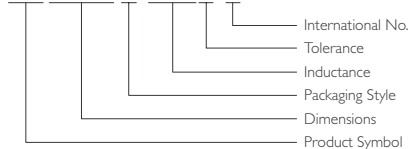

- Packaging: T: Tape and Reel
- Tolerance: $M \pm 20\%$
- Note: YAGEO will start to release SDS Series inductors with lead-free terminals which meet SONY SS-00259's criteria for lead-free product in Q2 of 2004, and YAGEO International No. will be changed to "N" as identification. Ex.: SDS0402BL-I01M-N.

SHAPE AND DIMENSIONS

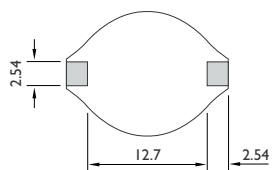
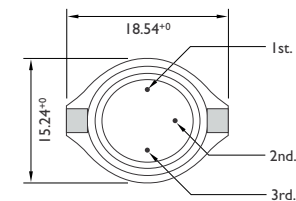

Dimensions : mm

Applications

- Notebook computers, step-up and step-down converters.
- Flash memory programmers, etc...

The SDSI 306 Series is a family of magnetically shielded power inductors designed for the higher current requirements of portable computers, Video recorders and other DC-DC conversion applications.

They feature saturation current ratings as high 9 Amps and rms current ratings up to 3.9 Amps. Low DC resistance (as low as .040 Ohms) keeps power losses to a minimum.

Designed specifically for surface mounting, the SDSI 306 has a flat top for reliable pick and place operations. The terminals wrap around the end of the base to ensure a sound solder fillet and simplify inspection.

ELECTRICAL CHARACTERISTICS

PART NO.	INDUCTANCE ($\mu\text{H} \pm 20\%$)*	DC RESISTANCE (Ω) Max.	Isat ** (A)	Irms *** (A)	SRF MHz ** (Ref.) Max.
SDSI 306T-100M-S	10	0.040	5.5	3.9	24
SDSI 306T-150M-S	15	0.048	4.5	3.4	16
SDSI 306T-220M-S	22	0.059	3.5	3.1	14
SDSI 306T-330M-S	33	0.075	3.3	2.8	11
SDSI 306T-470M-S	47	0.097	2.7	2.4	8.0
SDSI 306T-680M-S	68	0.138	2.2	2.0	7.0
SDSI 306T-101M-S	100	0.207	1.7	1.7	5.5
SDSI 306T-151M-S	150	0.293	1.3	1.3	4.8
SDSI 306T-221M-S	220	0.470	1.1	1.1	4.0
SDSI 306T-331M-S	330	0.780	0.86	0.86	3.0
SDSI 306T-471M-S	470	1.08	0.73	0.73	2.4
SDSI 306T-681M-S	680	1.40	0.64	0.64	2.0
SDSI 306T-102M-S	1000	2.01	0.53	0.53	1.0

* Inductance Tested at 0.1 Vrms, 100KHz

** Inductance Drop 10% Typ. at Isat.

*** 40°C Rise Typ. at Irms.

Operating Temperature Range -40°C to +85°C



TAPE DIMENSIONS

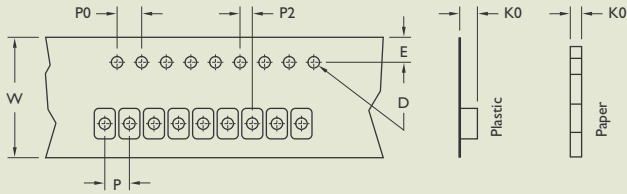

TAPE MATERIAL

Camer Tape : Polystyrene

Cover Type : Polyethylene

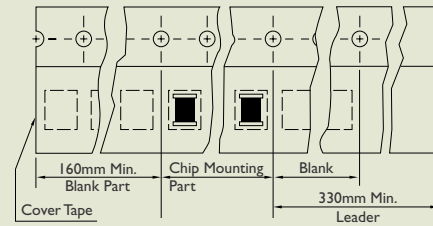

REEL DIMENSIONS

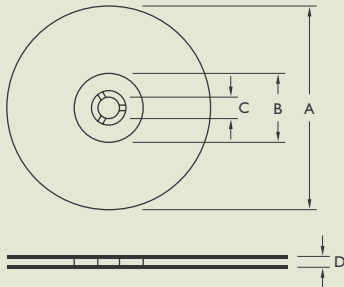

RECOMMENDED PATTERN

Land Pattern

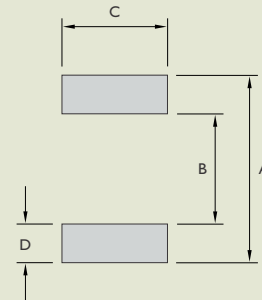

Dimensions : mm

TYPE	TAPE DIMENSIONS							RECOMMENDED PATTERN				REEL DIMENSIONS				QUANTITY (PCS/REEL)	
	K0	D	E	W	P	P0	P2	A	B	C	D	A	B	C	D	178	330
SDS0402BL	3.2	1.55	1.75	12	8	4	2	0.270	0.160	0.140	0.055	330	100	13	13.4	-	2500
								6.86	4.06	3.56	1.40	178	60		13.2	750	-
SDS0402T	3.2	1.55	1.75	12	8	4	2	6.86	4.06	3.56	1.40	330	100	13	13.4	-	2500
												178	60		13.2	750	-
SDS0804T	5.4	1.55	1.75	24	12	4	2	13.21	7.37	2.79	2.92	330	100	13	24.4	-	1000
SDS1306T	7.5	1.55	1.75	32	20	4	2	18.29	12.45	2.79	2.92	330	100	13	33.4	-	250



SDS SERIES RELIABILITY TEST

I-1 MECHANICAL PERFORMANCE

NO.	ITEM	SPECIFICATION	TEST CONDITIONS
I-1-1	Vibration	Appearance : No Damage L Change : within $\pm 10\%$ Q Change : within $\pm 30\%$ RDC : within Specification	Test device shall be soldered on the substrate. Oscillation Frequency : 10 to 55 to 10Hz for 1Min. Amplitude : 1.5mm Time : 2Hrs. for each Axis (X,Y & Z), Total 6Hrs.
I-1-2	Resistance to Soldering Heat	Appearance : No Damage	Pre-heating : 150°C, 1Min. Solder Composition : Sn/Pb = 63/37 Solder Temperature : 260 \pm 5°C Immersion Time : 10 \pm 1Sec.
I-1-3	Solderability	The electrodes shall be at least 90% covered with new solder coating.	Pre-heating : 150°C, 1Min. Solder Composition : Sn/Pb = 63/37 Solder Temperature : 230 \pm 5°C Immersion Time : 4 \pm 1Sec.

I-2 ENVIRONMENTAL PERFORMANCE

NO.	ITEM	SPECIFICATION	TEST CONDITIONS															
I-2-1	Temperature Shock	Appearance : No Damage L Change : within $\pm 10\%$ L Change : within $\pm 30\%$ RDC : within Specification	10 Cycles (Air to Air) Cycles shall Consist of : 30Min. Exposure to -55°C 30Min. Exposure to -125°C 15Sec. Max. Transition between Temperatures Measured after Exposure in the Room Condition for 24Hrs.															
I-2-2	Temperature Cycle		One Cycle <table border="1"> <thead> <tr> <th>Step</th> <th>Temperature (°C)</th> <th>Time (Min.)</th> </tr> </thead> <tbody> <tr> <td>1</td> <td>-25 \pm 3</td> <td>30</td> </tr> <tr> <td>2</td> <td>25 \pm 2</td> <td>3</td> </tr> <tr> <td>3</td> <td>85 \pm 3</td> <td>30</td> </tr> <tr> <td>4</td> <td>25 \pm 2</td> <td>3</td> </tr> </tbody> </table> Total : 100 Cycles Measured after Exposure in the Room Condition for 24Hrs.	Step	Temperature (°C)	Time (Min.)	1	-25 \pm 3	30	2	25 \pm 2	3	3	85 \pm 3	30	4	25 \pm 2	3
Step	Temperature (°C)	Time (Min.)																
1	-25 \pm 3	30																
2	25 \pm 2	3																
3	85 \pm 3	30																
4	25 \pm 2	3																
I-2-3	Humidity Resistance		Temperature : 40 \pm 2°C Relative Humidity : 90 ~ 95% Time : 1000Hrs. Measured after Exposure in the Room Condition for 24Hrs.															
I-2-4	High Temperature Resistance		Temperature : 85 \pm 3°C Relative Humidity : 20% Applied Current : Rated Current Time : 1000Hrs. Measured after Exposure in the Room Condition for 24Hrs.															
I-2-5	Low Temperature Resistance		Temperature : -25 \pm 3°C Relative Humidity : 0% Time : 1000Hrs. Measured after Exposure in the Room Condition for 24Hrs.															



TYPICAL ELECTRICAL CHARACTERISTICS

Curves of SCD Series

Test Instruments : HP4291A Impedance / Material Analyzer

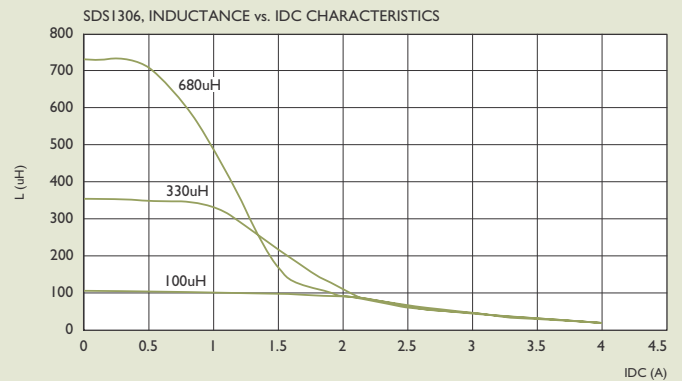
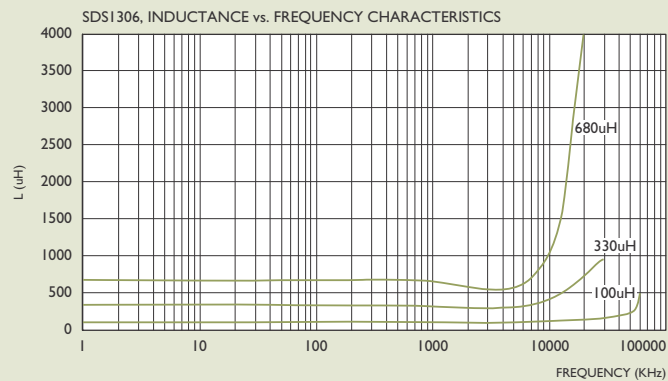
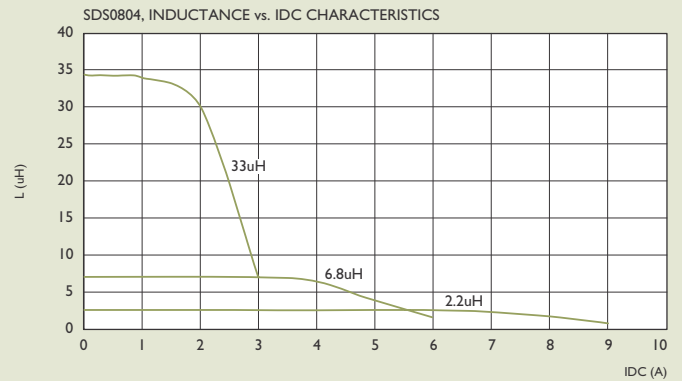
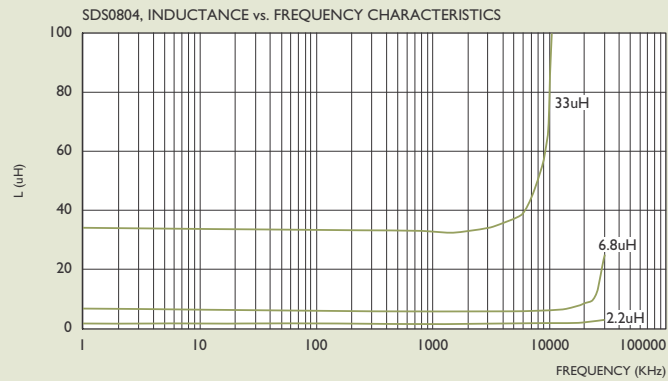
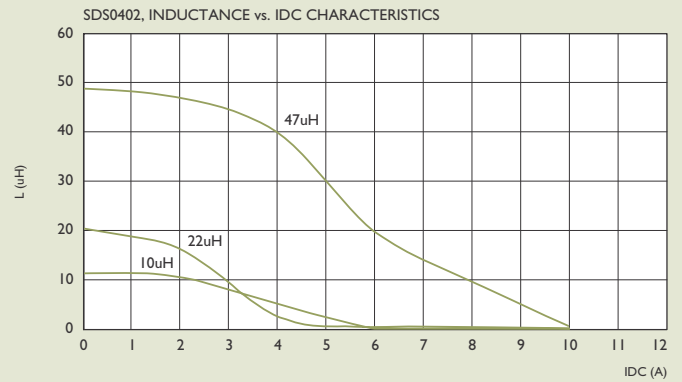
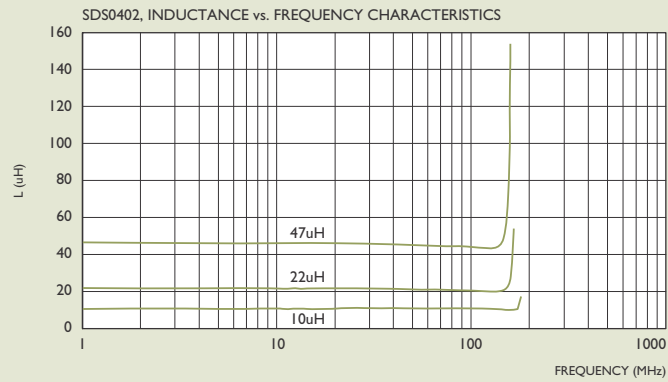

SMD Power Inductors

SLF Series



PRODUCT IDENTIFICATION

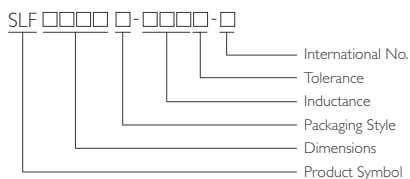

Features

- Low resistance and high currents

Designed for low – profile type with low Rdc and large current.

The magnetic shielded type is suitable for high density mounting.

Flat bottom surface allows for reliable mounting onto the board.

Soldering conditions can be easily confirmed when mounting onto the board.

Provide with embossed carrier type packaging for automatic mounting machine.

Applications

- Portable telephones, computers, hard disk drives and
- Other electronic equipment.

- Packaging: T :Tape and Reel
- Tolerance: M: $\pm 20\%$

- Note: YAGEO will start to release SLF Series inductors with lead-free terminals which meet SONY SS-00259's criteria for lead-free product in Q2 of 2004, and YAGEO Internal No will be changed to "N" as identification. Ex. SLF0628T-4R7M-N

SHAPES AND DIMENSIONS

Dimensions : mm

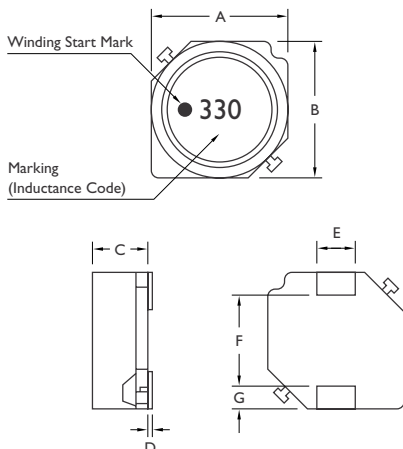

TYPE	A	B	C	D	E	F	G	WEIGHT GTYP
SLF0628	6 ± 0.3	6 ± 0.3	2.8 ± 0.3	0.5typ	2 ± 0.1	3.0 typ	1.5	0.3
SLF0728	7 ± 0.3	7 ± 0.3	2.8 ± 0.3	0.1typ	2 ± 0.1	4.0 typ	1.5	0.4
SLF0730	7 ± 0.3	7 ± 0.3	3.0 ± 0.3	0.1typ	2 ± 0.1	4.0 typ	1.5	0.4
SLF0732	7 ± 0.3	7 ± 0.3	3.2 ± 0.3	0.1typ	2 ± 0.1	4.0 typ	1.5	0.4
SLF0745	7 ± 0.3	7 ± 0.3	4.5 ± 0.3	0.1typ	2 ± 0.1	4.0 typ	1.5	0.6
SLF1045	10.1 ± 0.3	10.1 ± 0.3	4.5 ± 0.3	0.15typ	3 ± 0.1	6 ± 0.2	2 ± 0.15	1.3
SLF1255	12.5 ± 0.3	12.5 ± 0.3	5.5 ± 0.3	0.1typ	3 ± 0.1	8.6 ± 0.3	2 ± 0.15	2.4
SLF1265	12.5 ± 0.3	12.5 ± 0.3	6.5 ± 0.35	0.1typ	3 ± 0.1	8.6 ± 0.3	2 ± 0.15	2.8
SLF1275	12.5 ± 0.3	12.5 ± 0.3	7.5 ± 0.35	0.1typ	3 ± 0.1	8.6 ± 0.3	2 ± 0.15	3.3



ELECTRICAL CHARACTERISTICS SLF0628 SERIES

PART NO.	INDUCTANCE (μ H)	TOLERANCE (\pm %)	TEST FREQUENCY L(KHz)	DC RESISTANCE (Ω) \pm 20%	RATED CURRENT (A) Max.	ITEMP (A) Max.
SLF0628T-4R7M-S	4.7	20	1	0.0284	1.6	2.5
SLF0628T-6R8M-S	6.8	20	1	0.0354	1.5	2.2
SLF0628T-100M-S	10	20	1	0.0532	1.3	1.8
SLF0628T-150M-S	15	20	1	0.0745	1.0	1.4
SLF0628T-220M-S	22	20	1	0.104	0.77	1.3
SLF0628T-330M-S	33	20	1	0.148	0.69	1.1
SLF0628T-470M-S	47	20	1	0.21	0.59	0.92
SLF0628T-680M-S	68	20	1	0.29	0.50	0.78
SLF0628T-101M-S	100	20	1	0.43	0.42	0.64

IDC Current : Value obtained when DC current flows and the initial value of inductance has fallen by 30%.

Itemp Current : Value obtained when current flows and the temperature has risen to 25°C.

Test Equipment Inductance : HP4192A LF Impedance Analyzer or Equivalent (Test Frequency : 1KHz/0.5V)
RDC : SC-7401 Digital Multimeter ,or Equivalent

ELECTRICAL CHARACTERISTICS SLF0728 SERIES

PART NO.	INDUCTANCE (μ H)	TOLERANCE (\pm %)	TEST FREQUENCY L(KHz)	DC RESISTANCE (Ω) \pm 20%	RATED CURRENT (A) Max.
SLF0728T-3R3M-S	3.3	20	1	0.037	1.6
SLF0728T-4R7M-S	4.7	20	1	0.045	1.5
SLF0728T-6R8M-S	6.8	20	1	0.059	1.3
SLF0728T-100M-S	10	20	1	0.083	1.1
SLF0728T-150M-S	15	20	1	0.13	0.88
SLF0728T-220M-S	22	20	1	0.18	0.75
SLF0728T-330M-S	33	20	1	0.24	0.65
SLF0728T-470M-S	47	20	1	0.34	0.54

IDC current : Value obtained when DC current flows and the initial value of inductance has fallen by 10%.

Test equipment Inductance : HP4192A LF Impedance Analyzer or Equivalent (Test Frequency : 1KHz/0.5V)
RDC : SC-7401 Digital Multimeter ,or Equivalent



ELECTRICAL CHARACTERISTICS SLF0730 SERIES

PART NO.	INDUCTANCE (μ H)	TOLERANCE (\pm %)	TEST FREQUENCY L(KHz)	DC RESISTANCE (Ω) \pm 20%	RATED CURRENT (A) Max.
SLF0730T-3R3M-S	3.3	20		0.023	1.8
SLF0730T-4R7M-S	4.7	20		0.036	1.6
SLF0730T-6R8M-S	6.8	20		0.041	1.5
SLF0730T-100M-S	10	20		0.053	1.3
SLF0730T-150M-S	15	20		0.084	1
SLF0730T-220M-S	22	20		0.11	0.86
SLF0730T-330M-S	33	20		0.16	0.65
SLF0730T-470M-S	47	20		0.24	0.57
SLF0730T-680M-S	68	20		0.31	0.49
SLF0730T-101M-S	100	20		0.45	0.35

IDC Current : Value obtained when DC current flows and the initial value of inductance has fallen by 10%.

Test Equipment Inductance : HP4192A LF Impedance Analyzer or Equivalent (Test Frequency : 1KHz/0.5V)

RDC : SC-7401 Digital Multimeter ,or Equivalent

ELECTRICAL CHARACTERISTICS SLF0732 SERIES

PART NO.	INDUCTANCE (μ H)	TOLERANCE (\pm %)	TEST FREQUENCY L(KHz)	DC RESISTANCE (Ω) \pm 20%	RATED CURRENT (A) Max.
SLF0732T-3R3M-S	3.3	20		0.023	1.9
SLF0732T-4R7M-S	4.7	20		0.036	1.7
SLF0732T-6R8M-S	6.8	20		0.041	1.6
SLF0732T-100M-S	10	20		0.053	1.4
SLF0732T-150M-S	15	20		0.075	1.1
SLF0732T-220M-S	22	20		0.11	0.96
SLF0732T-330M-S	33	20		0.16	0.75
SLF0732T-470M-S	47	20		0.24	0.67
SLF0732T-680M-S	68	20		0.31	0.59
SLF0732T-101M-S	100	20		0.45	0.45
SLF0732T-151M-S	150	20		0.65	0.37
SLF0732T-221M-S	220	20		1.05	0.29
SLF0732T-331M-S	330	20		1.67	0.22
SLF0732T-471M-S	470	20		2.05	0.2
SLF0732T-681M-S	680	20		3.15	0.16
SLF0732T-102M-S	1000	20		4.78	0.13

IDC current : Value obtained when DC current flows and the initial value of inductance has fallen by 10%.

Test Equipment Inductance : HP4192A LF Impedance Analyzer or Equivalent (Test Frequency : 1KHz/0.5V)

RDC : SC-7401 Digital Multimeter ,or Equivalent.



ELECTRICAL CHARACTERISTICS SLF0745 SERIES

PART NO.	INDUCTANCE (μ H)	TOLERANCE (\pm %)	TEST FREQUENCY L(KHz)	DC RESISTANCE (Ω) \pm 20%	RATED CURRENT (A) Max.	ITEMP (A) Max.
SLF0745T-3R3M-S	3.3	20	1	0.02	2.5	2.3
SLF0745T-4R7M-S	4.7	20	1	0.03	2	2.1
SLF0745T-6R8M-S	6.8	20	1	0.039	1.7	1.74
SLF0745T-100M-S	10	20	1	0.036	1.3	1.78
SLF0745T-150M-S	15	20	1	0.052	1.1	1.53
SLF0745T-220M-S	22	20	1	0.061	0.9	1.34
SLF0745T-330M-S	33	20	1	0.096	0.82	1.09
SLF0745T-470M-S	47	20	1	0.125	0.75	0.92
SLF0745T-680M-S	68	20	1	0.175	0.6	0.77
SLF0745T-101M-S	100	20	1	0.25	0.5	0.65
SLF0745T-151M-S	150	20	1	0.34	0.4	0.55
SLF0745T-221M-S	220	20	1	0.52	0.33	0.45
SLF0745T-331M-S	330	20	1	0.74	0.25	0.37
SLF0745T-471M-S	470	20	1	1.05	0.22	0.31
SLF0745T-681M-S	680	20	1	1.48	0.2	0.27
SLF0745T-102M-S	1000	20	1	2.28	0.14	0.25

IDC current : Value obtained when DC current flows and the initial value of inductance has fallen by 10%.

Itemp current : Value obtained when current flows and the temperature has risen to 20°C.

Test equipment Inductance : HP4192A LF Impedance Analyzer or Equivalent (Test Frequency : 1KHz/0.5V)

RDC : SC-7401 Digital Multimeter ,or Equivalent

ELECTRICAL CHARACTERISTICS SLF1045 SERIES

PART NO.	INDUCTANCE (μ H)	TOLERANCE (\pm %)	TEST FREQUENCY L(KHz)	DC RESISTANCE (Ω) \pm 20%	RATED CURRENT (A) Max.	ITEMP (A) Max.
SLF1045T-100M-S	10	20	1	0.0364	3	2.5
SLF1045T-150M-S	15	20	1	0.0472	2.4	2.2
SLF1045T-220M-S	22	20	1	0.0591	2.1	1.9
SLF1045T-330M-S	33	20	1	0.0815	1.6	1.7
SLF1045T-470M-S	47	20	1	0.1	1.4	1.5
SLF1045T-680M-S	68	20	1	0.14	1.2	1.3
SLF1045T-101M-S	100	20	1	0.2	1	1.1
SLF1045T-151M-S	150	20	1	0.35	0.79	0.81
SLF1045T-221M-S	220	20	1	0.47	0.65	0.7
SLF1045T-331M-S	330	20	1	0.68	0.54	0.58
SLF1045T-471M-S	470	20	1	1.03	0.47	0.47
SLF1045T-681M-S	680	20	1	1.6	0.38	0.38
SLF1045T-102M-S	1000	20	1	2.8	0.32	0.29
SLF1045T-152M-S	1500	20	1	3.4	0.22	0.26

IDC current : Value obtained when DC current flows and the initial value of inductance has fallen by 10%.

Itemp current : Value obtained when current flows and the temperature has risen to 30°C.

Test equipment Inductance : HP4192A LF Impedance Analyzer or Equivalent (Test Frequency : 1KHz/0.5V)

RDC : SC-7401 Digital Multimeter ,or Equivalent



ELECTRICAL CHARACTERISTICS SLFI255 SERIES

PART NO.	INDUCTANCE (μ H)	TOLERANCE (\pm %)	TEST FREQUENCY (KHz)	DC RESISTANCE (Ω) \pm 20%	RATED CURRENT (A) Max.	ITEMP (A) Max.
SLFI255T-6R0M-S	6	20		0.0164	3.6	4.9
SLFI255T-100M-S	10	20		0.0215	3.4	4.3
SLFI255T-150M-S	15	20		0.0259	2.8	3.9
SLFI255T-220M-S	22	20		0.0338	2.3	3.4
SLFI255T-330M-S	33	20		0.0415	1.9	3.1
SLFI255T-470M-S	47	20		0.0618	1.6	2.5
SLFI255T-680M-S	68	20		0.0832	1.3	2.2
SLFI255T-101M-S	100	20		0.117	1.1	1.8
SLFI255T-151M-S	150	20		0.19	0.88	1.4
SLFI255T-221M-S	220	20		0.27	0.72	1.2
SLFI255T-331M-S	330	20		0.41	0.59	1
SLFI255T-471M-S	470	20		0.52	0.49	0.88
SLFI255T-681M-S	680	20		0.76	0.43	0.73
SLFI255T-102M-S	1000	20		1.12	0.34	0.6
SLFI255T-152M-S	1500	20		1.73	0.29	0.48

IDC current : Value obtained when DC current flows and the initial value of inductance has fallen by 10%.

Itemp current : Value obtained when current flows and the temperature has risen to 30°C.

Test equipment Inductance : HP4192A LF Impedance Analyzer or Equivalent (Test Frequency : 1KHz/0.5V)

RDC : SC-7401 Digital Multimeter ,or Equivalent

ELECTRICAL CHARACTERISTICS SLFI265 SERIES

PART NO.	INDUCTANCE (μ H)	TOLERANCE (\pm %)	TEST FREQUENCY (KHz)	DC RESISTANCE (Ω) \pm 20%	RATED CURRENT (A) Max.	ITEMP (A) Max.
SLFI265T-2R0M-S	2	30		0.0117	10	6.2
SLFI265T-4R2M-S	4.2	30		0.015	7.3	5.5
SLFI265T-7R0M-S	7	30		0.0177	5.7	5
SLFI265T-100M-S	10	20		0.0202	5	4.8
SLFI265T-150M-S	15	20		0.0237	4.2	4.4
SLFI265T-220M-S	22	20		0.0316	3.5	3.8
SLFI265T-330M-S	33	20		0.0406	2.8	3.4
SLFI265T-470M-S	47	20		0.0578	2.4	2.8
SLFI265T-680M-S	68	20		0.0787	2	2.4
SLFI265T-101M-S	100	20		0.123	1.6	1.9
SLFI265T-221M-S	220	20		0.273	1	1.2

IDC current : Value obtained when DC current flows and the initial value of inductance has fallen by 10%.

Itemp current : Value obtained when current flows and the temperature has risen to 40°C.

Test equipment Inductance : HP4192A LF Impedance Analyzer or Equivalent (Test Frequency : 1KHz/0.5V)

RDC : SC-7401 Digital Multimeter ,or Equivalent



ELECTRICAL CHARACTERISTICS SLF1275 SERIES

PART NO.	INDUCTANCE (μ H)	TOLERANCE (\pm %)	TEST FREQUENCY (KHz)	DC RESISTANCE (Ω) \pm 20%	RATED CURRENT (A) Max.	ITEMP (A) Max.
SLF1275T-1R2M-S	1.2	30	1	0.0069	13	8.2
SLF1275T-2R7M-S	2.7	30	1	0.0094	10	7
SLF1275T-3R9M-S	3.9	30	1	0.0104	9	6.7
SLF1275T-5R6M-S	5.6	30	1	0.0116	7.8	6.3
SLF1275T-6R8M-S	6.8	30	1	0.0131	7.2	5.9
SLF1275T-100M-S	10	20	1	0.01872	5.5	5.4
SLF1275T-150M-S	15	20	1	0.0184	4.7	5
SLF1275T-220M-S	22	20	1	0.0263	4	4
SLF1275T-330M-S	33	20	1	0.0395	3.2	3.4
SLF1275T-470M-S	47	20	1	0.0528	2.7	3
SLF1275T-680M-S	68	20	1	0.0778	2	2.4
SLF1275T-101M-S	100	20	1	0.125	1.9	1.9
SLF1275T-151M-S	150	20	1	0.175	1.5	1.6
SLF1275T-221M-S	220	20	1	0.258	1.3	1.3

IDC Current : Value obtained when DC current flows and the initial value of inductance has fallen by 10%.

Itemp Current : Value obtained when current flows and the temperature has risen to 40°C.

Test Equipment Inductance : HP4192A LF Impedance Analyzer or Equivalent (Test Frequency : 1KHz/0.5V)

RDC : SC-7401 Digital Multimeter ,or Equivalent



TAPE DIMENSIONS

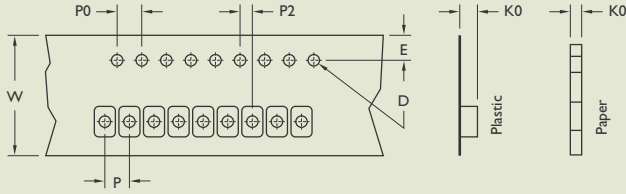

TAPE MATERIAL

Camer Tape : Polystyrene

Cover Type : Polyethylene

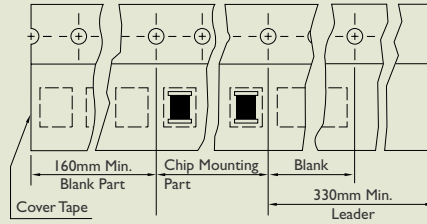

REEL DIMENSIONS

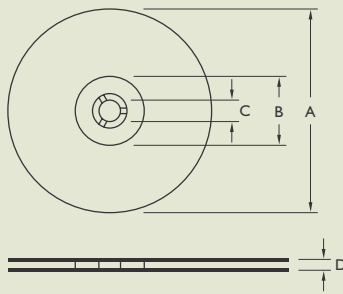

RECOMMENDED PATTERN

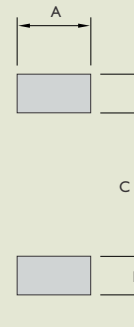

Dimensions : mm

TYPE	TAPE DIMENSIONS							RECOMMENDED PATTERN				REEL DIMENSIONS				QUANTITY PCS/REEL
	K0	D	E	W	P	P0	P2	A	B	C	D	A	B	C	D	
SLF0628	3.5	1.55	1.75	16	12	4	2	2.2	1.5	4	1.5	330	100	13	17.4	1000
SLF0728	3.5	1.55	1.75	16	12	4	2	2.2	1.5	4.9	1.5	330	100	13	17.4	1000
SLF0730	3.7	1.55	1.75	16	12	4	2	2.2	1.5	4.9	1.5	330	100	13	17.4	1000
SLF0732	4	1.55	1.75	16	12	4	2	2.2	1.5	4.9	1.5	330	100	13	17.4	1000
SLF0745	5.5	1.55	1.75	16	12	4	2	2.2	1.5	4.9	1.5	330	100	13	17.4	1000
SLF1045	5.5	1.55	1.75	24	24	4	2	3.2	2.5	5.6	2.5	330	100	13	24.4	500
SLF1255	6.5	1.55	1.75	24	24	4	2	3.2	2.5	8.6	2.5	330	100	13	24.4	500
SLF1265	7.5	1.55	1.75	24	24	4	2	3.2	2.5	8.6	2.5	330	100	13	24.4	500
SLF1275	8.5	1.55	1.75	24	24	4	2	3.2	2.5	8.6	2.5	330	100	13	24.4	500



SLF SERIES RELIABILITY TEST

I-1 MECHANICAL PERFORMANCE

NO.	ITEM	SPECIFICATION	TEST CONDITIONS
I-1-1	Vibration	Appearance : No Damage L Change : within $\pm 10\%$ Q Change : within $\pm 30\%$ RDC : within Specification	Test device shall be soldered on the substrate. Oscillation Frequency : 10 to 55 to 10Hz for 1Min. Amplitude : 1.5mm Time : 2Hrs. for each Axis (X,Y & Z), Total 6Hrs.
I-1-2	Resistance to Soldering Heat	Appearance : No Damage	Pre-heating : 150°C, 1Min. Solder Composition : Sn/Pb = 63/37 Solder Temperature : 260 \pm 5°C Immersion Time : 10 \pm 1Sec.
I-1-3	Solderability	The electrodes shall be at least 90% covered with new solder coating.	Pre-heating : 150°C, 1Min. Solder Composition : Sn/Pb = 63/37 Solder Temperature : 230 \pm 5°C Immersion Time : 4 \pm 1Sec.

I-2 ENVIRONMENTAL PERFORMANCE

NO.	ITEM	SPECIFICATION	TEST CONDITIONS															
I-2-1	Temperature Shock	Appearance : No Damage L Change : within $\pm 10\%$ L Change : within $\pm 30\%$ RDC : within Specification	10 Cycles (Air to Air) Cycles shall Consist of : 30Min. Exposure to -55°C 30Min. Exposure to 125°C 15Sec. Max. Transition between Temperatures Measured after Exposure in the Room Condition for 24Hrs.															
I-2-2	Temperature Cycle		One Cycle <table border="1"> <thead> <tr> <th>Step</th> <th>Temperature (°C)</th> <th>Time (Min.)</th> </tr> </thead> <tbody> <tr> <td>1</td> <td>-25 \pm 3</td> <td>30</td> </tr> <tr> <td>2</td> <td>25 \pm 2</td> <td>3</td> </tr> <tr> <td>3</td> <td>85 \pm 3</td> <td>30</td> </tr> <tr> <td>4</td> <td>25 \pm 2</td> <td>3</td> </tr> </tbody> </table> <p>Total : 100 Cycles Measured after Exposure in the Room Condition for 24Hrs.</p>	Step	Temperature (°C)	Time (Min.)	1	-25 \pm 3	30	2	25 \pm 2	3	3	85 \pm 3	30	4	25 \pm 2	3
Step	Temperature (°C)	Time (Min.)																
1	-25 \pm 3	30																
2	25 \pm 2	3																
3	85 \pm 3	30																
4	25 \pm 2	3																
I-2-3	Humidity Resistance		Temperature : 40 \pm 2°C Relative Humidity : 90 ~ 95% Time : 1000Hrs. Measured after Exposure in the Room Condition for 24Hrs.															
I-2-4	High Temperature Resistance		Temperature : 85 \pm 3°C Relative Humidity : 20% Applied Current : Rated Current Time : 1000Hrs. Measured after Exposure in the Room Condition for 24Hrs.															
I-2-5	Low Temperature Resistance		Temperature : -25 \pm 3°C Relative Humidity : 0% Time : 1000Hrs. Measured after Exposure in the Room Condition for 24Hrs.															

SMD Power Inductors

SDT0402 Series



Features

- Ultra high L and low current
- Functions equally well in filter and smoothing circuit applications.
- Available in 2 sizes.

PRODUCT IDENTIFICATION

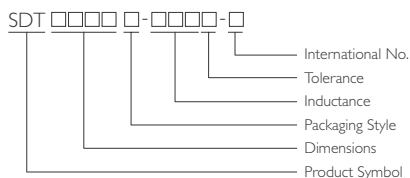

- Packaging: T: Tape and Reel
- Tolerance: M: $\pm 20\%$
- Note: YAGEO will start to release SDT Series inductors with lead-free terminals which meet SONY SS-00259's criteria for lead-free product in Q2 of 2004, and YAGEO Internal No will be changed to "N" as identification.
Ex. SDT0402T-1R0M-N

SHAPES AND DIMENSIONS

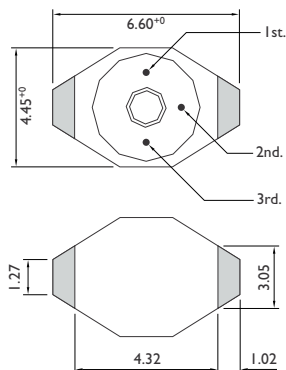

Dimensions : mm

Applications

- Board mounted DC-DC converters
- Miniature power supplies, and voltage multiplying circuits.

These inductors are designed for a wide variety of applications including board mounted DC-DC converters, miniature power supplies, and voltage multiplying circuits. They function equally well in filter and smoothing circuit applications.

The Yageo SDT Series represents the ultimate in cost effective miniature power inductors. They are constructed of materials specially developed for surface mount applications to ensure the best possible reliability and ease of using and handling.

Because of their " swinging " inductance vs. current characteristics, the SSL0402 Series can be used as ultra high L inductors at zero or low current.

SPECIFICATIONS

OPERATING PARAMETERS

PART NO.	INDUCTANCE @100KHz, 0 Adc ($\mu\text{H} \pm 20\%$)	DC RESISTANCE (Ω) Max.	INDUCTANCE RATING * (μH)	CURRENT RATING ** (A)	ENERGY STORAGE (μ Joules) Max.	SWITCHING FREQUENCY Max.	SRF (MHz)
SDT0402T-1R0M-S	1.0	0.045	0.60	2.0	1.8	1 MHz	157
SDT0402T-1R5M-S	1.5	0.050	0.80	1.9	1.8	1 MHz	108
SDT0402T-2R2M-S	2.2	0.060	0.90	1.5	1.8	1 MHz	92
SDT0402T-3R3M-S	3.3	0.070	1.5	1.2	1.4	1 MHz	69
SDT0402T-4R7M-S	4.7	0.080	2.0	1.2	1.6	1 MHz	59
SDT0402T-6R8M-S	6.8	0.085	3.0	1.0	1.9	1 MHz	51
SDT0402T-100M-S	10	0.095	5.0	0.7	1.2	1 MHz	33
SDT0402T-150M-S	15	0.135	6.0	0.6	1.1	1 MHz	26
SDT0402T-220M-S	22	0.160	10	0.5	1.2	1 MHz	20
SDT0402T-330M-S	33	0.275	12	0.45	1.5	1 MHz	17
SDT0402T-470M-S	47	0.340	20	0.34	1.3	1 MHz	12
SDT0402T-680M-S	68	0.575	30	0.29	1.4	1 MHz	11
SDT0402T-101M-S	100	1.100	40	0.24	1.5	1 MHz	9.4
SDT0402T-151M-S	150	1.400	60	0.20	1.4	500 KHz	6.7
SDT0402T-221M-S	220	2.250	90	0.17	1.6	500 KHz	6.1
SDT0402T-331M-S	330	2.900	100	0.16	1.4	500 KHz	4.7
SDT0402T-471M-S	470	3.600	150	0.14	1.5	500 KHz	3.85
SDT0402T-681M-S	680	4.550	200	0.12	1.4	500 KHz	3.1
SDT0402T-102M-S	1000	8.100	400	0.08	1.4	500 KHz	2.3

* Measured at the rated current. Refer to curves below for more detail.

** Average maximum allowable current. SDT Series inductors are designed for current spikes as high as 2X the current rating.

Operating Temperature Range -40°C to $+85^{\circ}\text{C}$



TYPICAL INDUCTANCE ENERGY STORAGE VS. CURRENT

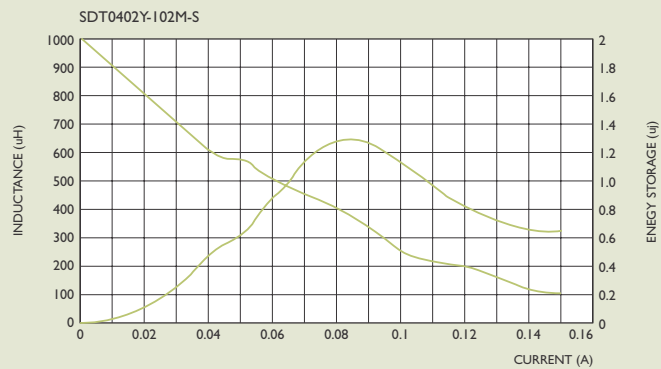
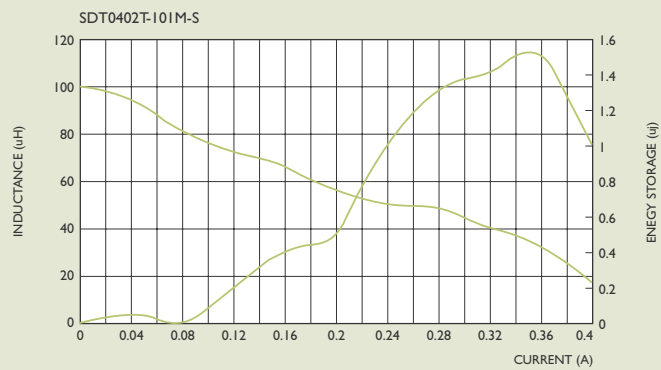
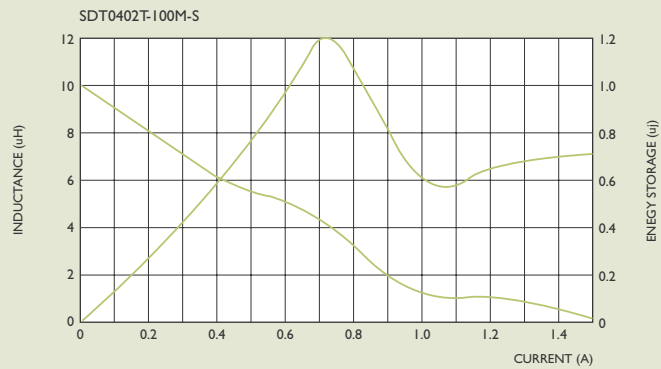
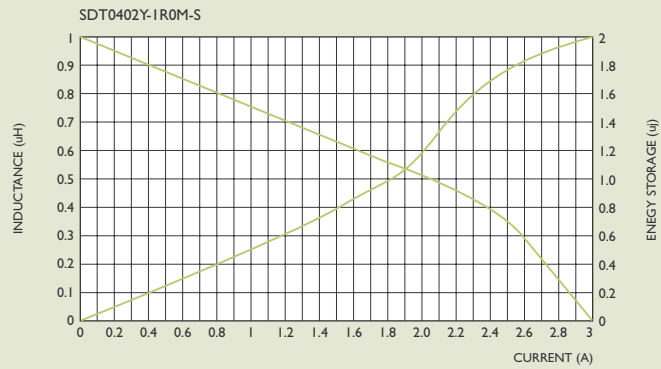

SMD Power Inductors

SDT0804 Series



Features

- Ultra high L and low current
- Functions equally well in filter and smoothing circuit applications.
- Available in 2 sizes.

PRODUCT IDENTIFICATION

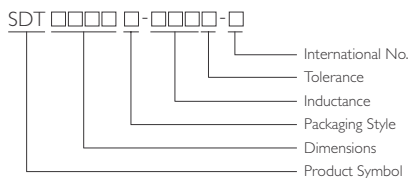

- Packaging: T: Tape and Reel
- Tolerance: M: $\pm 20\%$
- Note: YAGEO will start to release SDT Series inductors with lead-free terminals which meet SONY SS-00259's criteria for lead-free product in Q2 of 2004, and TAGEO Internal No will be changed to "N" as identification.
Ex. SDT0402T-1R0M-N

SHAPES AND DIMENSIONS

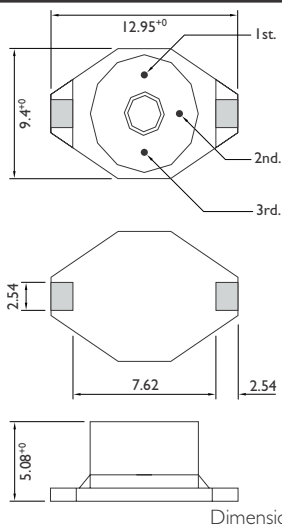

Applications

- Board mounted DC-DC converters
- Miniature power supplies, and voltage multiplying circuits.

These inductors are designed for a wide variety of applications including board mounted DC-DC converters, miniature power supplies, and voltage multiplying circuits. They function equally well in filter and smoothing circuit applications.

The Yageo SDT Series represents the ultimate in cost effective miniature power inductors. They are constructed of materials specially developed for surface mount applications to ensure the best possible reliability and ease of use and handling.

SPECIFICATIONS

PART NO.	OPERATING PARAMETERS						
	INDUCTANCE @100KHZ, 0 ADC ($\mu\text{H} \pm 20\%$)	DC RESISTANCE (Ω) Max.	SRF TYP (MHz)	INDUCTANCE RATING * (μH)	CURRENT RAGING ** (A)	ENERGY STORAGE (μJ JOULES) Max.	SWITCHING FREQUENCY Max.
SDT0804T-1R0M-S	1.0	0.025	60	0.50	5.0	9	1 MHz
SDT0804T-1R5M-S	1.5	0.030	55	0.70	5.0	12	1 MHz
SDT0804T-2R2M-S	2.2	0.035	55	1.00	5.0	15	1 MHz
SDT0804T-3R3M-S	3.3	0.040	50	1.50	5.0	16	1 MHz
SDT0804T-4R7M-S	4.7	0.045	45	2.00	3.0	10	1 MHz
SDT0804T-6R8M-S	6.8	0.050	40	4.00	2.5	14	1 MHz
SDT0804T-100M-S	10	0.055	35	5.00	2.0	11	1 MHz
SDT0804T-150M-S	15	0.060	25	6.00	1.8	12	1 MHz
SDT0804T-220M-S	22	0.084	22	10	1.5	11	1 MHz
SDT0804T-330M-S	33	0.090	18	12	1.3	13	1 MHz
SDT0804T-470M-S	47	0.11	16	27	1.0	13	1 MHz
SDT0804T-680M-S	68	0.15	12	40	0.90	17	1 MHz
SDT0804T-101M-S	100	0.29	9	50	0.80	15	1 MHz
SDT0804T-151M-S	150	0.36	8	80	0.60	15	500 KHz
SDT0804T-221M-S	220	0.39	6	90	0.50	10	500 KHz
SDT0804T-331M-S	330	0.73	5	150	0.40	13	500 KHz
SDT0804T-471M-S	470	0.88	4	200	0.35	13	500 KHz
SDT0804T-681M-S	680	1.15	3	300	0.30	13	500 KHz
SDT0804T-102M-S	1000	1.45	2.5	420	0.25	13	500 KHz

* Measured at the rated current. Refer to curves below for more detail.

** Average maximum allowable current. SDT Series inductors are designed for current spikes as high as 2X the current rating.

Operating Temperature Range -40°C to +85°C



TYPICAL INDUCTANCE ENERGY STORAGE VS. CURRENT

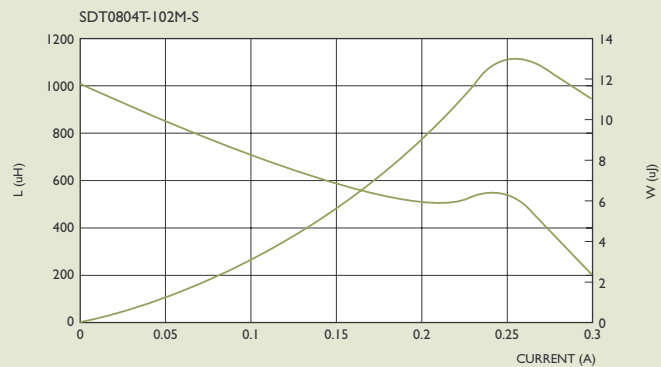
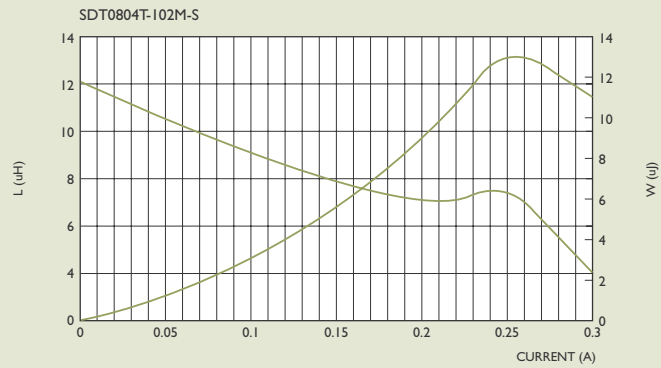
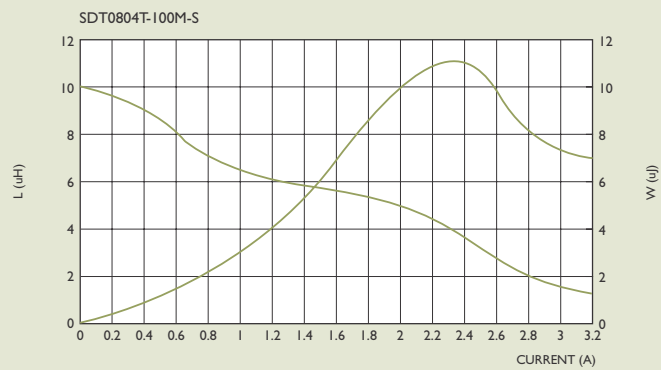
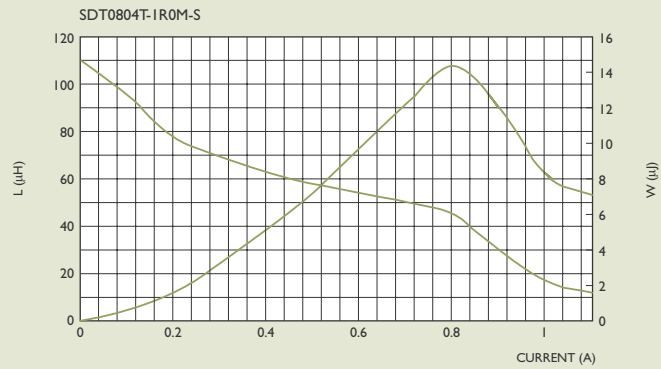



TAPE DIMENSIONS

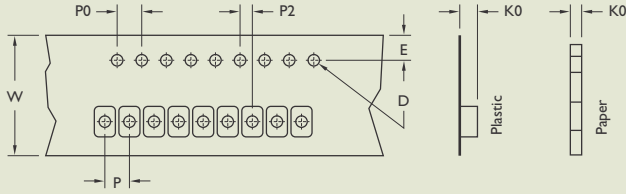

TAPE MATERIAL

Carrier Tape : Polystyrene

Cover Type : Polyethylene

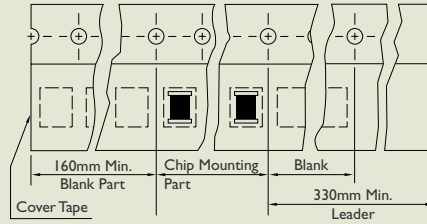

REEL DIMENSIONS

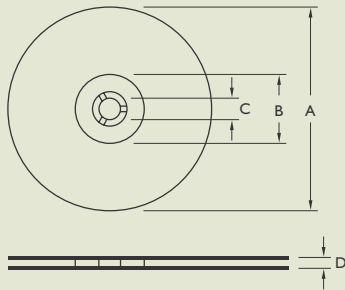

RECOMMENDED PATTERN

Land Pattern

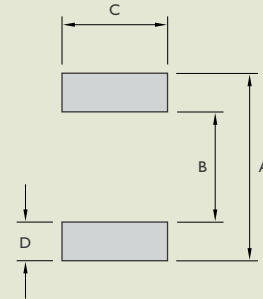

Dimensions : mm

TYPE	TAPE DIMENSIONS							RECOMMENDED PATTERN				REEL DIMENSIONS				QUANTITY PCS/REEL	
	K0	D	E	W	P	P0	P2	A	B	C	D	A	B	C	D	178	330
SDT0402	3.2	1.55	1.75	12	8	4	2	0.270	0.160	0.140	0.055	330	100	13	13.4	-	2500
								6.86	4.06	3.56	1.40	178	60		13.2	750	-
SDT0804	5.4	1.55	1.75	24	16	4	2	0.520	0.290	0.110	0.115	330	100	13	24.4	-	750
								13.21	7.37	2.79	2.92						



SDT SERIES RELIABILITY TEST

I-1 MECHANICAL PERFORMANCE

NO.	ITEM	SPECIFICATION	TEST CONDITIONS
I-1-1	Vibration	Appearance : No Damage L Change : within $\pm 10\%$ Q Change : within $\pm 30\%$ RDC : within Specification	Test device shall be soldered on the substrate. Oscillation Frequency : 10 to 55 to 10Hz for 1Min. Amplitude : 1.5mm Time : 2Hrs. for each Axis (X,Y & Z), Total 6Hrs.
I-1-2	Resistance to Soldering Heat	Appearance : No Damage	Pre-heating : 150°C, 1Min. Solder Composition : Sn/Pb = 63/37 Solder Temperature : 260 \pm 5°C Immersion Time : 10 \pm 1Sec.
I-1-3	Solderability	The electrodes shall be at least 90% covered with new solder coating.	Pre-heating : 150°C, 1Min. Solder Composition : Sn/Pb = 63/37 Solder Temperature : 230 \pm 5°C Immersion Time : 4 \pm 1Sec.

I-2 ENVIRONMENTAL PERFORMANCE

NO.	ITEM	SPECIFICATION	TEST CONDITIONS															
I-2-1	Temperature Shock	Appearance : No Damage L Change : within $\pm 10\%$ L Change : within $\pm 30\%$ RDC : within Specification	10 Cycles (Air to Air) Cycles shall Consist of : 30Min. Exposure to -55°C 30Min. Exposure to 125°C 15Sec. Max. Transition between Temperatures Measured after Exposure in the Room Condition for 24Hrs.															
I-2-2	Temperature Cycle		One Cycle <table border="1"> <thead> <tr> <th>Step</th> <th>Temperature (°C)</th> <th>Time (Min.)</th> </tr> </thead> <tbody> <tr> <td>1</td> <td>-25 \pm 3</td> <td>30</td> </tr> <tr> <td>2</td> <td>25 \pm 2</td> <td>3</td> </tr> <tr> <td>3</td> <td>85 \pm 3</td> <td>30</td> </tr> <tr> <td>4</td> <td>25 \pm 2</td> <td>3</td> </tr> </tbody> </table> Total : 100 Cycles Measured after Exposure in the Room Condition for 24Hrs.	Step	Temperature (°C)	Time (Min.)	1	-25 \pm 3	30	2	25 \pm 2	3	3	85 \pm 3	30	4	25 \pm 2	3
Step	Temperature (°C)	Time (Min.)																
1	-25 \pm 3	30																
2	25 \pm 2	3																
3	85 \pm 3	30																
4	25 \pm 2	3																
I-2-3	Humidity Resistance		Temperature : 40 \pm 2°C Relative Humidity : 90 ~ 95% Time : 1000Hrs. Measured after Exposure in the Room Condition for 24Hrs.															
I-2-4	High Temperature Resistance		Temperature : 85 \pm 3°C Relative Humidity : 20% Applied Current : Rated Current Time : 1000Hrs. Measured after Exposure in the Room Condition for 24Hrs.															
I-2-5	Low Temperature Resistance		Temperature : -25 \pm 3°C Relative Humidity : 0% Time : 1000Hrs. Measured after Exposure in the Room Condition for 24Hrs.															

SMD Power Inductors

SSL0618 Series



Description

- 2mm max height
- Inductance range from 1 μ H to 1000 μ H
- Current range from 2.3Amps to 0.08Amps
- Very competitive cost design.

PRODUCT IDENTIFICATION

SSL □□□□ □-□□□□-□

International No.
Tolerance
Inductance
Packaging Style
Dimensions
Product Symbol

Environmental Data

- Storage temperature range: -40°C to +125°C
- Operating ambient temperature range: -40°C to +85°C (range is application specific). Temperature rise is approximately 40°C at rated rms current
- Infrared reflow temperature : +240°C for 30 seconds.

SHAPES AND DIMENSIONS

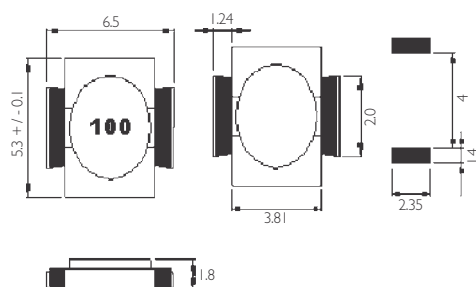

For SSL series provide excellent current carrying capabilities in a small footprint. They have a flat top for reliable pick and place operations and features robust temperature deflection. In addition to the standard versions shown here, custom inductors are available to meet your exact requirement.

Applications

- Digital cameras, CD players, cellular phones, and PDAs
- PCMCIA cards
- GPS systems

ELECTRICAL CHARACTERISTICS

PART NO.	INDUCTANCE (μ H \pm 20%)*	SRF (MHz)	DC RESISTANCE (Ω^{+0})	Isat ** (A)	Irms *** (A)
SSL0618T-1R0M-S	1.0	230	0.04	2.50	2.30
SSL0618T-1R5M-S	1.5	180	0.06	2.20	2.10
SSL0618T-2R2M-S	2.2	140	0.07	1.80	1.70
SSL0618T-3R3M-S	3.3	110	0.12	1.40	1.30
SSL0618T-4R7M-S	4.7	100	0.15	1.20	1.10
SSL0618T-6R8M-S	6.8	80	0.20	1.10	1.00
SSL0618T-100M-S	10	60	0.26	1.00	0.90
SSL0618T-150M-S	15	45	0.40	0.80	0.70
SSL0618T-220M-S	22	35	0.54	0.60	0.50
SSL0618T-330M-S	33	30	0.74	0.50	0.45
SSL0618T-470M-S	47	22	1.10	0.45	0.40
SSL0618T-680M-S	68	20	1.60	0.35	0.35
SSL0618T-101M-S	100	15	2.30	0.30	0.30
SSL0618T-151M-S	150	10	3.50	0.25	0.25
SSL0618T-221M-S	220	9	5.70	0.20	0.18
SSL0618T-331M-S	330	8	8.20	0.16	0.16
SSL0618T-471M-S	470	7	10.8	0.14	0.12
SSL0618T-681M-S	680	5	17.2	0.12	0.10
SSL0618T-102M-S	1000	4	22.6	0.08	0.08

* Inductance Tested at 100 KHz , 0.1 Vrms

** DC current at which the inductance drops 10% (typ) from its value without current.

*** Average current for a 40°C rise above 25°C ambient.

**** Operating Temperature Range -40°C to +85°C

***** Electrical specifications at 25°C

SMD Power Inductors

SSL0400 Series



Features

- High energy storage and very low resistance.
- Smallest size and high performance

PRODUCT IDENTIFICATION

SSL □□□□ □-□□□□-□

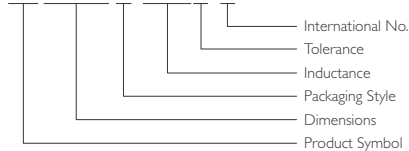

- Packaging: T : Tape and Reel
- Tolerance: M: $\pm 20\%$
- Note: YAGEO will start to release SSL Series inductors with lead-free terminals which meet SONY SS-00259's criteria for lead-free product in Q2 of 2004, and YAGEO Internal No will be changed to "N" as identification. Ex. SSL04LP-1R2M-N

SHAPES AND DIMENSIONS

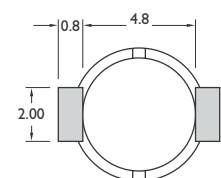
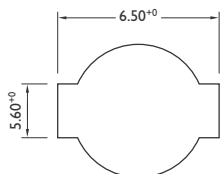

Dimensions : mm

This Series is designed for applications requiring high inductance, high current and an ultra-low profile.

The SSL0400T measures only 2 mm high and has a footprint of just 5.3 x 6.5mm. But despite this small size, it is available in versions that will handle up to 2.5 Amps. The series covers a wide range of inductance values from 1 μ H to 1mH.

The core is completely enclosed in a rugged ceramic case giving it a flat top that provides the optimum surface for reliable pick and place operations.

Applications

- Notebook computers, Sep-up and step-down converters
- Flash, memory programmers. etc...

ELECTRICAL CHARACTERISTICS

PART NO.	INDUCTANCE* (μ H)	TOLERANCE ($\pm\%$)	DC RESISTANCE (Ω) Max.	SRF (MHz) Ref.	I _{sat} ** (A)	I _{rms} *** (A)
SSL0400T-1R0M-S	1.0	20	0.05	230	2.5	2.3
SSL0400T-1R5M-S	1.5	20	0.06	180	2.2	2.1
SSL0400T-2R2M-S	2.2	20	0.07	140	1.8	1.7
SSL0400T-3R3M-S	3.3	20	0.12	110	1.4	1.3
SSL0400T-4R7M-S	4.7	20	0.15	100	1.2	1.1
SSL0400T-6R8M-S	6.8	20	0.20	80	1.1	1.0
SSL0400T-100M-S	10	20	0.30	60	1.0	0.90
SSL0400T-150M-S	15	20	0.40	45	0.8	0.70
SSL0400T-220M-S	22	20	0.54	35	0.6	0.50
SSL0400T-330M-S	33	20	0.74	30	0.5	0.45
SSL0400T-470M-S	47	20	1.1	22	0.45	0.40
SSL0400T-680M-S	68	20	1.6	20	0.35	0.35
SSL0400T-101M-S	100	20	2.3	15	0.30	0.30
SSL0400T-151M-S	150	20	3.5	10	0.25	0.25
SSL0400T-221M-S	220	20	5.7	9	0.2	0.18
SSL0400T-331M-S	330	20	8.2	8	0.16	0.16
SSL0400T-471M-S	470	20	10.8	7	0.14	0.12
SSL0400T-681M-S	680	20	17.2	5	0.12	0.10
SSL0400T-102M-S	1000	20	22.6	4	0.08	0.08

* Inductance Tested at 100 KHz, 0.1 Vrms.

** Inductance Drop = 10% Typ. at Isat

*** $\Delta T = 30^\circ\text{C}$ Rise Typ at I_{rms}Operating Temperature Range -40°C to $+85^\circ\text{C}$



TAPE DIMENSIONS

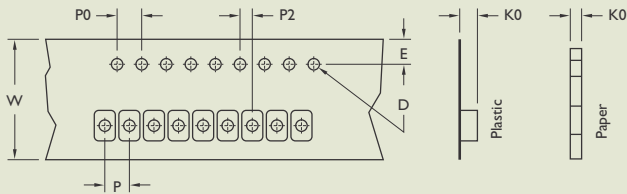

TAPE MATERIAL

Carrier Tape : Polystyrene

Cover Type : Polyethylene

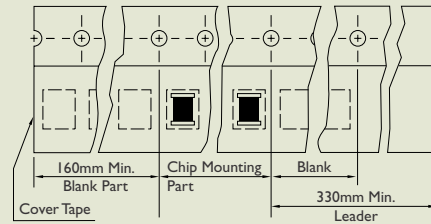

REEL DIMENSIONS

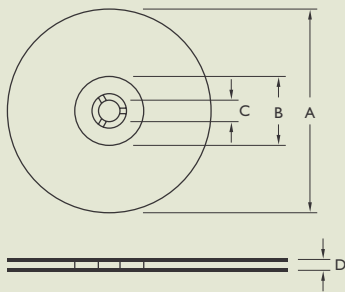

RECOMMENDED PATTERN

Land Pattern

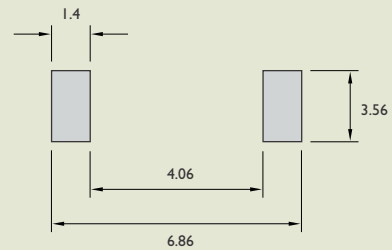

Dimensions : mm

TYPE	TAPE DIMENSIONS							REEL DIMENSIONS				QUANTITY (PCS/REEL)	
	K0	D	E	W	P	P0	P2	A	B	C	D	178mm	330mm
SSL0400	1.85	1.5	1.75	12	8	4	2	330	100	13	13.4	-	3500
								178	60		13.2	1000	-

SMD Unshielded Power Inductors

SSL04LP Series

DC-DC Conversion



Features

- High energy storage and very low resistance.
- Smallest size and high performance

PRODUCT IDENTIFICATION

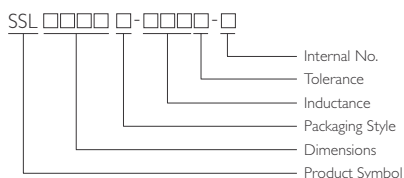

- Packaging: T : Tape and Reel, B : Bulk
- Tolerance: M: $\pm 20\%$
- Note: YAGEO will start to release SSL Series inductors with lead-free terminals which meet SONY SS-00259's criteria for lead-free product in Q2 of 2004, and YAGEO Internal No will be changed to "N" as identification. Ex. SSL04LP-1R2M-N

SHAPES AND DIMENSIONS

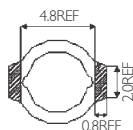
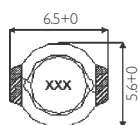

Dimensions : mm

For SSL series provide excellent current carrying capabilities in a small footprint. They have a flat top for reliable pick and place operations and features robust temperature deflection. In addition to the standard versions shown here, custom inductors are available to meet your exact requirement.

Applications

- Notebook computers, Sep-up and step-down converters
- Flash, memory programmers, etc...

ELECTRICAL CHARACTERISTICS

PART NO.	INDUCTANCE (μH) *	TOLERANCE ($\pm\%$)	DC RESISTANCE (Ω^{+0})max	Isat ** (A)	Irms *** (A)
SSL04LP-1R2M-S	1.2	20	0.08	2.10	1.70
SSL04LP-1R5M-S	1.5	20	0.10	1.90	1.50
SSL04LP-2R2M-S	2.2	20	0.12	1.60	1.40
SSL04LP-3R3M-S	3.3	20	0.16	1.30	1.20
SSL04LP-4R7M-S	4.7	20	0.20	1.10	1.10
SSL04LP-6R8M-S	6.8	20	0.32	0.90	0.85
SSL04LP-100M-S	10	20	0.41	0.80	0.75
SSL04LP-150M-S	15	20	0.55	0.65	0.60
SSL04LP-220M-S	22	20	0.85	0.50	0.52
SSL04LP-330M-S	33	20	1.30	0.40	0.42
SSL04LP-470M-S	47	20	1.80	0.35	0.36
SSL04LP-680M-S	68	20	2.50	0.30	0.30
SSL04LP-101M-S	100	20	3.50	0.25	0.26
SSL04LP-151M-S	150	20	5.00	0.18	0.21
SSL04LP-221M-S	220	20	7.00	0.16	0.18
SSL04LP-331M-S	330	20	15.0	0.13	0.13

* Inductance Tested at 100 KHz , 0.1 Vrms

** Inductance drops =10% typ. at Isat.

*** $\Delta T=30^{\circ}\text{C}$ rise typ at Irms

**** Operating Temperature Range -40°C to $+85^{\circ}\text{C}$



TAPE DIMENSIONS

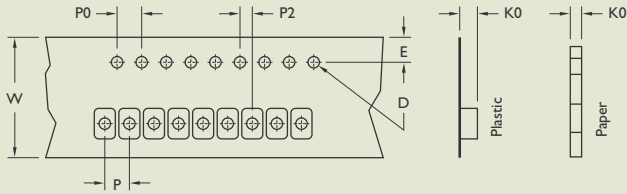

TAPE MATERIAL

Carrier Tape : Polystyrene

Cover Type : Polyethylene

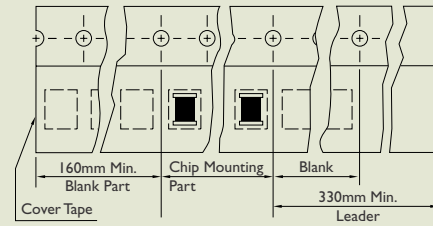

REEL DIMENSIONS

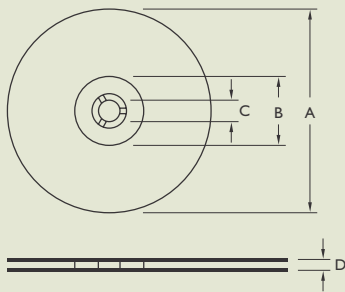

RECOMMENDED PATTERN

Land Pattern

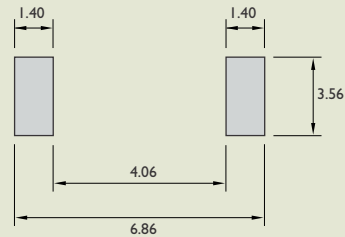

Dimensions : mm

TYPE	TAPE DIMENSIONS							REEL DIMENSIONS				QUANTITY (PCS/REEL)	
	K0	D	E	W	P	P0	P2	A	B	C	D	178	330
SSL04LP	1.30	1.5	1.75	12	8	4	2	330	100	13	13.4	-	3500
								178	60	13	13.2	1000	-

SMD Power Inductors

SSL040I Series



Features

- High energy storage and very low resistance.
- Smallest size and high performance

PRODUCT IDENTIFICATION

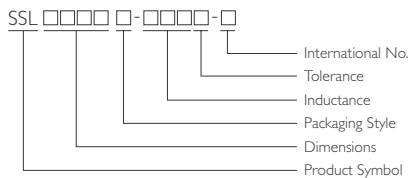

- Packaging: T : Tape and Reel
- Tolerance: M: $\pm 20\%$
- Note: YAGEO will start to release SSL Series inductors with lead-free terminals which meet SONY SS-00259's criteria for lead-free product in Q2 of 2004, and YAGEO Internal No will be changed to "N" as identification. Ex. SSL04LP-1R2M-N

SHAPES AND DIMENSIONS

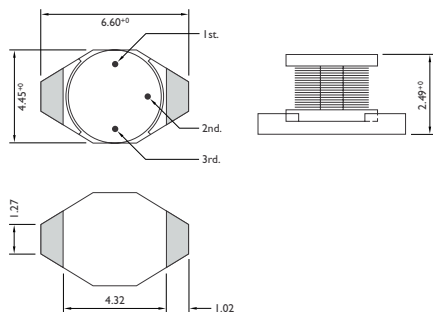

Dimensions : mm

For SSL series provide excellent current carrying capabilities in a small footprint. They have a flat top for reliable pick and place operations and features robust temperature deflection. In addition to the standard versions shown here, custom inductors are available to meet your exact requirement.

Applications

- Notebook computers, Sep-up and step-down converters
- Flash, memory programmers. etc...

ELECTRICAL CHARACTERISTICS

PART NO.	INDUCTANCE ($\mu\text{H} \pm 20\%$) *	SRF (MHz)	DC RESISTANCE (Ω^{+0})	Isat ** (A)	Irms *** (A)
SSL040IT-1R0M-S	1.0	180	0.090	2.3	2.7
SSL040IT-1R5M-S	1.5	140	0.090	2.1	2.5
SSL040IT-2R2M-S	2.2	125	0.100	1.8	2.1
SSL040IT-3R3M-S	3.3	100	0.120	1.6	1.9
SSL040IT-4R7M-S	4.7	80	0.130	1.2	1.8
SSL040IT-6R8M-S	6.8	60	0.165	0.96	1.6
SSL040IT-100M-S	10	50	0.190	0.88	1.5
SSL040IT-150M-S	15	40	0.320	0.72	1.1
SSL040IT-220M-S	22	30	0.540	0.56	1.0
SSL040IT-330M-S	33	20	0.740	0.46	0.9

* Inductance Tested at 0.1 Vrms, 100 KHz

** Inductance Drop = 10% Typ. at Isat.

*** $\Delta T = 30^\circ\text{C}$ Rise Typ at I rms.Operating Temperature Range -40°C to $+85^\circ\text{C}$

SSL0402 Series

SMD Power Inductors

For SSL series provide excellent current carrying capabilities in a small footprint. They have a flat top for reliable pick and place operations and features robust temperature deflection. In addition to the standard versions shown here, custom inductors are available to meet your exact requirement.

Applications

- Notebook computers, Sep-up and step-down converters
- Flash, memory programmers. Etc...

ELECTRICAL CHARACTERISTICS

PART NO.	INDUCTANCE ($\mu\text{H} \pm 20\%$) *	SRF (MHz)	DC RESISTANCE (Ω^{+0})	Isat ** (A)	Irms *** (A)
SSL0402T-1R0M-S	1.0	130	0.05	2.90	2.9
SSL0402T-1R5M-S	1.5	115	0.05	2.60	2.8
SSL0402T-2R2M-S	2.2	90	0.07	2.30	2.4
SSL0402T-3R3M-S	3.3	70	0.08	2.00	2.0
SSL0402T-4R7M-S	4.7	50	0.09	1.50	1.5
SSL0402T-6R8M-S	6.8	45	0.13	1.20	1.4
SSL0402T-100M-S	10	35	0.16	1.10	1.1
SSL0402T-150M-S	15	30	0.23	0.90	1.2
SSL0402T-220M-S	22	20	0.37	0.70	0.8
SSL0402T-330M-S	33	15	0.51	0.58	0.6
SSL0402T-470M-S	47	14	0.64	0.50	0.5
SSL0402T-680M-S	68	11	0.86	0.40	0.4
SSL0402T-101M-S	100	9	1.27	0.31	0.3
SSL0402T-151M-S	150	6	2.00	0.27	0.25
SSL0402T-221M-S	220	5.5	3.11	0.22	0.20
SSL0402T-331M-S	330	5	3.80	0.18	0.16
SSL0402T-471M-S	470	4	5.06	0.16	0.15
SSL0402T-681M-S	680	3	9.20	0.14	0.12
SSL0401T-102M-S	1000	2	13.8	0.10	0.07

* Inductance Tested at 0.1 Vrms, 100 KHz

** Inductance Drop = 10% Typ. at Isat.

*** $\Delta T = 30^\circ\text{C}$ Rise Typ at I rms.

Operating Temperature Range -40°C to $+85^\circ\text{C}$



Features

- High energy storage and very low resistance.
- Smallest size and high performance

PRODUCT IDENTIFICATION

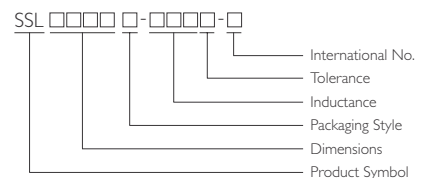

- Packaging: T : Tape and Reel
- Tolerance: M: $\pm 20\%$
- Note: YAGEO will start to release SSL Series inductors with lead-free terminals which meet SONY SS-00259's criteria for lead-free product in Q2 of 2004, and YAGEO Internal No will be changed to "N" as identification. Ex. SSL04LP-1R2M-N

SHAPES AND DIMENSIONS

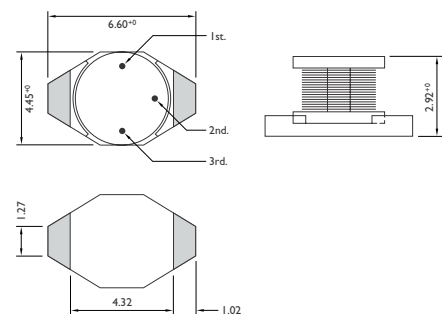

Dimensions : mm

SMD Power Inductors

SSL0802 Series



Features

- High energy storage and very low resistance.
- Smallest size and high performance

PRODUCT IDENTIFICATION

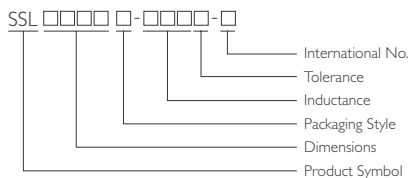

- Packaging: T : Tape and Reel
- Tolerance: M: $\pm 20\%$
- Note: YAGEO will start to release SSL Series inductors with lead-free terminals which meet SONY SS-00259's criteria for lead-free product in Q2 of 2004, and YAGEO Internal No will be changed to "N" as identification. Ex. SSL04LP-1R2M-N

SHAPES AND DIMENSIONS

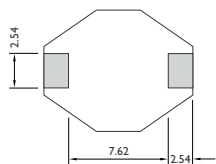
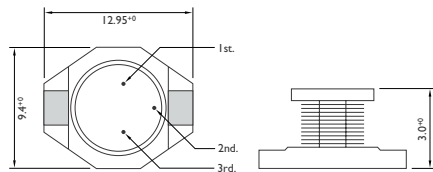

Dimensions : mm

For SSL series provide excellent current carrying capabilities in a small footprint. They have a flat top for reliable pick and place operations and features robust temperature deflection. In addition to the standard versions shown here, custom inductors are available to meet your exact requirement.

Applications

- Notebook computers, Sep-up and step-down converters
- Flash, memory programmers. Etc...

ELECTRICAL CHARACTERISTICS

PART NO.	INDUCTANCE ($\mu\text{H} \pm 20\%$) *	SRF (MHz)	DC RESISTANCE (Ω^{+0})	Isat ** (A)	I _{rms} *** (A)
SSL0802T-100M-S	10	35	0.09	2.4	2.0
SSL0802T-150M-S	15	33	0.12	2.0	1.5
SSL0802T-220M-S	22	25	0.19	1.6	1.3
SSL0802T-330M-S	33	19	0.25	1.4	1.1
SSL0802T-470M-S	47	14	0.32	1.0	0.8
SSL0802T-680M-S	68	12	0.55	0.9	0.7
SSL0802T-101M-S	100	10	0.7	0.7	0.6
SSL0802T-151M-S	150	8	1.0	0.6	0.5
SSL0802T-221M-S	220	6	1.6	0.5	0.4
SSL0802T-331M-S	330	5	2.2	0.4	0.3
SSL0802T-471M-S	470	4	3.3	0.3	0.2
SSL0802T-681M-S	680	3	4.4	0.2	0.1
SSL0802T-102M-S	1000	2.5	7.0	0.1	0.05

* Inductance Tested at 0.1 Vrms, 100 KHz

** Inductance Drop = 10% Typ. at Isat.

*** $\Delta T = 30^\circ\text{C}$ Rise Typ at I_{rms}.Operating Temperature Range -40°C to $+85^\circ\text{C}$

SSL0804 Series

SMD Power Inductors

For SSL series provide excellent current carrying capabilities in a small footprint. They have a flat top for reliable pick and place operations and features robust temperature deflection. In addition to the standard versions shown here, custom inductors are available to meet your exact requirement.

Applications

- Notebook computers, Sep-up and step-down converters
- Flash, memory programmers. Etc...

ELECTRICAL CHARACTERISTICS

PART NO.	INDUCTANCE ($\mu\text{H} \pm 20\%$) *	SRF (MHz)	DC RESISTANCE (Ω^{+0}) $\pm 15\%$	Isat ** (A)	Irms *** (A)
SSL0804T-1R0M-S	1.0	100	0.009	9.0	6.8
SSL0804T-1R5M-S	1.5	90	0.010	8.0	6.4
SSL0804T-2R2M-S	2.2	80	0.012	7.0	6.1
SSL0804T-3R3M-S	3.3	65	0.015	6.4	5.4
SSL0804T-4R7M-S	4.7	45	0.018	5.4	4.8
SSL0804T-6R8M-S	6.8	38	0.027	4.6	4.4
SSL0804T-100M-S	10	30	0.038	3.8	3.9
SSL0804T-150M-S	15	27	0.046	3.0	3.1
SSL0804T-220M-S	22	19	0.085	2.6	2.7
SSL0804T-330M-S	33	15	0.10	2.0	2.1
SSL0804T-470M-S	47	12	0.14	1.6	1.8
SSL0804T-680M-S	68	10	0.20	1.4	1.5
SSL0804T-101M-S	100	9	0.28	1.2	1.3
SSL0804T-151M-S	150	6	0.40	1.0	1.0
SSL0804T-221M-S	220	5	0.61	0.8	0.8
SSL0804T-331M-S	330	4.5	1.02	0.6	0.6
SSL0804T-471M-S	470	3.5	1.27	0.5	0.5
SSL0804T-681M-S	680	2.5	2.02	0.4	0.4
SSL0804T-102M-S	1000	2.0	3.0	0.3	0.3

* Inductance Tested at 0.1 Vrms, 100 KHz

** Inductance Drop = 10% Typ. at Isat.

*** $\Delta T = 15^\circ\text{C}$ Rise Typ at Irms.

Operating Temperature Range -40°C to $+85^\circ\text{C}$



Features

- High energy storage and very low resistance.
- Smallest size and high performance

PRODUCT IDENTIFICATION

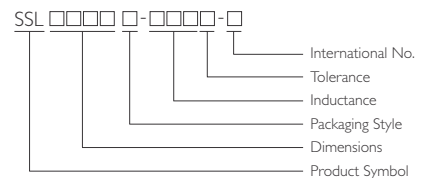

- Packaging: T : Tape and Reel
- Tolerance: M: $\pm 20\%$
- Note: YAGEO will start to release SSL Series inductors with lead-free terminals which meet SONY SS-00259's criteria for lead-free product in Q2 of 2004, and YAGEO Internal No will be changed to "N" as identification. Ex: SSL04LP-1R2M-N

SHAPES AND DIMENSIONS

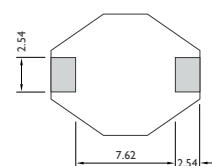
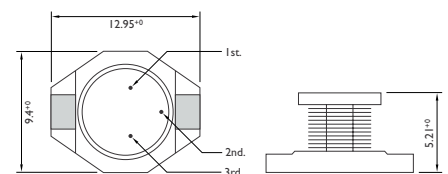

Dimensions : mm

SMD Power Inductors

SSL0810 Series



Features

- High energy storage and very low resistance.
- Smallest size and high performance

PRODUCT IDENTIFICATION

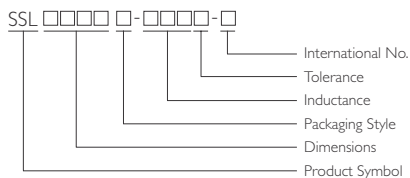

- Packaging: T : Tape and Reel
- Tolerance: M: $\pm 20\%$
- Note: YAGEO will start to release SSL Series inductors with lead-free terminals which meet SONY SS-00259's criteria for lead-free product in Q2 of 2004, and YAGEO Internal No will be changed to "IN" as identification. Ex. SSL04LP-IR2M-N

SHAPES AND DIMENSIONS

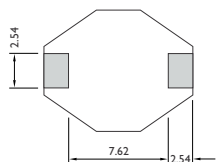
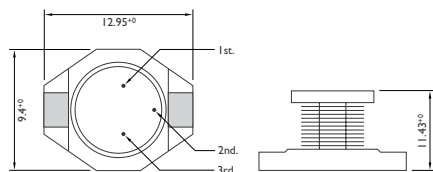

Dimensions : mm

For SSL series provide excellent current carrying capabilities in a small footprint. They have a flat top for reliable pick and place operations and features robust temperature deflection. In addition to the standard versions shown here, custom inductors are available to meet your exact requirement.

Applications

- Notebook computers, Sep-up and step-down converters
- Flash, memory programmers. Etc...

ELECTRICAL CHARACTERISTICS

PART NO.	INDUCTANCE ($\mu\text{H} \pm 20\%$) *	SRF (MHz)	DC RESISTANCE (Ω^{+0})	Isat ** (A)	I _{rms} *** (A)
SSL0810T-100M-S	10	22	0.04	8.0	3.5
SSL0810T-150M-S	15	18	0.05	7.0	3.0
SSL0810T-220M-S	22	11	0.07	5.5	2.5
SSL0810T-330M-S	33	9	0.08	4.0	2.0
SSL0810T-470M-S	47	8	0.11	3.8	1.6
SSL0810T-680M-S	68	7	0.17	3.0	1.2
SSL0810T-101M-S	100	5	0.22	2.5	1.2
SSL0810T-151M-S	150	4	0.34	2.0	0.9
SSL0810T-221M-S	220	3.5	0.44	1.6	0.7
SSL0810T-331M-S	330	2.5	0.70	1.2	0.6
SSL0810T-471M-S	470	2	0.95	1.0	0.3
SSL0810T-681M-S	680	2	1.2	1.0	0.2
SSL0810T-102M-S	1000	1.5	2.0	0.8	0.1

* Inductance Tested at 0.1 Vrms, 100 KHz

** Inductance Drop = 10% Typ. at Isat.

*** $\Delta T = 40^\circ\text{C}$ Rise Typ at I_{rms}.Operating Temperature Range -40°C to $+85^\circ\text{C}$

SSL I 306 Series

SMD Power Inductors

For SSL series provide excellent current carrying capabilities in a small footprint. They have a flat top for reliable pick and place operations and features robust temperature deflection. In addition to the standard versions shown here, custom inductors are available to meet your exact requirement.

Applications

- Notebook computers, Sep-up and step-down converters
- Flash, memory programmers. Etc...

ELECTRICAL CHARACTERISTICS

PART NO.	INDUCTANCE ($\mu\text{H} \pm 20\%$) *	SRF (MHz)	DC RESISTANCE (Ω^{+0})	Isat ** (A)	Irms *** (A)
SSL I 306T-1R0M-S	1.0	80	0.011	20	8.6
SSL I 306T-2R2M-S	2.2	80	0.014	16	7.1
SSL I 306T-3R3M-S	3.3	60	0.016	14	6.2
SSL I 306T-5R6M-S	5.6	40	0.022	12	5.3
SSL I 306T-100M-S	10	30	0.032	10	4.3
SSL I 306T-150M-S	15	22	0.036	8.0	4.0
SSL I 306T-220M-S	22	20	0.047	7.0	3.5
SSL I 306T-330M-S	33	15	0.066	5.5	3.0
SSL I 306T-470M-S	47	9	0.087	4.5	2.6
SSL I 306T-680M-S	68	8	0.13	3.5	2.3
SSL I 306T-101M-S	100	7	0.19	3.0	1.8
SSL I 306T-151M-S	150	6	0.25	2.6	1.5
SSL I 306T-221M-S	220	5	0.38	2.4	1.2
SSL I 306T-331M-S	330	4	0.56	1.9	1.0
SSL I 306T-471M-S	470	3	0.85	1.4	0.82
SSL I 306T-681M-S	680	2.5	1.2	1.2	0.72
SSL I 306T-102M-S	1000	2	1.8	1.0	0.56

* Inductance Tested at 0.1 Vrms, 100 KHz

** Inductance Drop = 10% Typ. at Isat.

*** $\Delta T = 40^\circ\text{C}$ Rise Typ. at Irms.

Operating Temperature Range -40°C to $+85^\circ\text{C}$



Features

- High energy storage and very low resistance.
- Smallest size and high performance

PRODUCT IDENTIFICATION

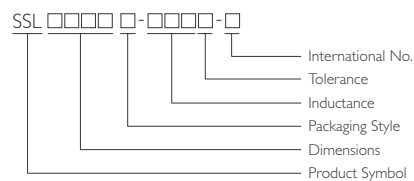

- Packaging: T : Tape and Reel
- Tolerance: M: $\pm 20\%$
- Note: YAGEO will start to release SSL Series inductors with lead-free terminals which meet SONY SS-00259's criteria for lead-free product in Q2 of 2004, and YAGEO Internal No will be changed to "N" as identification. Ex. SSL04LP-1R2M-N

SHAPES AND DIMENSIONS

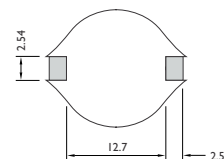
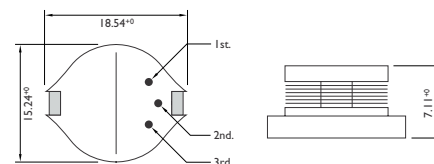

Dimensions : mm



TAPE DIMENSIONS

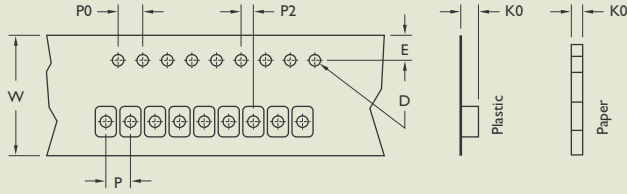

TAPE MATERIAL

Carrier Tape : Polystyrene

Cover Type : Polyethylene

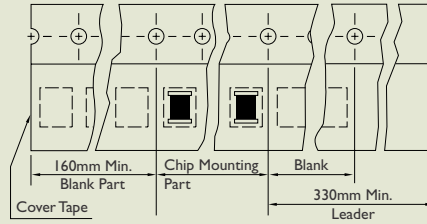

REEL DIMENSIONS

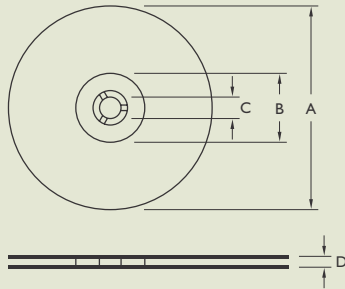

RECOMMENDED PATTERN

Land Pattern

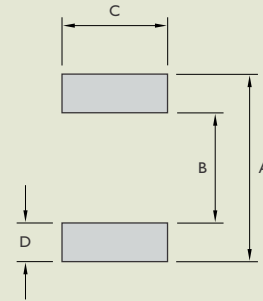

Dimensions : mm

TYPE	TAPE DIMENSIONS								RECOMMENDED PATTERN				REEL DIMENSIONS				QUANTITY /REEL	
	K0	D	E	W	P	P0	P2	A	B	C	D	A	B	C	D	178	330	
SSL0401	2.65	1.55	1.75	12	8	4	2	0.270	0.160	0.140	0.055	330	100	13	13.4	–	2500	
								6.86	4.06	3.56	1.40	178	60		13.2	750	–	
SSL0402	3.2	1.55	1.75	12	8	4	2	0.270	0.160	0.140	0.055	330	100	13	13.4	–	2500	
								6.86	4.06	3.58	1.40	178	60		13.2	750	–	
SSL0802	3.75	1.55	1.75	24	16	4	2	13.21	7.37	2.79	2.92	330	100	13	24.4	–	1000	
SSL0804	5.4	1.55	1.75	24	16	4	2	13.21	7.37	2.79	2.92	330	100	13	24.4	–	750	
SSL0810	11.5	1.55	1.75	24	20	4	2	13.21	7.37	2.79	2.92	330	100	13	24.4	–	225	
SSL1306	7.5	1.55	1.75	32	20	4	2	13.21	7.37	2.79	2.92	330	100	13	33.4	–	250	



SSL SERIES RELIABILITY TEST

I-1 MECHANICAL PERFORMANCE

NO.	ITEM	SPECIFICATION	TEST CONDITIONS
I-1-1	Vibration	Appearance : No Damage L Change : within $\pm 10\%$ Q Change : within $\pm 30\%$ RDC : within Specification	Test device shall be soldered on the substrate. Oscillation Frequency : 10 to 55 to 10Hz for 1Min. Amplitude : 1.5mm Time : 2Hrs. for each Axis (X,Y & Z), Total 6Hrs.
I-1-2	Resistance to Soldering Heat	Appearance : No Damage	Pre-heating : 150°C, 1Min. Solder Composition : Sn/Pb = 63/37 Solder Temperature : 260 \pm 5°C Immersion Time : 10 \pm 1Sec.
I-1-3	Solderability	The electrodes shall be at least 90% covered with new solder coating.	Pre-heating : 150°C, 1Min. Solder Composition : Sn/Pb = 63/37 Solder Temperature : 230 \pm 5°C Immersion Time : 4 \pm 1Sec.

I-2 ENVIRONMENTAL PERFORMANCE

NO.	ITEM	SPECIFICATION	TEST CONDITIONS															
I-2-1	Temperature Shock	Appearance : No Damage L Change : within $\pm 10\%$ L Change : within $\pm 30\%$ RDC : within Specification	10 Cycles (Air to Air) Cycles shall Consist of : 30Min. Exposure to -55°C 30Min. Exposure to 125°C 15Sec. Max. Transition between Temperatures Measured after Exposure in the Room Condition for 24Hrs.															
I-2-2	Temperature Cycle		One Cycle <table border="1"> <thead> <tr> <th>Step</th> <th>Temperature (°C)</th> <th>Time (Min.)</th> </tr> </thead> <tbody> <tr> <td>1</td> <td>-25 \pm 3</td> <td>30</td> </tr> <tr> <td>2</td> <td>25 \pm 2</td> <td>3</td> </tr> <tr> <td>3</td> <td>85 \pm 3</td> <td>30</td> </tr> <tr> <td>4</td> <td>25 \pm 2</td> <td>3</td> </tr> </tbody> </table>	Step	Temperature (°C)	Time (Min.)	1	-25 \pm 3	30	2	25 \pm 2	3	3	85 \pm 3	30	4	25 \pm 2	3
Step	Temperature (°C)	Time (Min.)																
1	-25 \pm 3	30																
2	25 \pm 2	3																
3	85 \pm 3	30																
4	25 \pm 2	3																
I-2-3	Humidity Resistance		Total : 100 Cycles Measured after Exposure in the Room Condition for 24Hrs. Temperature : 40 \pm 2°C Relative Humidity : 90 ~ 95% Time : 1000Hrs. Measured after Exposure in the Room Condition for 24Hrs.															
I-2-4	High Temperature Resistance		Temperature : 85 \pm 3°C Relative Humidity : 20% Applied Current : Rated Current Time : 1000Hrs. Measured after Exposure in the Room Condition for 24Hrs.															
I-2-5	Low Temperature Resistance		Temperature : -25 \pm 3°C Relative Humidity : 0% Time : 1000Hrs. Measured after Exposure in the Room Condition for 24Hrs.															



TYPICAL ELECTRICAL CHARACTERISTICS

Curves of SSL Series

Test Instruments :

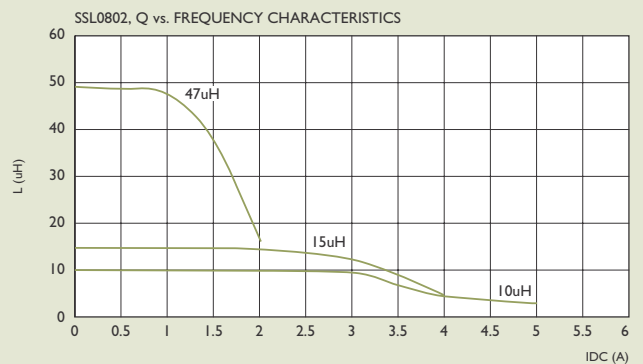
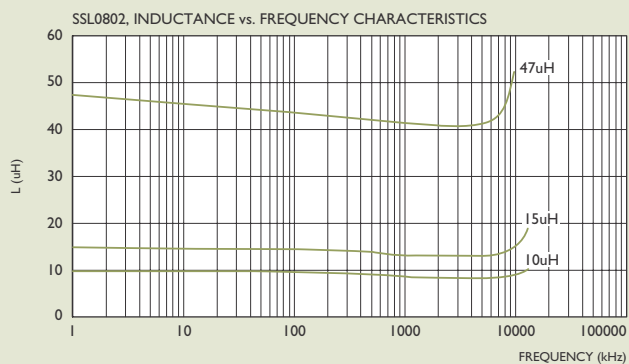
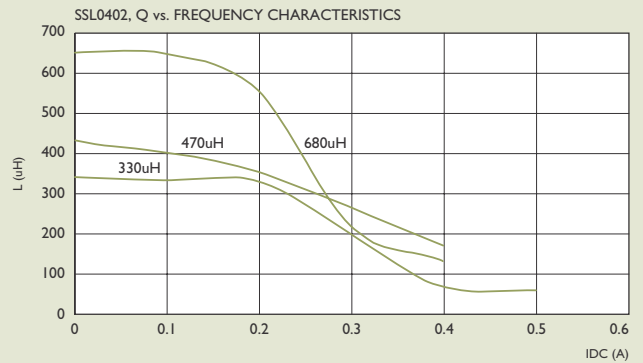
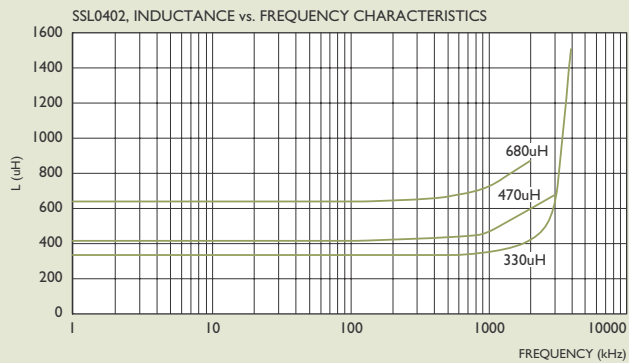
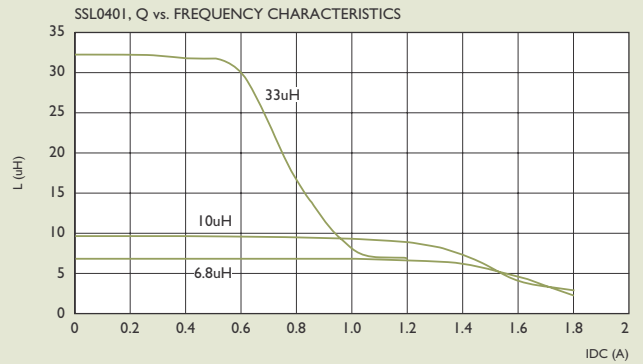
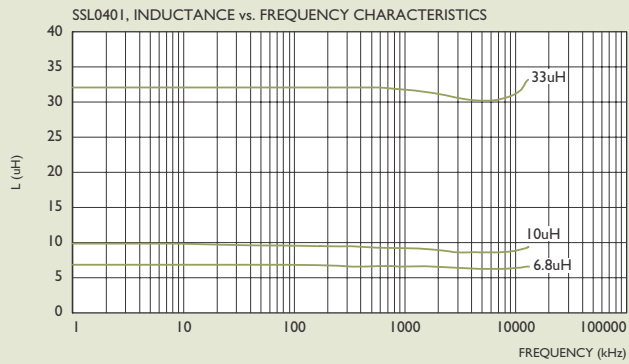
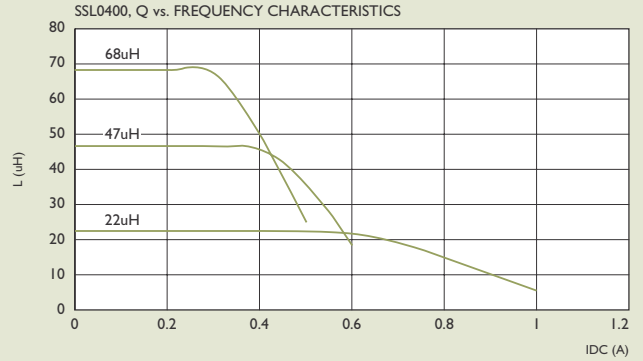
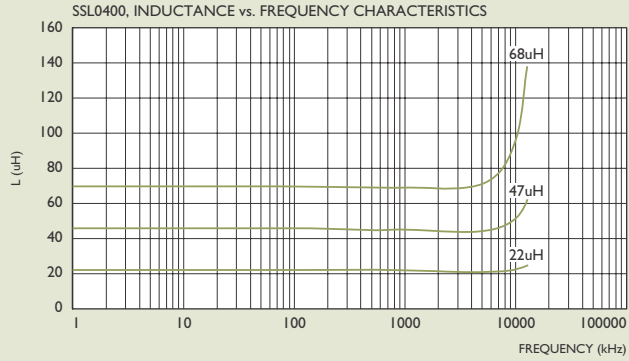



TYPICAL ELECTRICAL CHARACTERISTICS

Curves of SSL Series

Test Instruments :

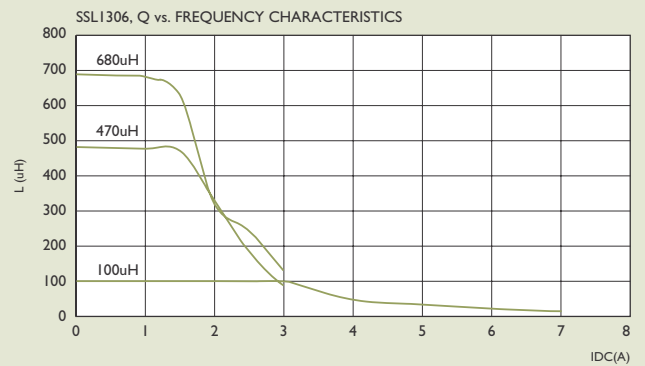
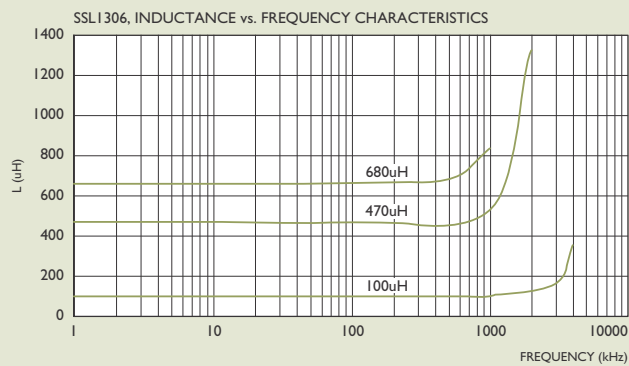
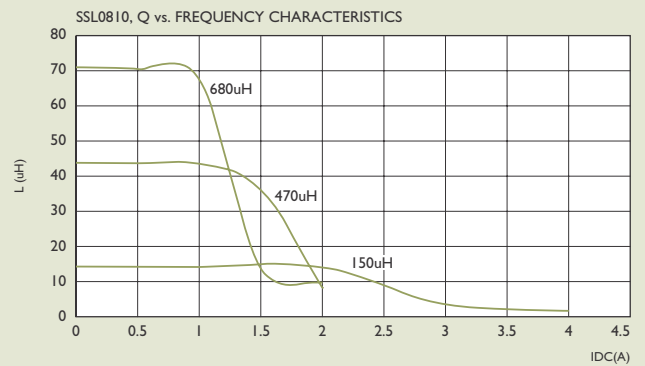
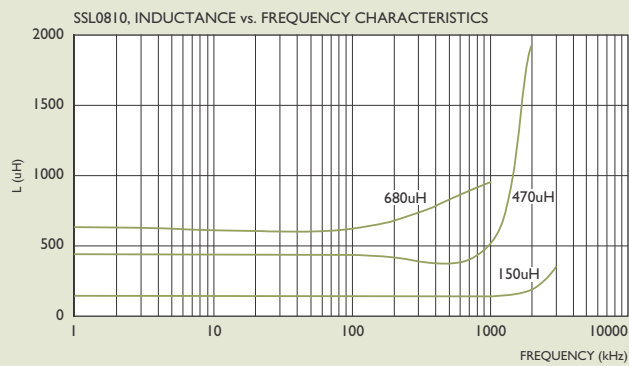
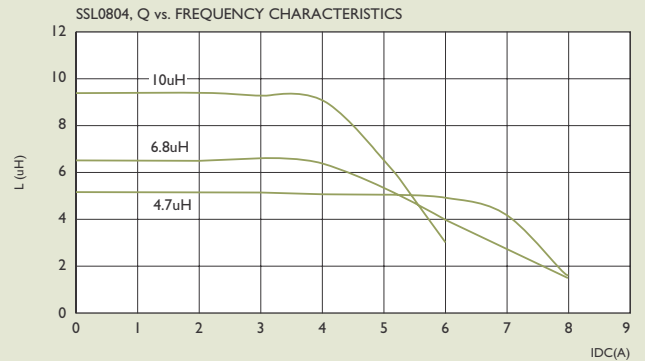
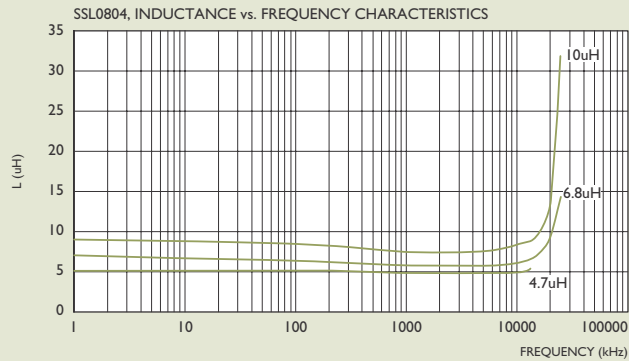

SMD Power Inductors

SSL0503HC Series



Features

- For high current, low voltage DC-DC converter applications.

PRODUCT IDENTIFICATION

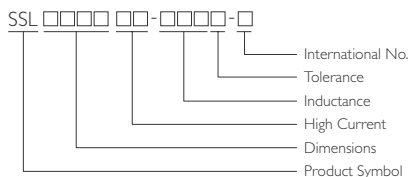

- Packaging: T: Tape and Reel, B : Bulk
- Tolerance: M: $\pm 20\%$
- Note: YAGEO will start to release SSL_HC Series inductors with lead-free terminals which meet SONY SS-00259's criteria for lead-free product in Q2 of 2004, and YAGEO Internal No will be changed to "N" as identification. Ex. SSL0503HC-R56M-N

SHAPES AND DIMENSIONS

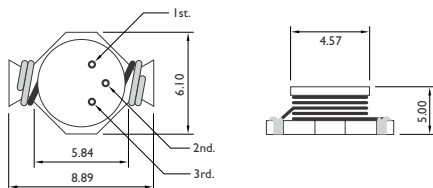

Dimensions : mm

These series have been specially designed for high current, low voltage DC-DC converter applications.

This simple, rugged design provides current ratings normally available only in much larger packages – up to 16Arms for a .33 μ H part. With its tinned self-leaded construction, the SSL0804HC achieves very low DCR values and excellent solderability. In addition to the standard parts shown, custom values are also available.

These inductors are less than .2" (5mm) high. They have very low resistance and a rugged self-leaded construction.

Applications

- Notebook computers, Sep-up and step-down converters, memory programmers. etc...

ELECTRICAL CHARACTERISTICS

PART NO.	INDUCTANCE (μ H $\pm 20\%$) *	SRF ** (MHz)	DC RESISTANCE (Ω) Max.	Isat *** (A)	Irms **** (A)
SSL0503HC-R56M-S	0.56	200	0.010	7.7	6.0
SSL0503HC-1R2M-S	1.2	140	0.017	5.3	4.4
SSL0503HC-2R2M-S	2.2	100	0.035	3.5	3.1
SSL0503HC-4R7M-S	4.7	50	0.054	2.6	2.2
SSL0503HC-100M-S	10	40	0.111	1.9	1.5
SSL0503HC-150M-S	15	30	0.17	1.5	1.2
SSL0503HC-220M-S	22	25	0.25	1.2	1.0
SSL0503HC-330M-S	33	20	0.37	0.99	0.82
SSL0503HC-470M-S	47	15	0.47	0.87	0.72

* Inductance Tested at 0.25 Vrms, 100 KHz

** SRF measured using HP8753D network analyzer.

*** Inductance Drop = 30% Typ. at Isat.

**** $\Delta T = 40^\circ\text{C}$ Typ at I rms.

Operating Temperature Range -40°C to $+85^\circ\text{C}$

Electrical Specifications at 25°C

SSL0804HC Series

SMD Power Inductors

These series have been specially designed for high current, low voltage DC-DC converter applications.

This simple, rugged design provides current ratings normally available only in much larger packages – up to 16Arms for a .33 μ H part. With its tinned self-leaded construction, the SSL0804HC achieves very low DCR values and excellent solderability. In addition to the standard parts shown, custom values are also available.

These inductors are less than .2" (5mm) high. They have very low resistance and a rugged self-leaded construction.

Applications

- Notebook computers, Sep-up and step-down converters, memory programmers. etc...

ELECTRICAL CHARACTERISTICS

PART NO.	INDUCTANCE (μ H \pm 20%) *	SRF ** (MHz)	DC RESISTANCE (Ω) Max.	Isat *** (A)	Irms **** (A)
SSL0804HC-R33M-S	0.33	300	0.002	20	16
SSL0804HC-R68M-S	0.68	200	0.005	13	12
SSL0804HC-1R0M-S	1.0	100	0.006	11	10
SSL0804HC-1R5M-S	1.5	90	0.008	9.0	9
SSL0804HC-2R2M-S	2.2	90	0.011	7.8	7.4
SSL0804HC-2R7M-S	2.7	65	0.012	7.0	6.6
SSL0804HC-3R3M-S	3.3	65	0.014	6.4	5.9
SSL0804HC-4R7M-S	4.7	45	0.018	5.4	4.8
SSL0804HC-6R8M-S	6.8	35	0.035	3.6	5.0
SSL0804HC-100M-S	10	26	0.04	3.3	4.3
SSL0804HC-150M-S	15	21	0.06	2.4	3.5
SSL0804HC-220M-S	22	17	0.08	2.0	2.8
SSL0804HC-330M-S	33	14	0.15	1.7	2.1
SSL0804HC-470M-S	47	12	0.28	1.4	1.7
SSL0804HC-680M-S	68	9	0.3	1.2	1.5
SSL0804HC-101M-S	100	7	0.4	0.95	1.2

* Inductance Tested at 0.1 Vrms, 100 KHz

** SRF measured using HP8753D network analyzer:

*** Inductance Drop = 10% Typ. at Isat.

**** Δ T = 40°C Typ at I rms.

Operating Temperature Range -40°C to +85°C

Electrical Specifications at 25°C



Features

- For high current, low voltage DC-DC converter applications.

PRODUCT IDENTIFICATION

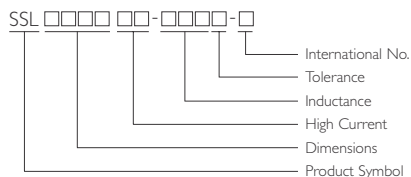

- Packaging: T: Tape and Reel, B: Bulk
- Tolerance: M: \pm 20%
- Note: YAGEO will start to release SSL_HC Series inductors with lead-free terminals which meet SONY SS-00259's criteria for lead-free product in Q2 of 2004, and YAGEO Internal No will be changed to "N" as identification. Ex. SSL0503HC-R56M-N

SHAPES AND DIMENSIONS

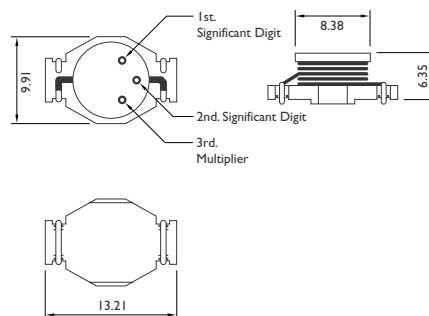

SMD Power Inductors

SSLI306HC Series



Features

- For high current, low voltage DC-DC converter applications.

PRODUCT IDENTIFICATION

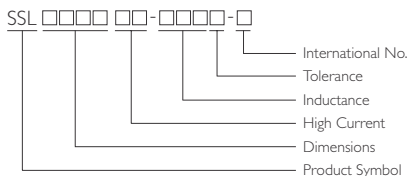

- Packaging: T: Tape and Reel, B: Bulk
- Tolerance: M: $\pm 20\%$
- Note: YAGEO will start to release SSL_HC Series inductors with lead-free terminals which meet SONY SS-00259's criteria for lead-free product in Q2 of 2004, and YAGEO Internal No will be changed to "N" as identification. Ex. SSL0503HC-R56M-N

SHAPES AND DIMENSIONS

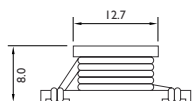
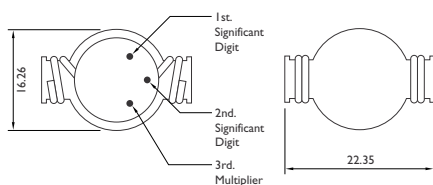

Dimensions : mm

These series have been specially designed for high current, low voltage DC-DC converter applications.

This simple, rugged design provides current ratings normally available only in much larger packages – up to 16Arms for a .33 μ H part. With its tinned self-leaded construction, the SSL0804HC achieves very low DCR values and excellent solderability. In addition to the standard parts shown, custom values are also available.

These inductors are less than .2" (5mm) high. They have very low resistance and a rugged self-leaded construction.

Applications

- Notebook computers, Sep-up and step-down converters, memory programmers, etc...

ELECTRICAL CHARACTERISTICS

PART NO.	INDUCTANCE (μ H $\pm 20\%$)*	SRF (MHz)	DC RESISTANCE (Ω) Max.	I _{sat} ** (A)	I _{rms} *** (A)
SSLI306HC-R78M-S	0.78	156	2.6	30	15
SSLI306HC-1R5M-S	1.5	100	4.0	25	15
SSLI306HC-2R2M-S	2.2	75	6.1	20	12
SSLI306HC-3R3M-S	3.3	60	8.6	17	10
SSLI306HC-3R9M-S	3.9	55	10	15	9.0
SSLI306HC-4R7M-S	4.7	40	14	13	8.4
SSLI306HC-6R0M-S	6.0	35	17	12	7.5
SSLI306HC-7R8M-S	7.8	35	18	11	7.5
SSLI306HC-100M-S	10	28	26	10	6.0
SSLI306HC-150M-S	15	20	32	8	4.4

* L : Tested at 0.1 Vrms, 100 KHz (HP-4192A)

** I_{sat} : Inductance Drop = 10% Typ.

*** ΔT = 40°C Typ at I_{rms}.

Operating Temperature Range -40°C to +85°C



TAPE DIMENSIONS

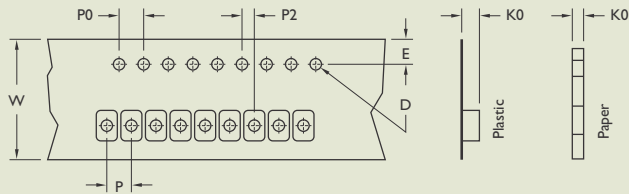

TAPE MATERIAL

Carrier Tape : Polystyrene

Cover Type : Polyethylene

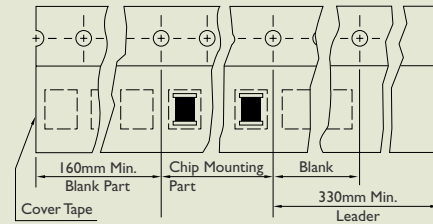

REEL DIMENSIONS

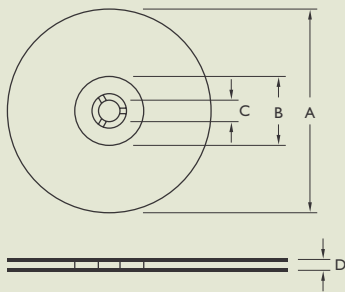

RECOMMENDED PATTERN

Land Pattern

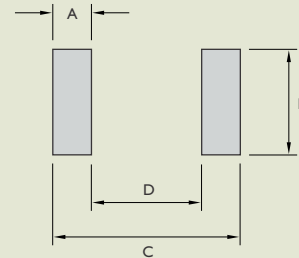

Dimensions : mm

TYPE	TAPE DIMENSIONS							RECOMMENDED PATTERN				REEL DIMENSIONS				QUANTITY /REEL	
	K0	D	E	W	P	P0	P2	UNIT	A	B	C	D	A	B	C		D
SSL0503HC	5.3	1.55	1.75	16	12	4	2	In	0.075	0.160	0.350	0.200	330	100	13	17.4	1000
								mm	1.91	4.06	8.89	5.08					
SSL0804HC	6.1	1.55	1.75	24	16	4	2	In	0.060	0.160	0.460	0.34	330	100	13	24.2	750
								mm	1.521	4.06	11.68	8.64					
SSL1306HC	7.2	1.55	1.75	44	24	4	2	In	0.125	0.340	0.820	0.560	330	100	13	45.4	250
								mm	3.18	8.64	20.71	14.35					



SSL SERIES RELIABILITY TEST

I-1 MECHANICAL PERFORMANCE

NO.	ITEM	SPECIFICATION	TEST CONDITIONS
I-1-1	Vibration	Appearance : No Damage L Change : within $\pm 10\%$ Q Change : within $\pm 30\%$ RDC : within Specification	Test device shall be soldered on the substrate. Oscillation Frequency : 10 to 55 to 10Hz for 1Min. Amplitude : 1.5mm Time : 2Hrs. for each Axis (X,Y & Z), Total 6Hrs.
I-1-2	Resistance to Soldering Heat	Appearance : No Damage	Pre-heating : 150°C, 1Min. Solder Composition : Sn/Pb = 63/37 Solder Temperature : 260 \pm 5°C Immersion Time : 10 \pm 1Sec.
I-1-3	Solderability	The electrodes shall be at least 90% covered with new solder coating.	Pre-heating : 150°C, 1Min. Solder Composition : Sn/Pb = 63/37 Solder Temperature : 230 \pm 5°C Immersion Time : 4 \pm 1Sec.

I-2 ENVIRONMENTAL PERFORMANCE

NO.	ITEM	SPECIFICATION	TEST CONDITIONS															
I-2-1	Temperature Shock	Appearance : No Damage L Change : within $\pm 10\%$ L Change : within $\pm 30\%$ RDC : within Specification	10 Cycles (Air to Air) Cycles shall Consist of : 30Min. Exposure to -55°C 30Min. Exposure to 125°C 15Sec. Max. Transition between Temperatures Measured after Exposure in the Room Condition for 24Hrs.															
I-2-2	Temperature Cycle		One Cycle <table border="1"> <thead> <tr> <th>Step</th> <th>Temperature (°C)</th> <th>Time (Min.)</th> </tr> </thead> <tbody> <tr> <td>1</td> <td>-25 \pm 3</td> <td>30</td> </tr> <tr> <td>2</td> <td>25 \pm 2</td> <td>3</td> </tr> <tr> <td>3</td> <td>85 \pm 3</td> <td>30</td> </tr> <tr> <td>4</td> <td>25 \pm 2</td> <td>3</td> </tr> </tbody> </table> Total : 100 Cycles Measured after Exposure in the Room Condition for 24Hrs.	Step	Temperature (°C)	Time (Min.)	1	-25 \pm 3	30	2	25 \pm 2	3	3	85 \pm 3	30	4	25 \pm 2	3
Step	Temperature (°C)	Time (Min.)																
1	-25 \pm 3	30																
2	25 \pm 2	3																
3	85 \pm 3	30																
4	25 \pm 2	3																
I-2-3	Humidity Resistance		Temperature : 40 \pm 2°C Relative Humidity : 90 ~ 95% Time : 1000Hrs. Measured after Exposure in the Room Condition for 24Hrs.															
I-2-4	High Temperature Resistance		Temperature : 85 \pm 3°C Relative Humidity : 20% Applied Current : Rated Current Time : 1000Hrs. Measured after Exposure in the Room Condition for 24Hrs.															
I-2-5	Low Temperature Resistance		Temperature : -25 \pm 3°C Relative Humidity : 0% Time : 1000Hrs. Measured after Exposure in the Room Condition for 24Hrs.															



TYPICAL ELECTRICAL CHARACTERISTICS

Curves of SSL Series

Test Instruments :

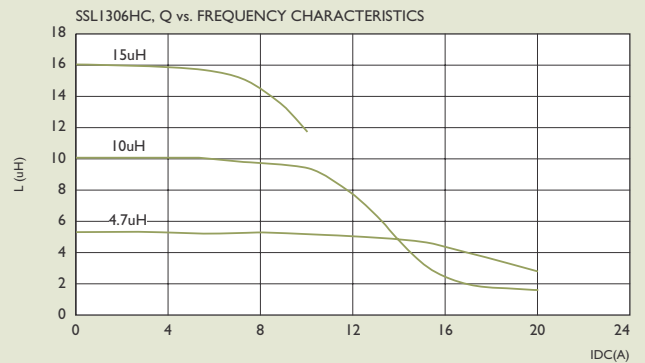
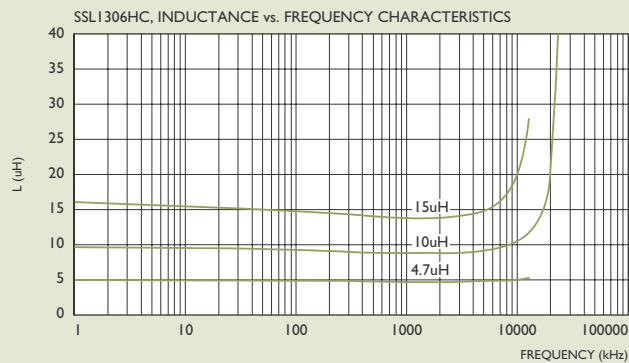
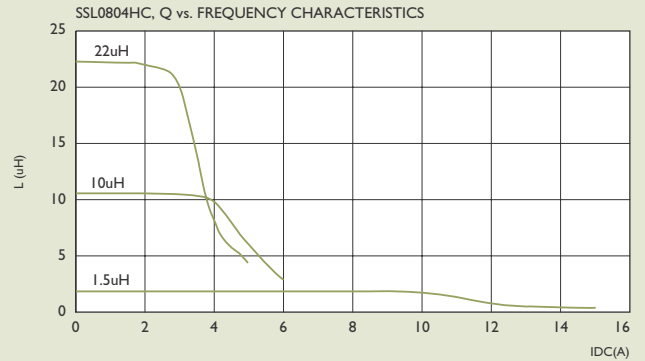
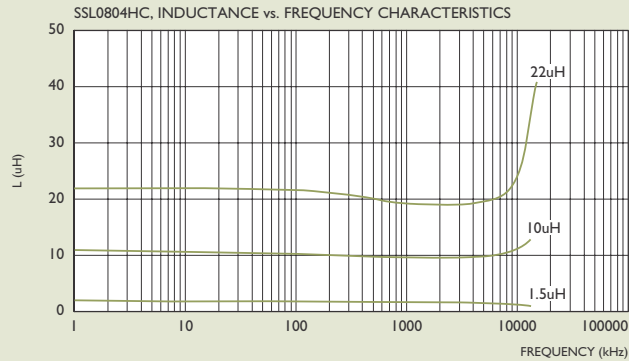
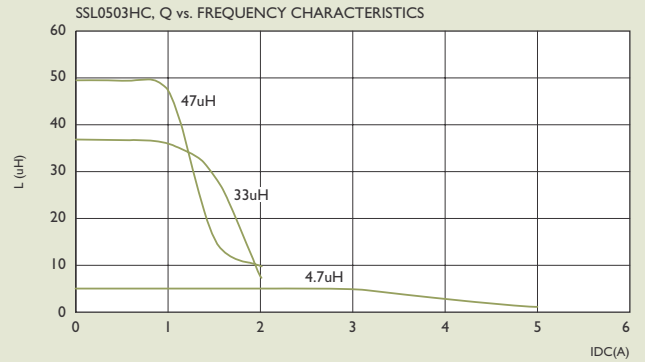
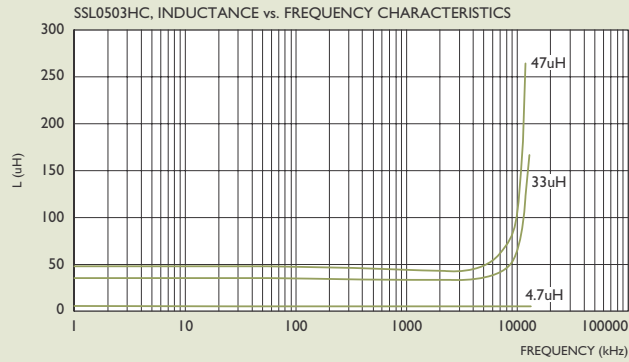

SMD Power Inductors

STD0804 Series



PRODUCT IDENTIFICATION

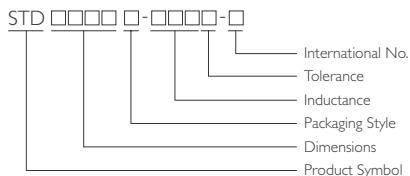

- Packaging: T: Tape and Reel
- Tolerance: M=±20%
- Note: YAGEO will start to release STD Series inductors with lead-free terminals which meet SONY SS-00259's criteria for lead-free product in Q2 of 2004, and YAGEO Internal No will be changed to "N" as identification. Ex. STD1109T-100M-B-N

SHAPES AND DIMENSIONS

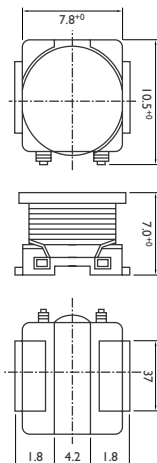

Dimensions : mm

Yageo SMD power inductors are best designed for noise / EMI / RFI filters for surface mounting applications.

These components contain tremendous electrode straight, solder heat resistance and outstanding solderability. These products are specially designed for flow, reflow and wave soldering required for surface mounting applications.

Applications

- Power supply, power amplifiers
- Switching regulators.

Features

- For high current applications.
- Specially designed for high density surface applications.
- Ideal for solder flow, reflow and wave soldering applications.

ELECTRICAL CHARACTERISTICS

PART NO.	INDUCTANCE * ($\mu\text{H} \pm 10\%$)	DC RESISTANCE (Ω^{+0})	RATED CURRENT (mA)
STD0804T-560K-S	56	0.25	900
STD0804T-680K-S	68	0.30	800
STD0804T-820K-S	82	0.37	700
STD0804T-101K-S	100	0.38	600
STD0804T-121K-S	120	0.58	550
STD0804T-151K-S	150	0.72	500
STD0804T-181K-S	180	0.80	450
STD0804T-221K-S	220	0.83	400
STD0804T-271K-S	270	1.10	350
STD0804T-331K-S	330	1.15	300

* Tested at HP4263A 1KHz, 1 Volt.

** Inductance Drop = 10% Typ. at Rated Isat.

Operating Temperature Range -40°C to +85°C

STD1109 Series

SMD Power Inductors

Yageo SMD power inductors are best designed for noise / EMI / RFI filters for surface mounting applications.

These components contain tremendous electrode straight, solder heat resistance and outstanding solderability. These products are specially designed for flow, reflow and wave soldering required for surface mounting applications.

Applications

- For high current applications.
- Specially designed for high density surface applications.
- Ideal for solder flow, reflow and wave soldering applications.

ELECTRICAL CHARACTERISTICS

PART NO.	INDUCTANCE ($\mu\text{H} \pm 20\%$)*	DC RESISTANCE (Ω)	RATED CURRENT (A) Max.
STD1109T-100M-B	10	0.06	3.50
STD1109T-120M-B	12	0.07	3.40
STD1109T-150M-B	15	0.08	3.10
STD1109T-180M-B	18	0.09	3.00
STD1109T-220M-B	22	0.10	2.60
STD1109T-270M-B	27	0.11	2.40
STD1109T-330M-B	33	0.12	2.30
STD1109T-390M-B	39	0.14	2.10
STD1109T-470M-B	47	0.17	1.95
STD1109T-560M-B	56	0.19	1.85
STD1109T-680M-B	68	0.22	1.65
STD1109T-820M-B	82	0.25	1.50
STD1109T-101M-B	100	0.35	1.40
STD1109T-121M-B	120	0.40	1.30
STD1109T-151M-B	150	0.47	1.20
STD1109T-181M-B	180	0.63	1.00
STD1109T-221M-B	220	0.73	0.95
STD1109T-271M-B	270	0.97	0.90
STD1109T-331M-B	330	1.15	0.80
STD1109T-391M-B	390	1.30	0.75
STD1109T-471M-B	470	1.48	0.65
STD1109T-561M-B	560	1.90	0.60
STD1109T-681M-B	680	2.45	0.50
STD1109T-821M-B	820	2.55	0.48
STD1109T-102M-B	1000	3.00	0.46
STD1109T-122M-B	1200	3.50	0.35

Test Instruments : HP4261 RF Impedance for L, IDC

Digital Multimeter SC-7401 for RDC

* Test at HP4263A 1KHz, 1Volt



Features

- Power supply, power amplifiers
- Switching regulators.

PRODUCT IDENTIFICATION

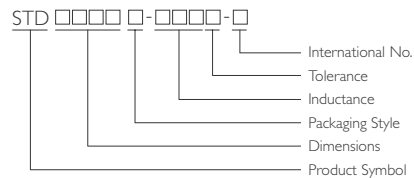

- Packaging: T: Tape and Reel
- Tolerance: M=±20%
- Note: YAGEO will start to release STD Series inductors with lead-free terminals which meet SONY SS-00259's criteria for lead-free product in Q2 of 2004, and YAGEO Internal No will be changed to "N" as identification. Ex. STD1109T-100M-B-N

SHAPES AND DIMENSIONS

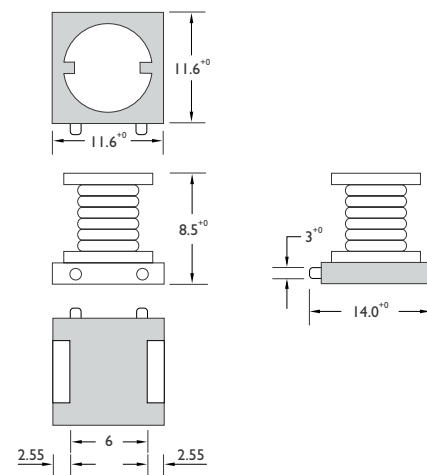



TAPE DIMENSIONS

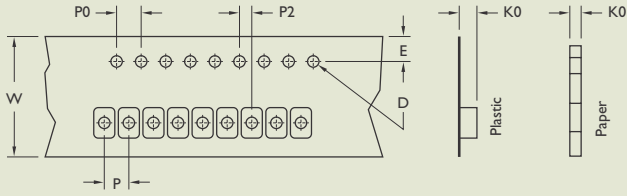

TAPE MATERIAL

Carrier Tape : Polystyrene

Cover Type : Polyethylene

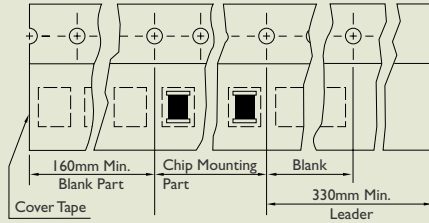

REEL DIMENSIONS

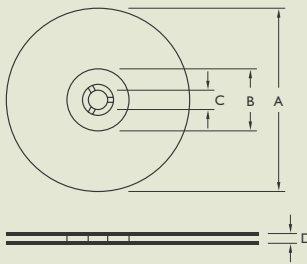

RECOMMENDED PATTERN

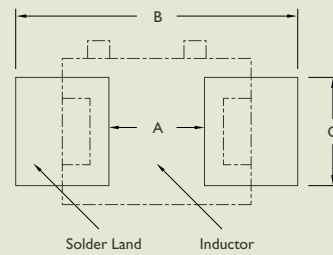

Dimensions : mm

TYPE	TAPE DIMENSIONS							RECOMMENDED PATTERN			REEL DIMENSIONS				QUANTITY /REEL
	K0	D	E	W	P	P0	P2	A	B	C	A	B	C	D	
STD0804	5.4	1.55	1.75	24	16	4	2	4.0	9	4.5	330	100	13	24.4	750
STD1109	8.7	1.55	1.75	24	20	4	2	6	12~14	5	330	100	13	24.4	400

TYPICAL INDUCTANCE ENERGY STORAGE VS. CURRENT

Test instruments : HP4191A RF Impedance Analyzer

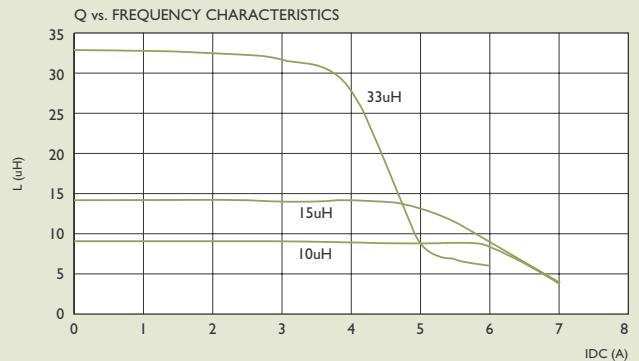
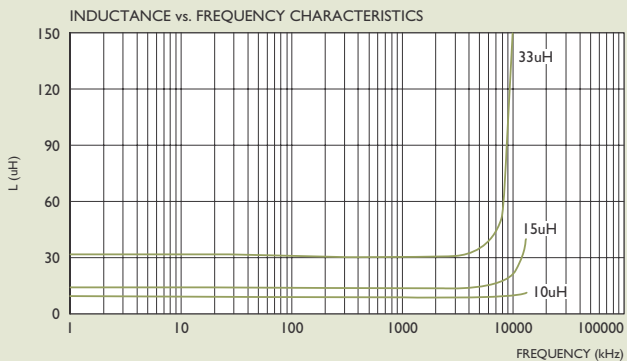



STD SERIES RELIABILITY TEST

I-1 MECHANICAL PERFORMANCE

NO.	ITEM	SPECIFICATION	TEST CONDITIONS
I-1-1	Vibration	Appearance : No Damage L Change : within $\pm 10\%$ Q Change : within $\pm 30\%$ RDC : within Specification	Test device shall be soldered on the substrate. Oscillation Frequency : 10 to 55 to 10Hz for 1Min. Amplitude : 1.5mm Time : 2Hrs. for each Axis (X,Y & Z), Total 6Hrs.
I-1-2	Resistance to Soldering Heat	Appearance : No Damage	Pre-heating : 150°C, 1Min. Solder Composition : Sn/Pb = 63/37 Solder Temperature : 260 \pm 5°C Immersion Time : 10 \pm 1Sec.
I-1-3	Solderability	The electrodes shall be at least 90% covered with new solder coating.	Pre-heating : 150°C, 1Min. Solder Composition : Sn/Pb = 63/37 Solder Temperature : 230 \pm 5°C Immersion Time : 4 \pm 1Sec.

I-2 ENVIRONMENTAL PERFORMANCE

NO.	ITEM	SPECIFICATION	TEST CONDITIONS															
I-2-1	Temperature Shock	Appearance : No Damage L Change : within $\pm 10\%$ L Change : within $\pm 30\%$ RDC : within Specification	10 Cycles (Air to Air) Cycles shall Consist of : 30Min. Exposure to -55°C 30Min. Exposure to 125°C 15Sec. Max. Transition between Temperatures Measured after Exposure in the Room Condition for 24Hrs.															
I-2-2	Temperature Cycle		One Cycle <table border="1"> <thead> <tr> <th>Step</th> <th>Temperature (°C)</th> <th>Time (Min.)</th> </tr> </thead> <tbody> <tr> <td>1</td> <td>-25 \pm 3</td> <td>30</td> </tr> <tr> <td>2</td> <td>25 \pm 2</td> <td>3</td> </tr> <tr> <td>3</td> <td>85 \pm 3</td> <td>30</td> </tr> <tr> <td>4</td> <td>25 \pm 2</td> <td>3</td> </tr> </tbody> </table> <p>Total : 100 Cycles Measured after Exposure in the Room Condition for 24Hrs.</p>	Step	Temperature (°C)	Time (Min.)	1	-25 \pm 3	30	2	25 \pm 2	3	3	85 \pm 3	30	4	25 \pm 2	3
Step	Temperature (°C)	Time (Min.)																
1	-25 \pm 3	30																
2	25 \pm 2	3																
3	85 \pm 3	30																
4	25 \pm 2	3																
I-2-3	Humidity Resistance		Temperature : 40 \pm 2°C Relative Humidity : 90 ~ 95% Time : 1000Hrs. Measured after Exposure in the Room Condition for 24Hrs.															
I-2-4	High Temperature Resistance		Temperature : 85 \pm 3°C Relative Humidity : 20% Applied Current : Rated Current Time : 1000Hrs. Measured after Exposure in the Room Condition for 24Hrs.															
I-2-5	Low Temperature Resistance		Temperature : -25 \pm 3°C Relative Humidity : 0% Time : 1000Hrs. Measured after Exposure in the Room Condition for 24Hrs.															